

**Priorities, Gaps and Opportunities:  
Towards A Long-Range Strategic Plan For  
Magnetic Fusion Energy**

---

A Report to the Fusion Energy Sciences Advisory Committee  
October 2007

---



## Table of Contents

Executive Summary .....	5
Summary Of Findings And Recommendations .....	9
Chapter 1 Introduction and Background .....	21
1.a. Discussion of Charge.....	21
1.b. Scope of the Panel’s Work .....	21
1.c. Recent Planning Exercises and Reviews .....	23
1.d Discussion of Demo and Characteristics.....	23
1.e Approach Taken By Panel And Organization Of Report .....	24
Chapter 2 Scientific and Technical Questions on the Road Toward Demo .....	27
2.a. Themes and Issues .....	27
2.b. Detailed Discussion of the Issues.....	30
2.c Prioritization .....	70
2.d U.S. Strengths and Opportunities.....	72
Chapter 3 Assessment of Available Means To Address Issues .....	75
3.a. ITER .....	75
3.b Other Existing and Planned Confinement Experiments.....	81
3.c. Large Scale Modeling Projects.....	114
3.d. Technology facilities including IFMIF .....	119
3.e. International Fusion Development Plans.....	138
Chapter 4 Analysis of Gaps.....	151
4.a. Approach .....	151
4.b. Compilation of fine-scale gaps and mission elements .....	151
4.c. Discussion of overarching issues.....	181
4.d. High-level organization of gaps .....	182
Chapter 5 New Facilities, Initiatives and Programs .....	189
5.a. Synthesis.....	189
5.b. Table of possible major initiatives, facilities and programs.....	190
5.c. Relation of initiatives to gaps .....	191
5.d. Resource Requirements And Risk Management.....	196
Appendices .....	197
A. Charge Letter .....	197
B. Panel Roster .....	199
C. Panel Process and Meetings .....	199
D. Community White Papers .....	200
E. Community Workshops and Presentations .....	202



## Executive Summary

The formal start of the ITER project provides a unique vantage point from which to reflect on the present and future of the U.S. magnetic fusion energy program. The construction and operation of ITER will represent the fulfillment of a decades-long undertaking to demonstrate the technical feasibility of fusion power, building on a remarkable period of progress, scientific achievement and discovery. At the same time, it is clear that ITER will not resolve all of the scientific and technical questions that remain on the road toward practical fusion energy. For the U.S. to exploit the knowledge gained on ITER, it is worthwhile to consider other research activities, to be carried out in parallel with and following the ITER project. This report summarizes a six month study of opportunities available to the program as it considers the path from ITER, toward Demo. It seeks to answer the charge given to FESAC by undersecretary Orbach in March 2007.

“To assist planning for the ITER era, it is critical that FESAC identify the issues arising in a path to DEMO, with ITER as a central part of that effort

1. Identify and prioritize the broad scientific and technical questions to be answered prior to a DEMO.
2. Assess available means (inventory), including all existing and planned facilities around the world, as well as theory and modeling, to address these questions.
3. Identify research gaps and how they may be addressed through new facility concepts, theory and modeling.”

The charge assumed a fusion energy development scenario with a direct path from ITER to Demo based on the tokamak and its low-aspect ratio and advanced variants. Stellarator issues were also reviewed, as it is the next most developed concept and operates intrinsically steady-state and without disruptions – two critical issues for the tokamak. The charge asked for priorities, but did not ask for a review of the entire program. In particular, it did not ask the panel to assess the research program necessary to make ITER and U.S. participation a success, though it is clear that this is the top priority of the U.S. program. Other elements, such as inertial confinement, were excluded and alternate magnetic concepts were considered only to the extent that they could influence or facilitate, in a significant way, the main-line sequence from ITER to Demo. The charge anticipated additional planning activities that would consider specific major facilities and programs and include parts of the program not within the scope of this one. Comparative judgments have not been made between the activities covered in this report and those excluded from consideration.

The scope of this report extends over several decades, but the panel’s main intent is to inform decisions about major next steps in the U.S. program. In the report, we hope to provide the groundwork for those decisions, to lay out options and to place the near-term

## Draft FESAC sub-panel report – Do not circulate

research program into the context of long-term needs and directions. Long-term plans will certainly be reviewed and revised many times before a fusion reactor is proposed. Finally, while the charge is placed in an international context, it seeks avenues for U.S. leadership and challenges our community to be ready for a Demo built in the U.S. if and when that decision is made.

The panel sought to identify the scientific questions and technical challenges likely to remain after the successful completion of current and planned research, including ITER, and to formulate major research initiatives that could answer those questions and confront those challenges. Consistent with the overall mission of the Office of Fusion Energy, the aim was to outline new program elements that are required to provide the knowledge base to enable an eventual step to Demo. In addressing the charge, the panel:

- 1) Identified 14 broad scientific questions, organized into three general themes (Findings 1 and 2).
- 2) Prioritized these issues as to their importance for fusion energy, urgency and generality (Finding 3)
- 3) Analyzed the full breadth of the world program including specific missions and capabilities of major facilities (Finding 4)
- 4) Assessed U.S. strengths and opportunities (Finding 5)
- 5) Summarized gaps in our knowledge on a path to Demo (Finding 6)
- 6) Identified research activities that could fill the gaps (Chapter 4)

A full and detailed set of findings can be found in the following chapter. Technical backup is provided in chapters 2-4.

The panel found that remarkable progress has been made by the program. The current approach, based on developing the scientific bases and significant predictive capability has been responsible for this progress and underpins our vision for the future. It is worth quoting a passage from the recent NRC report, *Plasma Science: Advancing Knowledge in the National Interest*, “The scientific opportunities in magnetic fusion science are compelling, intellectually challenging, and a direct product of the scientific focus of the U.S. magnetic fusion program over the past decade.” At the same time, we recognize significant challenges that remain and have outlined those in this report. And while the issues in front of us are at least as difficult as those that have been overcome, the panel is optimistic about the prospects for resolving remaining issues, given adequate resources.

As such, the panel recommends:

- 1) A long-term and detailed strategic plan should be developed and implemented as soon as possible to meet the challenges identified in this report. The plan should include metrics to prioritize research, scientific milestones to judge progress, and should identify ways to educate and train a new generation of scientists.
- 2) The plan should recognize and address all scientific challenges of fusion energy including fusion engineering, materials sciences and plasma physics.

## Draft FESAC sub-panel report – Do not circulate

- 3) Such a plan should include bold steps and encourage adoption of major new initiatives or construction of new facilities in order to resolve scientific challenges.
- 4) The panel has identified 9 potential initiatives, ranging from targeted research on key topics in fusion science and engineering to large, integrated plasma experiments exploring aspects of the fusion reactor environment.

The detailed set of recommendations can be found in the following chapter.





## Summary Of Findings And Recommendations

### Findings

Charge 1 requires that we identify the broad scientific and technical questions that must be answered before we are ready to proceed to Demo. Together, these questions should define the challenges ahead and set the long-term research agenda for the U.S. In carrying out its work, the panel reviewed all aspects of fusion systems that would be required for Demo, attempted to identify all of the critical issues, then organized these into logical categories. The panel also recognized a set of overarching issues, which were entwined with almost all of the others and which, in many cases, explicitly or implicitly drive research in other areas. The overarching issues describe necessary characteristics of an overall fusion system and include availability, maintainability, reliability, economics and safety.

#### **Finding 1. Achieving the required state of knowledge**

The panel found that remarkable progress has been made by the program but recognized that formidable challenges remain. While the issues in front of us are at least as difficult as those that have been overcome, the panel is optimistic about the prospects for resolving remaining issues, given adequate resources.

#### **Finding 2. Broad scientific and technical questions**

The panel identified a set of scientific and questions organized into three broad themes. The themes were defined in terms of knowledge required prior to Demo. In the definitions, we insist that the knowledge gained must be based on sound scientific principles and rigorously tested in the laboratory so that the step to a demonstration power reactor would be taken with high confidence of success. Similarly, each question was accompanied by a concrete definition and substantial backup detail (which can be found in chapter 2.) The particular decomposition and organization of issues chosen is clearly not unique, but was designed to aid in answering subsequent parts of the charge. The themes and questions identified were:

Theme A. Creating predictable high-performance steady-state plasmas: *The state of knowledge must be sufficient for the construction, with high confidence, of a device that permits the creation of sustained plasmas that meet simultaneously, all the conditions required for practical production of fusion energy.*

1. Measurement: *Make advances in sensor hardware, procedures and algorithms for measurements of all necessary plasma quantities with sufficient coverage and accuracy needed for the scientific mission, especially plasma control.*

## Draft FESAC sub-panel report – Do not circulate

2. Integration of high-performance, steady-state, burning plasmas: *Create and conduct research, on a routine basis, of high performance core, edge and SOL plasmas in steady-state with the combined performance characteristics required for Demo.*

3. Validated Predictive Modeling: *Through developments in theory and modeling and careful comparison with experiments, develop a set of computational models that are capable of predicting all important plasma behavior in the regimes and geometries relevant for practical fusion energy.*

4. Control: *Investigate and establish schemes for maintaining high-performance, burning plasmas at a desired, multivariate operating point with a specified accuracy for long periods, without disruption or other major excursions. (Provision for sensors is included under issue 1 and for actuators under issue 6.)*

5. Off-normal Plasma Events: *Understand the underlying physics and control of high-performance magnetically confined plasmas sufficiently so that 'off-normal' plasma operation, which could cause catastrophic failure of internal components, can be avoided with high reliability and/or develop approaches that allow the devices to tolerate some number or frequency of these events. (Because of their implications and importance, these 'off-normal events' are called out separately from the control issues listed above).*

6. Plasma Modification by Auxiliary Systems: *Establish the physics and engineering science of auxiliary systems that can provide power, particles, current and rotation at the appropriate locations in the plasma at the appropriate intensity.*

7. Magnets: *Understand the engineering and materials science needed to provide economic, robust, reliable, maintainable magnets for plasma confinement, stability and control.*

Theme B. Taming the Plasma Material Interface: *The state of knowledge must be sufficient to design and build, with high confidence, robust material components that interface the hot plasma in the presence of very high neutron fluences.*

8. Plasma-Wall Interactions: *Understand and control of all processes that couple the plasma and nearby materials.*

9. Plasma Facing Components: *Understand the materials and processes that can be used to design replaceable components that can survive the enormous heat, plasma and neutron fluxes without degrading the performance of the plasma or compromising the fuel cycle.*

## Draft FESAC sub-panel report – Do not circulate

10. RF Antennas, Launching Structures and Other Internal Components: *Establish the necessary understanding of plasma interactions, neutron loading and materials to allow design of RF antennas and launchers, control coils, final optics and any other diagnostic equipment that can survive and function within the plasma vessel.*

Theme C. Harnessing fusion power: *The state of knowledge must be sufficient to design and build, with high confidence, robust and reliable systems that can convert fusion products to useful forms of energy in a reactor environment, including a self-sufficient supply of tritium fuel.*

11. Fusion Fuel Cycle: *Learn and test how to manage the flow of tritium throughout the entire plant, including breeding and recovery.*

12. Power Extraction: *Understand how to extract fusion power at temperatures sufficiently high for efficient production of electricity or hydrogen.*

13. Materials Science in the Fusion Environment: *Understand the basic materials science for fusion breeding blankets, structural components, plasma diagnostics and heating components in high neutron fluence areas.*

14. Safety: *Demonstrate the safety and environmental potential of fusion power to preclude the technical need for a public evacuation plan, and to minimize the environmental burdens of radioactive waste, mixed waste, or chemically toxic waste for future generations.*

The first charge also asked for prioritization of the issues that had been identified. While not defining precisely what was meant by the term, it seems clear that the charge was seeking guidance on which areas would benefit most from additional emphasis or investment. As the panel developed the list of issues, it was clear that none were unimportant and that all would have to be resolved eventually. Thus it is crucial for readers to understand that the panel's judgments on priorities should not be taken as a recommendation to abandon certain broad lines of research. Rather, they are meant to inform decisions concerning which areas to stress now. Some level of research will be needed in all key areas to ensure the knowledge required for a step toward Demo is available.

### **Finding 3. Priorities**

All the issues listed above must be addressed and resolved before Demo. What distinguishes them is the timeline required to obtain answers, uncertainties about which paths would lead to success and the amount of effort that will be needed. The panel notes the desire of program managers to maximize the speed with which commercial fusion energy is attained, while minimizing overall risk within a realistic budget. The aim of the prioritization is to provide guidance on which areas to stress and the timing for the most productive investments, noting that some ongoing effort is required in all of the areas identified. It is also important to note that since there

## Draft FESAC sub-panel report – Do not circulate

are many important interactions and couplings between the issues, they cannot be addressed in complete isolation.

The panel ranked the issues using three criteria:

1. Importance: *Importance for the fusion energy mission and the degree of extrapolation from the current state of knowledge*
2. Urgency: *Based on level of activity required now and in the near future.*
3. Generality: *Degree to which resolution of the issue would be generic across different designs or approaches for Demo.*

After evaluation, the issues were grouped into three tiers, with the tiers defined to suggest an overall judgment on the state of knowledge and the relative requirement and timeliness for more intense research for each issue. The results of prioritization were:

**Tier 1:** *solution not in hand, major extrapolation from current state of knowledge, need for qualitative improvements and substantial development for both short and long term*

Plasma Facing Components  
Materials

**Tier 2:** *solutions foreseen but not yet achieved, major extrapolation from current state of knowledge, need for qualitative improvements and substantial development for long term*

Off-normal events  
Fuel cycle  
Plasma-wall interactions  
Integrated, high performance burning plasmas  
Power extraction  
Predictive modeling  
Measurement

**Tier 3:** *solutions foreseen but not yet achieved, moderate extrapolation from current state of knowledge, need for quantitative improvements and substantial development for long term*

RF launchers and other internal components  
Plasma modification by auxiliary systems  
Control  
Safety and environment  
Magnets

To answer charge 2, the panel gathered information on the missions, capabilities and schedules for current and planned programs, then evaluated U.S. strengths and opportunities to contribute in each of the 14 broad areas. While it was clear that the international program is very strong and that unnecessary duplication should be avoided, the panel felt that the

## Draft FESAC sub-panel report – Do not circulate

U.S. should not shrink from competing where we have the ability to make strong contributions. We evaluated the U.S. position with respect to four questions. 1. What were areas of current and historical U.S. strength or leadership? 2. In what areas was the U.S. in greatest danger of losing leadership or competitiveness given current trends? 3. What were areas where the U.S. had an opportunity to sustain leadership by strategic investment? 4. In what areas could the U.S. gain leadership by making significant new investments?

### **Finding 4. Scope of world program**

The panel noted that the issues identified in this report were widely recognized in the domestic and international fusion programs, providing ample opportunities to collaborate on their resolution. However, the U.S. fraction of the world program is decreasing and the ability to partner effectively or to compete for leadership may be threatened in the future without adequate U.S. investment.

### **Finding 5. U.S. Strengths and opportunities**

The panel assessed current U.S. strength and tried to identify areas where additional investment would be most effective with respect to the international program.

a) In evaluating areas of current strength, the panel felt that the U.S. could claim leadership in:

- Measurement
- Predictive modeling
- Control

b) That the U.S. was strongly competitive in:

- Plasma wall interactions
- Integrated, sustained, high-performance plasmas
- Safety/environment

c) That the U.S. was at risk of losing leadership or competitiveness in many areas, particularly:

- Measurement
- Control
- Antennas and launchers
- Materials
- Integrated, sustained, high-performance plasmas
- Plasma-wall interactions and Plasma facing components
- Safety
- Magnets

d) That there were areas where investment could sustain strength:

- Measurement
- Predictive modeling
- Control
- Plasma-wall interactions

e) That investment could provide new opportunities for U.S. leadership in:

- Plasma facing components
- Materials

## Draft FESAC sub-panel report – Do not circulate

f) That while there are major world research efforts to avoid off-normal plasma events in tokamaks, U.S. strengths in three-dimensional physics and modeling provide an opportunity for an alternate resolution of this issue via exploitation of quasi-symmetric helical shaping.

g) That there was, nonetheless, a need to maintain core competencies in all relevant areas. Clearly the U.S. will be working with and relying on foreign programs for the foreseeable future, however, maintaining some level of core competency in all areas is a prerequisite for effective partnership and a necessity if the U.S. is to build the knowledge base for a step to Demo.

As the set of broad questions was developed in response to the first part of the charge, considerable detail was amassed concerning the scientific and technical issues that will need to be addressed and the extrapolation required from the current state of knowledge. To address charge 3, these finer-scale issues were considered in light of existing and planned programs and a fine-granularity set of gaps was compiled. This list represents gaps in our knowledge that are likely to remain, with some reasonable probability, even after completion of the world-wide research program that is currently underway or in the pipeline. Success for the basic ITER mission was assumed, but it is not possible, of course, to predict with certainty, the results of scientific research, so this assessment represents only the best guesses and judgments of the panel.

### **Finding 6. Evaluation of current and planned programs and summary of gaps**

By considering extrapolations in our scientific and technical understanding and in machine performance in all of the identified areas, and comparing these against the research plans in current and planned programs, the panel derived a set of gaps in our knowledge base that would likely remain when all of these programs were complete. (Details for this analysis can be found in chapters 2, 3 and 4.) The gaps were first compiled at a fine level of granularity (section 4b) then consolidated into 15 categories. These areas are similar, but not identical, to the list of scientific questions found in chapter 2, however there is a crucial distinction. The consolidated gaps have been heavily filtered in the process, leaving a smaller subset of each original issue. This difference can only be fully appreciated by carefully reading section 4d, which summarizes the residual issues in each category. The most significant gaps were:

G-1. Sufficient understanding of all areas of the underlying plasma physics to predict the performance and optimize the design and operation of future devices. Areas likely to require additional research include turbulent transport and multi-scale, multi-physics coupling.

G-2. Demonstration of integrated, steady-state, high-performance (advanced) burning plasmas, including first wall and divertor interactions. The main challenge is combining high fusion gain with the strategies needed for steady-state operation.

## Draft FESAC sub-panel report – Do not circulate

G-3. Diagnostic techniques suitable for control of steady-state advanced burning plasmas that are compatible with the nuclear environment of a reactor. The principle gap here is in developing measurement techniques that can be used in the hostile environment of a fusion reactor.

G-4. Control strategies for high-performance burning plasmas, running near operating limits, with auxiliary systems providing only a small fraction of the heating power and current drive. Innovative strategies will be required to implement control in high-Q burning plasma where almost all of the power and the current drive is generated by the plasma itself.

G-5. Ability to predict and avoid, or detect and mitigate, off-normal plasma events that could challenge the integrity of fusion devices.

G-6. Sufficient understanding of alternative magnetic configurations that have the ability to operate in steady-state without off-normal plasma events. These must demonstrate, through theory and experiment, that they can meet the performance requirements to extrapolate to a reactor and that they are free from off-normal events or other phenomena that would lower their availability or suitability for fusion power applications.

G-7. Integrated understanding of RF launching structures and wave coupling for scenarios suitable for Demo and compatible with the nuclear and plasma environment. The stresses on launching structures for ICRH or LHCD in a high radiation, high heat-flux environment will require designs that are less than optimal from the point of view of wave physics and that may require development of new RF techniques, new materials and new cooling strategies.

G-8. The knowledge base required to model and build low and high-temperature superconducting magnet systems that provide robust, cost-effective magnets (at higher fields if required).

G-9. Sufficient understanding of all plasma-wall interactions necessary to predict the environment for, and behavior of, plasma facing and other internal components for Demo conditions. The science underlying the interaction of plasma and material needs to be significantly strengthened to allow prediction of erosion and re-deposition rates, tritium retention, dust production and damage to the first wall.

G-10. Understanding of the use of low activation solid and liquid materials, joining technologies and cooling strategies sufficient to design robust first-wall and divertor components in a high heat flux, steady-state nuclear environment. Particularly challenging issues will include tritium permeation and retention, embrittlement and loss of heat conduction.

## Draft FESAC sub-panel report – Do not circulate

G-11. Understanding the elements of the complete fuel cycle, particularly efficient tritium breeding, retention, recovery and separation in vessel components.

G-12. An engineering science base for the effective removal of heat at high temperatures from first wall and breeding components in the fusion environment.

G-13. Understanding the evolving properties of low activation materials in the fusion environment relevant for structural and first wall components. This will include the effects of materials chemistry and tritium permeation at high-temperatures. Important properties like dimensional stability, phase stability, thermal conductivity, fracture toughness, yield strength and ductility must be characterized as a function of neutron bombardment at very high levels of atomic displacement with concomitant high levels of transmutant helium and hydrogen.

G-14. The knowledge base for fusion systems sufficient to guarantee safety over the plant life cycle - including licensing and commissioning, normal operation, off-normal events and decommissioning/disposal.

G-15. The knowledge base for efficient maintainability of in-vessel components to guarantee the availability goals of Demo are achievable.

### **Finding 7. Mitigation of programmatic risks through breadth of program including international collaboration**

The principle strategy to mitigate risk is to implement a sufficiently broad program so that alternative approaches or technologies are available at each step. Any research program, no matter how carefully planned may not provide the information or knowledge at the time it is needed to take the next logical step in development. One goal of a strategic plan for fusion would be to maximize the chance that the required information is available by providing deep scientific foundations for the necessary disciplines and by pursuing multiple research paths where uncertainties are greatest. It is clear that there is a direct trade-off between risks and costs and that budgets will always require making choices about which lines of research to follow. One important set of choices for the U.S. program involves deciding which issues to address through international collaboration and which to take on itself.

### **Finding 8. Importance of maintaining support for ITER**

Success on ITER must be the overall top priority for the fusion program. While considering the recommendations in this report, the panel reiterates the importance of maintaining support for ITER within its domestic program.



### Recommendations

The panel wanted to go on record as supporting the development of a comprehensive strategic plan for MFE and encouraged the bold new vision that is implicit in the charge. It was also apparent to the panel, that fundamental physical sciences research will be required to answer the challenges contained in areas traditionally designated as “technology”. The panel urges that these areas not be overlooked in future planning exercises. These areas are also critical as enablers of fusion plasma research as they expand options for design of new experiments.

**Recommendation 1. A long-term strategic plan should be developed and implemented as soon as possible to begin addressing the gaps identified in this report.**

Such a plan should include metrics to prioritize research areas, scientific milestones to judge the progress, and should identify means to educate and train a new generation of scientists.

**Recommendation 2. Such a strategic plan should recognize and address all scientific challenges of fusion energy including fusion engineering, materials sciences and plasma physics.**

It is clear from the identification of issues, priorities and gaps that there are many important scientific questions that are not directly or entirely related to plasma physics. Well before we are prepared for the step to Demo, a comprehensive research program will be needed to answer these questions. Of particular importance would be ongoing research to explore innovative approaches in many areas. The fusion program can't wait until the detailed design of new experiments has begun, since options must be available as plans are formulated.

**Recommendation 3. A long-term strategic plan needs to include bold steps**

The panel encourages the adoption of new initiatives or the construction of new facilities that are vital in filling the gaps identified in this report and that can hold their own in the international arena.

To complete work on charge 3, the panel derived a lengthy set of “mission elements” from the compilation of gaps. These are research activities, usually many more than one per gap, which could provide the required knowledge base. From these, a set of major initiatives is proposed, each representing an opportunity, with appropriate investment, for U.S. leadership in the world program. Most could be carried out with substantial international collaboration, or could be led by an international partner with substantial U.S. involvement. Each makes a dominant contribution to at least one of the identified gaps and typically secondary contributions to several others. A sense of the priority of each initiative can be gained by considering the priorities of the issues that are addressed.

In some cases more than one initiative is listed to address a particular gap. For example, a major effort to enhance the advanced tokamak program on ITER has a similar goal as a new major facility aimed at investigating the same science. Only one of these would be

## Draft FESAC sub-panel report – Do not circulate

necessary, in our judgment, to provide the information required to go forward with a Demo based on AT physics. The choice between the alternatives would be based on technical, political and economic factors. It may be also possible or desirable to combine the missions of two or more of the facilities listed below into a single, larger initiative, though only after careful consideration of costs and benefits. The potential for each initiative to fill identified gaps is summarized in figure 1.

**Recommendation 4. The development of a long-term strategic plan should include careful consideration of the following nine major initiatives.** [note these are not listed in priority order]

I-1. Initiative toward predictive plasma modeling and validation

This activity describes a coordinated program that would combine major advances in advanced physics based plasma simulations, especially multi-scale, multi-physics issues combined with a vigorous effort to validate these models against large and small-scale experiments. A critical element would be the development and deployment of new measurement techniques.

I-2. Extensions to ITER AT capabilities

This initiative would entail new or enhanced drivers (heating, current drive, etc.), control tools and diagnostics capable of carrying out a comprehensive AT physics program. The aim would be to achieve an understanding of burning AT regimes sufficient to base Demo on.

I-3. Integrated advanced burning physics demonstration

This facility would be a dedicated sustained, high-performance burning plasma experiment with a goal to achieve an understanding sufficient to base Demo on. It is predicated on the condition that extensions to the ITER AT program and predictive understanding from the international superconducting tokamaks will not achieve an understanding sufficient for extrapolation to Demo.

I-4. Integrated experiment for plasma wall interactions and plasma facing components

This very-long pulse or steady-state confinement experiment would perform research on plasma wall interactions and plasma facing components in a non-DT integrated facility. It would attempt to duplicate and study, as closely as possible, all of the issues and (non-nuclear) problems that PWI/PFCs would face in a reactor.

I-5. Advanced experiment in disruption-free concepts

This would be a performance extension device for a concept that had demonstrated promise for fusion applications by projecting to high performance and efficient steady state, and which was significantly less susceptible to off-normal events compared to a tokamak. A stellarator would be the mostly likely candidate for such a facility.

## Draft FESAC sub-panel report – Do not circulate

### I-6. Engineering and materials physics modeling and experimental validation initiative

This would be a coordinated and comprehensive research program consisting of advanced computer modeling and laboratory testing aimed at establishing the single-effects science for major fusion technology issues, including materials, plasma-wall interactions, plasma-facing components, joining technologies, super-conducting magnets, tritium breeding, RF and fueling systems.

### I-7. Materials qualification facility

This initiative would involve testing and qualification of low-activation materials by intense neutron bombardment. The facility generally associated with this mission is the International Fusion Materials Irradiation Facility (IFMIF). The potential for a dedicated spallation neutron source irradiation facility to reduce or possibly eliminate the need for the US to participate as a full partner in IFMIF needs to be assessed.

### I-8. Component development and testing program

This would entail coordinated research and development for multi-effect issues in critical technology areas. Examples are breeding/blanket modules and first wall components but this initiative could include other important components like magnet systems or RF launchers. This program would most likely be carried out as enabling research in direct preparation and support of planned nuclear fusion facilities such as ITER, CTF or Demo.

### I-9. Component qualification facility

This facility is aimed at testing and validating plasma and nuclear technologies in a high availability, high heat flux, high neutron fluence DT device. It would qualify components for Demo and establish the basis for licensing. In fusion energy development plans, this machine is called a Component Test Facility (CTF).

## How Initiatives Could Address Gaps

### Legend

Major Contribution	3
Significant Contribution	2
Minor Contribution	1
No Important Contribution	

	G-1 Plasma Predictive capability	G-2 Integrated plasma demonstration	G-3 Nuclear-capable Diagnostics	G-4 Control near limits with minimal power	G-5 Avoidance of Large-scale Off-normal events in tokamaks	G-6 Developments for concepts free of off-normal plasma events	G-7 Reactor capable RF launching structures	G-8 High-Performance Magnets	G-9 Plasma Wall Interactions	G-10 Plasma Facing Components	G-11 Fuel cycle	G-12 Heat removal	G-13 Low activation materials	G-14 Safety	G-15 Maintainability
I-1. Predictive plasma modeling and validation initiative	3	2		2	2	3	1		2						
I-2. ITER – AT extensions	3	3	3	3	3		2	2	2	2	1	1		1	1
I-3. Integrated advanced physics demonstration (DT)	3	3	3	3	3	1	3	2	3	3	1	1	1	1	1
I-4. Integrated PWI/PFC experiment (DD)	2	1		1	2		2	1	3	3	1	1		1	1
I-5. Disruption-free experiments	2	1		2	1	3		1	1	1					
I-6. Engineering and materials science modeling and experimental validation initiative							1	3	1	3	2	3	3	2	1
I-7. Materials qualification facility							1			3	2	1	3	3	
I-8. Component development and testing			1				2	1		3	3	3	2	2	2
I-9. Component qualification facility	1	1	2	1	2		3	2	2	3	3	3	3	3	3

Fig 1. To what extent does each proposed initiatives (rows) address the important gaps (columns)

## Chapter 1 Introduction and Background

### 1.a. Discussion of Charge

With the approval of ITER, the magnetic fusion program has entered an exciting new era in which scientific and technological progress, gained over long years of research, will be brought to fruition. At the same time, it is understood that ITER will not resolve all of the issues in front of us. In this context, FESAC has been charged to identify gaps still remaining in the international program and major program elements which could augment existing and planned activities in building the knowledge base required for fusion energy. The relevant portion of the charge letter reads:

“To assist planning for the ITER era, it is critical that FESAC identify the issues arising in a path to Demo, with ITER as a central part of that effort”

1. Identify and prioritize the broad scientific and technical questions to be answered prior to a Demo.
2. Assess available means (inventory), including all existing and planned facilities around the world, as well as theory and modeling, to address these questions.
3. Identify research gaps and how they may be addressed through new facility concepts, theory and modeling.”

These questions ask in effect, “what do we need to learn and what do we need to do, aside from ITER and other current programs, so that we would be prepared to take the step to Demo?” This is not an exercise in designing or planning Demo, but in identifying the knowledge base that Demo would be based on and outlining the research program necessary to obtain it. It is understood that the panel’s efforts are meant primarily to inform near-term decisions about major next steps in the U.S. program. Long-term plans will certainly be revisited many times before a fusion reactor is proposed. However, in taking the next step, it is prudent to consider the entire path. Finally, while the charge is placed in an international context, it seeks opportunities for U.S. leadership and challenges the program to be ready for a Demo built in the U.S. if and when that decision comes from policy makers. The panel viewed this as an opportunity to expand our vision for the fusion program and to look toward a future where the U.S. is at the forefront of this critical and exciting field.

### 1.b. Scope of the Panel’s Work

In discussions with program leaders from OFES and OSC, the scope and boundaries of the charge were clarified. The charge was meant to cover a “mainline”, two-step

## Draft FESAC sub-panel report – Do not circulate

approach to fusion with ITER followed by Demo as the major elements. In defining gaps in the fusion research program, the panel assumes that ITER will successfully carry out its burning plasma mission. Demo is intended as a pre-commercial, electricity-producing reactor, demonstrating high availability and all relevant technologies and realizing the environmental and safety features inherent in fusion. A more complete discussion of Demo can be found below in section 1.d. The charge foresees no other reactor-scale device intervening between ITER and Demo, though smaller, but still significant facilities, may be required. The charge asks the panel to assume that ongoing and planned research, including ITER, meet its basic objectives, but recognizes that these programs, by themselves, will not provide answers to all the scientific and technological questions that we face on the road to practical fusion energy. (Summaries of the missions, capabilities and plans for major facilities and research projects in the international program are detailed in chapter 3.)

While the charge asks for priorities, it does not ask for a review of the entire program. In particular, it does not ask us to assess the research program necessary to make ITER and U.S. participation in ITER a success, though it is clear that this is the top priority of the U.S. program. (A committee of the Burning Plasma Organization is actively pursuing this topic.) Other elements of the program are excluded by construction, for example inertial confinement and alternate magnetic concepts are considered only to the extent that they could influence or facilitate, in a significant way, the direct path from ITER to Demo. We note that the charge anticipated additional planning activities that would cover parts of the program not within the scope of this one. The panel carried out its prioritization in this context and readers should not assume that any comparative judgments have been made between the activities covered in this report and those excluded.

The charge does not request a new fusion roadmap or development plan. Where needed, the panel assumed the program development pace to be given roughly by the FESAC fusion development plan [1.1], modified by the delays in ITER approval and the start of construction. This ambitious schedule leads to an emphasis on the most developed approaches, mainly involving the tokamak and its advanced and low-aspect ratio variants. Stellarator issues were also reviewed, as it is the next most developed concept and operates intrinsically steady-state and without disruptions – two critical issues for the tokamak. Other magnetic configurations were discussed in so far as they have potential for contributing to the main-line path, but under the assumptions of the charge, their principle role would be to mitigate technical risk and provide possible improvements for the next generation of fusion plants. While our attention was concentrated on more or less conventional approaches, the panel was mindful that the program must be open to opportunities for breakthroughs, for example in new concepts, materials or magnets, which have the potential to change the landscape for fusion.

The charge was oriented toward “major” activities. In addition to possible new facilities, the panel was asked to examine large-scale computational initiatives or other large coherent programs that would be needed to answer critical questions. The panel restricted its attention to general missions, facility concepts and approaches and did not review specific machine designs or proposals, neither were budgets explicitly considered.

### 1.c. Recent Planning Exercises and Reviews

The policy groundwork for the current direction of the U.S. program was set down in a series of workshops [1.2,1.3], studies and reports from the NRC[1.4] and FESAC[1.5,1.6] which all stressed the importance of burning-plasma research and recommended U.S. participation in ITER. Preparing for ITER operation and carrying out its research program will occupy a large part of the U.S. fusion community for several decades. In this context, the major U.S. facilities have been reviewed [1.7] and found to have a solid record of achievement, a strong foundation for our involvement in ITER and, given the diminished budgets, a surprising level of leadership in many important areas. A comprehensive assessment of scientific questions challenges laid out the technical priorities and identified opportunities for future progress [1.8]. Most recently, an NRC decadal study of plasma science heralded a “new era in magnetic fusion research”, built on the start of ITER, and challenged the fusion program to begin long-term planning in that circumstance [1.9]. It posed two questions for this exercise, the first concerned preparation for the ITER research program and the second asked “What science and enabling technology must be developed to move beyond ITER to fusion-generated electricity?”. This is precisely the question that the panel has attempted to address in this report. In our own deliberations, we have been able to build on the solid foundation provided by all of the previous studies noted here.

### 1.d Discussion of Demo and Characteristics

To answer the charge, the panel needed a working definition for Demo and an outline of its characteristics. Given the time span, it was not possible or reasonable to try to predict precisely how Demo would be implemented, thus we chose to use a broad definition to ensure that the program does not foreclose options prematurely. In U.S. planning, Demo is the last step before commercialization of fusion energy. Demo must provide power producers with the confidence to invest in commercial fusion power plants, *i.e.*, demonstrate that fusion is practical, reliable, economically competitive, and meets public acceptance. In addition, Demo must operate reliably and safely on the power grid for long periods of times (*i.e.*, years) so that power producers gain operational experience. (Further details on the U.S. vision for Demo and a comparison with the plans of our ITER partners can be found in section 3.e of this report.)

The top level goals for the U.S. Demo were summarized in the FESAC fusion development plan [1.1]:

#### Integration and Scalability to a Commercial Power Plant:

1. Use the physics and technology anticipated for the first generation of commercial power plants as an integrated system
2. Be of sufficient size for confident scalability (>50%-75% of commercial).

#### Reliability

3. Demonstrate robotic or remote maintenance of fusion core.
4. Demonstrate routine operation with minimum number of unscheduled

## Draft FESAC sub-panel report – Do not circulate

shutdowns per year.

5. Ultimately achieve an availability  $> 50\%$  and extrapolate to commercially desired levels.

Safety and Environmental Impact:

6. Not require an evacuation plan.
7. Generate only low-level waste.
8. Not disturb the public's day-to-day activities.
9. Not expose workers to a higher risk than other power plants.
10. Demonstrate a closed tritium fuel cycle.

Economics:

11. Demonstrate that the cost of electricity from a commercial fusion power plant will likely be competitive.

The panel noted that this definition of Demo is different than that used by some other fusion programs in the world. In particular, the requirement that a U.S. Demo use and demonstrate the same technologies that will be incorporated in a commercial power plant is fundamental for enabling private investment. If the basic technologies are improved following the Demo, they may require demonstration in a new Demo to reduce risk before incorporation in a commercial plant. The differences between the U.S. and other international fusion programs approach to Demo are discussed in Chapter 3.

### **1.e Approach Taken By Panel And Organization Of Report**

The panel began by attempting to identify all the scientific and technical questions which confront magnetic fusion research. We then consolidated these under three major themes into a tractable set of high-level issues which would serve as the basis set for our prioritization and gap analysis. We recognized that our particular organization of the issues is not unique, but it was designed especially to be useful for the rest of our activities. Chapter 2 carefully and concretely defines each issue, the extrapolations in knowledge that each required and the important couplings between issues. This provided the common understanding for prioritization, which was carried out, in the first place, using a well-defined set of criteria and scoring system. Further discussion was needed to resolve discrepancies in scoring and to reach consensus. The inventory of “available means” was straightforward. Chapter 3 presents an inventory of “available means” to address these issues. It summarizes the mission, capabilities, schedule and plans for each major facility as well as large computational initiatives, technology programs, and test stands. For further perspective, it surveys the international plans for fusion development. As far as possible we have relied on original sources. Using this background, the anticipated gaps in our knowledge are analyzed in Chapter 4, including a compilation of fine-scale gaps and activities or “mission-elements” which could fill the gaps. The gaps were then combined into a smaller set of “significant” or major gaps and the mission elements consolidated into a list of possible major initiatives facilities and programs in chapter 5. The relationship between the gaps and initiatives is shown graphically in figure 1. This provides, in effect, a menu from which a set of activities which would fill all gaps could be chosen..



## Draft FESAC sub-panel report – Do not circulate

### References

- [1.1] FESAC – Fusion Development Path 2003  
[http://www.ofes.fusion.doe.gov/More\\_HTML/FESAC/DevReport.pdf](http://www.ofes.fusion.doe.gov/More_HTML/FESAC/DevReport.pdf)
- [1.2] Final report from Snowmass workshop, 2002:  
[http://fire.pppl.gov/snowmass02\\_report.pdf](http://fire.pppl.gov/snowmass02_report.pdf)
- [1.3] Final report from Snowmass workshop, 1999:  
<http://www.ap.columbia.edu/SMproceedings/>
- [1.4] NRC – Burning Plasmas 2003  
[https://burningplasma.org/ref/fp/nrc\\_bpac\\_draft\\_prepub.pdf](https://burningplasma.org/ref/fp/nrc_bpac_draft_prepub.pdf)
- [1.5] FESAC – Burning Plasma Program Strategy (Snowmass 2002 follow-up)  
[http://www.ofes.fusion.doe.gov/More\\_HTML/FESAC/Austinfinalfull.pdf](http://www.ofes.fusion.doe.gov/More_HTML/FESAC/Austinfinalfull.pdf)
- [1.6] FESAC – Review of Burning Plasma Physics 2001  
[http://www.ofes.fusion.doe.gov/More\\_HTML/FESAC/BurningPlasma8-2001.pdf](http://www.ofes.fusion.doe.gov/More_HTML/FESAC/BurningPlasma8-2001.pdf)
- [1.7] FESAC – Review of Major Facilities 2005  
[http://www.ofes.fusion.doe.gov/more\\_html/FESAC/Facilities-Volume1\\_august\\_2005.doc](http://www.ofes.fusion.doe.gov/more_html/FESAC/Facilities-Volume1_august_2005.doc)  
[http://www.ofes.fusion.doe.gov/more\\_html/FESAC/FacilitiesVolume2\\_v3.pdf](http://www.ofes.fusion.doe.gov/more_html/FESAC/FacilitiesVolume2_v3.pdf)
- [1.8] “Scientific Challenges, Opportunities and Priorities for the U.S. Fusion Energy Science Program”, FESAC Report, 2004  
[http://www.ofes.fusion.doe.gov/more\\_html/FESAC/PP\\_Rpt\\_Apr05R.pdf](http://www.ofes.fusion.doe.gov/more_html/FESAC/PP_Rpt_Apr05R.pdf)
- [1.9] NRC decadal study of plasma science 2007
- [1.10] “Non-Electric Applications of Fusion, FESAC Report, 2003  
[http://www.ofes.fusion.doe.gov/More\\_HTML/FESAC/FESACFinalNon-Elec.pdf](http://www.ofes.fusion.doe.gov/More_HTML/FESAC/FESACFinalNon-Elec.pdf)



## Chapter 2 Scientific and Technical Questions on the Road Toward Demo

### 2.a. Themes and Issues

Charge 1 requires that we identify the scientific and technical questions which must be answered before we are ready to proceed to Demo. Together, these questions should define the challenges ahead and set the long-term research agenda for the U.S.

The panel also recognized a set of overarching issues, which were entwined with most of the others and which, in many cases, explicitly or implicitly drive research in other areas. These issues describe necessary characteristics of an overall fusion system and include availability, maintainability, reliability, economics and safety. The panel debated about the treatment of these issues and decided, with the exception of safety, that they were best thought of as aspects of the other issues and that treating them separately would diminish their importance and impact. (It was felt that there were features of the safety and environment issues that were sufficiently separable which warranted somewhat different treatment.)

It was useful to organize the issues into three broad themes, which provided a narrative framework into which specific issues fit and which helped to clarify the relationship between issues. These themes have some commonality with those used by the FESAC priorities panel but are not identical due to different emphases in the charges. The themes were defined in terms of the knowledge that will need to be accumulated prior to Demo and the use to which that knowledge would be put. In the definitions, we emphasize that the knowledge gained must be based on sound scientific principles and rigorously tested in the laboratory so that the step to a demonstration power reactor would be taken with high confidence of success.

Theme A. Creating predictable high-performance steady-state plasmas

*The state of knowledge must be sufficient for the construction, with high confidence, of a device that permits the creation of sustained plasmas which meet simultaneously, all the conditions required for practical production of fusion energy.*

Theme B. Taming the Plasma Material Interface

*The state of knowledge must be sufficient to design and build, with high confidence, robust material components which interface the hot plasma in the presence of very high neutron fluences.*

## Draft FESAC sub-panel report – Do not circulate

### Theme C. Harnessing fusion power

*The state of knowledge must be sufficient to design and build, with high confidence, robust and reliable systems which can convert fusion products to useful forms of energy in a reactor environment, including a self-sufficient supply of tritium fuel.*

Identification of the issues began by compilation of a long list of outstanding questions organized topically. After considerable discussion, these were consolidated into a shorter list, at appropriate granularity, which could provide the basis set needed for prioritization and gap analysis. This decomposition and organization of issues is clearly not unique, but was designed to aid in answering subsequent parts of the charge. Concrete definitions and detailed descriptions were written for each issue. This was crucial, since the precise boundaries between related issues has a marked impact on the assessment of priorities. Extrapolations from the current state of knowledge and device performance to the level required for Demo were also identified. The detailed descriptions are included in section 2.b. below. The issues, sorted under their thematic headings are:

### Theme A. Creating predictable high-performance steady-state plasmas

1. Measurement: *Make advances in sensor hardware, procedures and algorithms for measurements of all necessary plasma quantities with sufficient coverage and accuracy needed for the scientific mission, especially plasma control.*
2. Integration of high-performance, steady-state, burning plasmas: *Create and conduct research, on a routine basis, of high performance core, edge and SOL plasmas in steady-state with the combined performance characteristics required for Demo.*
3. Validated Predictive Modeling: *Through developments in theory and modeling and careful comparison with experiments, develop a set of computational models which are capable of predicting all important plasma behavior in the regimes and geometries relevant for practical fusion energy.*
4. Control: *Investigate and establish schemes for maintaining high-performance, burning plasmas at a desired, multivariate operating point with a specified accuracy for long periods without disruption or other major excursions. (Provision for sensors is included under issue 1 and for actuators under issue 6.)*
5. Off-normal Plasma Events: *Understand the underlying physics and control of high-performance magnetically confined plasmas sufficiently so that 'off-normal' plasma operation, which could cause catastrophic failure of internal components, can be avoided with high reliability and/or develop approaches that allow the devices tolerate some number or frequency of these events. (Because of their implications and importance, these 'off normal events' are called out separately from the control issues listed above).*

## Draft FESAC sub-panel report – Do not circulate

6. Plasma Modification by Auxiliary Systems: *Establish the physics and engineering science of auxiliary systems which can provide power, particles, current and rotation at the appropriate locations in the plasma at the appropriate intensity.*

7. Magnets: *Understand the engineering and materials science needed to provide economic, robust, reliable, maintainable magnets for plasma confinement, stability and control.*

### B. Taming the plasma material interface

8. Plasma-Wall Interactions: *Understand and control of all processes which couple the plasma and nearby materials.*

9. Plasma Facing Components: *Understand the materials and processes that can be used to design replaceable components which can survive the enormous heat, plasma and neutron fluxes without degrading the performance of the plasma or compromising the fuel cycle.*

10. RF Antennas, Launching Structures and Other Internal Components: *Establish the necessary understanding of plasma interactions, neutron loading and materials to allow design of RF antennas and launchers, control coils, final optics and any other diagnostic equipment which can survive and function within the plasma vessel.*

### C. Harnessing fusion power

11. Fusion Fuel Cycle: *Learn and test how to manage the flow of tritium throughout the entire plant, including breeding and recovery.*

12. Power Extraction: *Understand how to extract fusion power at temperatures sufficiently high for efficient production of electricity or hydrogen.*

13. Materials Science in the Fusion Environment: *Understand the basic materials science for fusion breeding blankets, structural components, plasma diagnostics and heating components in high neutron fluence areas.*

14. Safety: *Demonstrate the safety and environmental potential of fusion power: to preclude the technical need for a public evacuation plan, and to minimize the environmental burdens of radioactive waste, mixed waste, or chemically toxic waste for future generations.*

## 2.b. Detailed Discussion of the Issues

**2.b.1. Measurement:** *Make advances in sensor hardware, procedures and algorithms for measurements of all necessary plasma quantities with sufficient coverage and accuracy needed for the scientific mission, especially plasma control.*

Measurement capability is essential to the development of plasma science and fusion power. Progress toward the development of predictive physical models and validated computer simulations is paced by deployment of innovative plasma diagnostics. The ability to measure quantities that characterize the plasma-material interface is also required to help specify material properties able to withstand a fusion environment. The long term control and stability of fusion plasmas depends on robust diagnostics that provide a continuous stream of reliable and detailed information. Although measurement capability is mature for existing experimental facilities, significant gaps remain in the coverage of desired measurements and in the development of measurement capability within a nuclear burning plasma environment. Four sub-issues describing measurement capability are described below.

a. Diagnostic Capability (adequacy of measurements for achieving predictive understanding and plasma control)

The understanding of fusion plasmas is advancing rapidly, building on improvements in theory, applied math and powerful codes, combined with the development of diagnostics able to measure a wide range of plasma quantities. A significant portion of effort and funding, at every magnetic confinement facility, is devoted to the development and deployment of diagnostics. Some measurements remain extremely difficult and relatively rare, yet vital to the development of predictive fusion science. Perhaps most notable in this category are detailed measurements of plasma fluctuations in the frequency and wavelength range important for turbulent transport.

The science of plasma control has also advanced greatly. Many of the high performance configurations that would maximize the attractiveness of a fusion power source have stringent requirements on quantities such as the plasma shape and profiles for the plasma pressure and current. Controlling such plasmas in steady-state, including avoidance and mitigation of off-normal transients, is increasing important. The quantities that need to be measured are mostly known, and future development needs focus more on providing a robust, high quality data stream to interface with actuators that directly influence plasma quantities.

Extrapolation: A reasonable understanding of the desired measurements is already in hand. The existing and planned low-neutron facilities are or will be substantially diagnosed. Measurements that directly identify turbulent transport mechanisms are notably rare and challenging; most measure density fluctuations only while measurements of other fluctuating fields, such ion or electron temperature and potential would be invaluable in making comparison with theory. Many established diagnostic techniques will not work in a burning plasma (nuclear) environment. Hence substantial

## Draft FESAC sub-panel report – Do not circulate

development of diagnostics suitable for a Demo environment must ensue, as described below.

### b. Diagnostic compatibility in nuclear environment

Many of the diagnostics presently employed will be unavailable or much more difficult in Demo. These issues are already exposed in the diagnostics planned for ITER. For example, ITER (and Demo) will not have neutral beams that penetrate deeply into the plasma. Measurements that are enabled by beam-plasma interactions will therefore be limited or unavailable. If new techniques are not developed to provide equivalent measurements, the advanced tokamak program on ITER could be seriously hampered by lack of vital pressure and current profile information. This could limit the ability to control the plasma in advanced, high performance modes of operation.

These issues are accentuated in Demo. Generally it is believed there will be less access to the plasma, while at the same time control of profiles, monitoring of material erosion, accounting for tritium inventory, etc. will be essential. The neutron fluence in Demo will be several-fold larger than in ITER, restricting material choices for nearby diagnostics components. Like many other components, diagnostics will need to be remotely maintainable. The robustness of the measurements will need to be greater than presently achieved in order to maintain plasma control over long periods of time.

Extrapolation: Many existing diagnostic techniques are not compatible with an intense nuclear environment. The neutron fluence will be much larger in Demo than ITER. The ITER diagnostic set is currently not adequate for the plasma control envisioned in advanced tokamak regimes. New diagnostics will be required for the plasma-boundary interface, and for monitoring tritium inventory.

### c. In situ, long term calibration and testing

The continuous operation of Demo demands a degree of measurement robustness that has not been required to date. Not only does the data need to be continually reliable, but a gradual change in the instrumentation physical characteristics from neutron and radiation damage must be accounted for. At the same time, the near steady-state operation of the device will limit access to diagnostic hardware and its ability to operate during diagnostic maintenance.

Extrapolation: There is limited experience in this area (it has not been a major issue so far). Accounting for continual damage and degradation of optical and electrical components will be essential. New calibration and testing approaches will be needed that do not rely on substantial “off-line” access, both in the amount of time available and in hands-on accessibility (remote maintenance required).

### d. Interpretation and analysis

## Draft FESAC sub-panel report – Do not circulate

Many plasma diagnostics are easy to interpret, while others required sophisticated analysis to glean important measurement information. The fusion community includes many experts in data analysis. Looking to the future, the main challenge will be providing this information in real-time with high reliability. This may be more a technical issue as opposed to a conceptual issue.

Coupling measurements more closely to validated predictive fusion science might enable a reduction in diagnostic coverage and analysis requirements. This is important given the likelihood for reduced diagnostic access in Demo.

Extrapolation: There is a great deal of established experience and expertise for data interpretation and analysis in the fusion program. Future requirements will stress steady-state, real-time analysis for control with an extremely high degree of reliability. There may be a need for more sophisticated modeling as a part of measurement analysis, particularly if diagnostic access is more limited in ITER and Demo.

### Associated coupling and integration issues:

- measurement requirements for validation of predictive fusion science
- measurement requirements for robust, long-term plasma control, including off-normal transients
- monitoring the plasma boundary interface, including materials
- compatibility with remote handling and maintenance
- requirements for safe operation of a fusion reactor

**2.b.2. Integration of high-performance, steady-state, burning plasmas:** *Create and conduct research, on a routine basis, of high performance core, edge and SOL plasmas in steady-state with the combined performance characteristics required for Demo.*

An essential challenge for Demo is to successfully manage the complex integration of all the fundamental physics elements of fusion so that a stable, steadily burning plasma state is achieved. The burning plasma core is replete with complex internal feedback loops and non-linear couplings. The dominant (>80%) internal source of heat in the plasma will be from alpha particles produced in the fusion reactions, and the magnitude and spatial distribution of that heat source will depend on the magnitude and spatial distribution of the plasma pressure. But the pressure distribution itself is determined by the dominant alpha particle heat source and external sources of heat and particles and the spatial profiles of the plasma transport. The plasma transport is determined largely by plasma turbulence which is in turn determined by the gradients of the plasma temperature and density, and is also profoundly affected by the spatial distributions of magnetic and electric fields. The energetic alpha particles may promote or deteriorate the stability of the plasma, perhaps causing loss of the alpha particles and their vital heating effect. An efficient Demo plasma needs to operate at high pressures to ensure adequate fusion power, and to sustain this power level at very high availability and preferably steady-state for attractive economics. In addition, this complex burning plasma core must be coupled to the edge and SOL plasma to exhaust plasma energy and particles at manageable power



densities under steady-state conditions while maintaining efficient confinement and sustainment of the plasma core.

The integration of high performance, steady-state burning plasmas can be divided into four elements;

- a. High performance burning plasma core,
- b. Edge and scrape-off plasmas, and
- c. Sustainment of magnetic configuration and plasma.
- d. Optimization of the plasma configuration

a. High Performance Burning Plasma Core

**Fusion Gain** – A fusion power plant plasma, and hence Demo, will require a fusion power gain ( $Q = P_{\text{fusion}}/P_{\text{ext-heat}}$ ) in the range of  $Q = 25 - 50$  to provide net electricity at competitive prices. [2.b.2.1, 2.b.2.2]. At these fusion gains, the plasma is 83 –91% self-heated. The physical requirements for the achievement of high gain, developed by Lawson [2.b.2.3] in 1957 are summarized for a typical magnetically confined plasma in the Lawson Diagram [Fig 2.b.2]. High fusion gain in a 50/50 DT plasma requires a fusion fuel density ( $n_e$ ) times energy confinement time ( $\tau_E$ ) product of  $\approx 6 \times 10^{20} \text{ m}^{-3} \text{ s}$  at a fuel temperature in the 10-20 keV range. The primary challenge has been to obtain the required temperature, density and confinement simultaneously in an integrated manner.

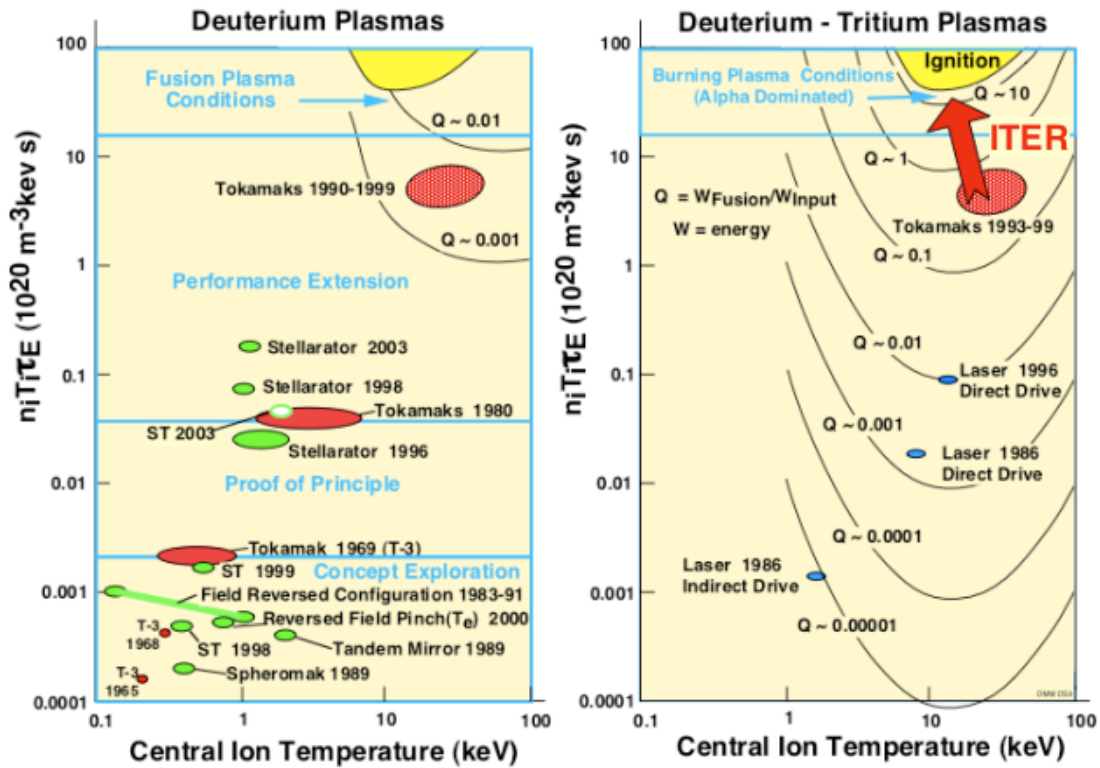

Fig. 2.b.2 Lawson Diagram for Magnetic Fusion

## Draft FESAC sub-panel report – Do not circulate

Plasma Confinement - A crucial issue in designing a device to attain high fusion gain is the uncertainty in predicting plasma energy and particle confinement. In the past, the primary method of predicting confinement was to use empirical scaling relations determined from extensive data bases of experimental results from many experiments. A significant effort has been underway to develop more accurate physics based models of plasma energy and particle transport, and to then test these models under conditions relevant to Demo plasmas. Extrapolation of plasma confinement should be more straightforward from plasmas whose dimensionless parameters ( $\omega_c \tau_E = B \tau_E$ ,  $\rho^* = \rho_i/a$ ,  $v^* = R/\lambda$ ,  $\beta$ ,  $T_i/T_e$ ,  $V_{rot}/V_{Alfvén}$ ,  $a/R$ ,  $\kappa$ ,  $q$ ) are similar to those expected in a Demo plasma. The overall similarity parameter,  $BR^{5/4}$ , of ITER and Demo are approximately the same, so ITER will have the capability to access plasma physics regimes very close to those of a Demo plasma.

Fusion Power Density – In addition to high fusion gain, the burning plasma core must produce a sufficient fusion power density to achieve economic attractiveness. For D-T plasma temperatures in the range of 10-20 keV, fusion power density is proportional to  $p^2$ , where  $p$  is the plasma pressure. The plasma pressure is constrained by MHD stability limits,  $\beta = \langle p \rangle / B_0^2 < \beta_{limit} = \beta_N I / a B_0$  where  $B_0$  is the magnetic field in the center of the plasma chamber. MHD stability limits can be increased by the use of conducting walls surrounding the plasma or by feedback stabilization of modes. Typically,  $\beta_N < 3$  can be achieved without conducting walls, full exploitation of advanced tokamak modes with  $\beta_N \sim 5$  will require feedback stabilization. The magnetic field in the plasma is limited by stresses and current density limits produced by the magnetic fields ( $B_c$ ) at the coil, and by the geometric configuration of the magnetic coil. The maximum fusion power density is therefore  $p^2 \sim [\beta_N (I/a B_0)]^2 (B_0/B_{coil})^4 B_{coil}^2$ . In a Demo design, the required fusion power density can be obtained by a tradeoff between the physics challenges of high  $\beta$ , the engineering challenges of high  $B_{coil}$ , and optimization of the coil geometry, ( $B_0/B_{coil}$ ).

Consequences of Plasma Instability and Magnetic Asymmetries (see section 2.b.5) - When the operational stability limits are violated large scale instabilities can occur with a range of consequences. Most of these instabilities serve to reduce plasma confinement thereby degrading the fusion power output. However, the most virulent instabilities such as the major disruption, can produce significant transient heat loads and electromagnetic loads on internal components. While existing devices have developed designs and operational techniques to mitigate and survive the effects of disruptions, the consequences will increase for ITER and Demo. The presence of large repetitive edge localized modes (ELMs) can also cause extensive melting and erosion of divertor components. Metrics include:  $\delta W_{th}$ ,  $\tau_{dur}$ ,  $I_{halo}$ , scaling of thermal and EM loads with size, and disruption frequency)

The loss of a small fraction of the energetic alpha population due to instabilities or magnetic field asymmetries can produce severe localized heat loads and the possibility of localized damage to internal components. This has been observed in present experiments and techniques have been developed to eliminate the source and mitigate the effects. The losses due to field asymmetries are relatively well understood and can be predicted if the field asymmetries are known. A new issue will be the magnetic asymmetries introduced

## Draft FESAC sub-panel report – Do not circulate

by the ferromagnetic materials being proposed for the first wall and breeding blankets in a Demo or power plant. This issue will be addressed using non-burning plasmas in JT-60SA and by test blanket modules in ITER. Metric: allowed  $P_\alpha$  loss (MW,  $\text{MWm}^{-2}$ , % of  $P_\alpha$ )

### b. Edge and Scrape-off Plasmas

The edge and scrape-off plasma provides the interface between the high temperature of the fusion plasma core and material walls of the vacuum chamber while exhausting the plasma energy and particles (especially alpha ash) at high power densities under steady-state conditions. The plasma edge is required to provide a high temperature ( $\sim 4$  keV) boundary condition for the plasma core that allows the plasma core to maintain adequate plasma confinement and low plasma densities to increase core current drive efficiency. The outer edge of the plasma scrape-off interacts with the first wall and divertor material and is desired to have higher density to help reduce the temperature to  $\sim 20$  eV to reduce material erosion to allowable levels. Materials erosion and re-deposition must also be compatible with low tritium retention. The edge plasma has the additional complications of: significant plasma flows, increased levels of impurities, alpha ash and neutrals, significant radiation losses and complicated geometry. In addition, Edge Localized Modes (ELMS) periodically collapse the edge transport barrier injecting large fluxes of energy into the scrape-off plasma. The parameters of interest in understanding the edge plasma include:  $T$ ,  $n_e$ ,  $v_{//}$ ,  $Z_{\text{eff}}$ ,  $q_{//}$ ,  $P_{\text{loss}}/A_{\text{div}}$  ( $\text{MWm}^{-2}$ ).

### c. Sustainment of the Magnetic Configuration and Burning Plasma.

Studies of magnetic fusion power plants indicate the need to operate with high availability over periods of  $\sim 1$  year. Steady-state operation is highly desirable with an approximately factor of two reduction in estimated cost of electricity for steady-state operation relative to pulsed operation (as in an inductively driven tokamak). The goal is to have the capability of continuous operation for periods of  $\approx 1$  year.

Magnetic Configuration Sustainment - Tokamak: The magnetic configuration of a tokamak relies on a large toroidal plasma current which is sustained by an inductive electric field for durations of minutes in present experiments. The toroidal current can also be driven for longer periods of time by the injection of radio frequency (RF) waves or neutral beams (NB). The physics of RF and NB current drive is relatively well understood, and has been verified in several experiments. Tokamak plasmas have been sustained for  $> 5$  hours using RF waves. In addition, a substantial fraction ( $\sim 80\%$ ) of the toroidal current can be produced by pressure gradients within the plasma by the “bootstrap” current effect which has been demonstrated for short durations on existing experiments. A range of continuous operation power plant designs have been analyzed with bootstrap fractions ranging from 60% to 90% with the remainder driven by RF waves and NB. The economic benefit rises over this range. The major issues are the cost required to construct and operate a reactor-relevant current drive system, and the robustness of high gain burning plasmas to provide a large fraction of the plasma current in the presence of the strong coupling among alpha heating defined plasma pressure

## Draft FESAC sub-panel report – Do not circulate

profiles, MHD stability and plasma transport.

Magnetic Configuration Sustainment - Stellarator: The magnetic configuration of a stellarator is inherently steady-state and is produced primarily by three dimensional magnetic coils, with internal “bootstrap-like” plasma currents providing additional magnetic transform. Generally, stellarators do not suffer from disruptions and ELMS are not observed at high- $\beta$ . Stellarators optimized for low plasma currents such as W-7X lead to very large fusion power plants [2.b.2.4]. Recent theoretical studies indicate that “quasi-symmetric” stellarator (QAS) configurations [2.b.2.5] exist with desirable properties. A QAS design can be optimized for equilibrium, MHD stability, energetic particle confinement, etc. at a lower aspect ratio  $R/a_{\min}$  than the standard stellarator with an increased bootstrap plasma current that produces up  $\sim 25\%$  of the transform. Such a configuration has been analyzed in the Aries-CS study potentially produce an attractive reactor. The higher density limit in stellarators is advantageous for reducing alpha-particle driven instabilities and reducing edge temperatures for interfacing with the PFCs. The issues for the stellarator are general validation of the QAS principal, closure of flux surfaces, energetic particle confinement in non-symmetric geometry, uncertain  $\beta$  limits, power and particle removal in 3-D geometry and the complexity and cost of the three dimensional structure. Experiments are required to confirm that these Issues can be achieved simultaneously, and to develop the understanding of how to optimize future 3D configuration designs.

Plasma Sustainment: The fuel mix in a burning plasma must be sustained by continual refueling of the plasma core through a combination of external fuel injection (e.g., gas or pellet injection) penetrating past the plasma SOL followed by internal processes that transport fuel into the central core region. While fuel is being transported inward, alpha ash must be removed from the fusion core and impurities originating from the PFCs must be prevented from migrating to the plasma core. Finally, the SOL must transport alpha ash, impurities and spent DT fuel into the divertor pumping system for separation and re-injection of the DT fuel.

Key parameters for the fueling, ash removal and impurity control processes are line density ( $n_a$ ), plasma temperature and profile shapes. Particle transport processes are not well understood on existing tokamaks, but satisfactory techniques have been developed that are effective on plasmas with large  $n_a$  such as JET and C-Mod. ITER will provide a major test and demonstration of particle control techniques since it is the roughly the same line density and temperature as a Demo plasma.

Plasma Facing Component Sustainment: The plasma facing components must be have erosion lifetimes compatible with continuous operation at high power density in an intense neutron irradiation environment for up to one year. (Section 2.b.9)

### d. Optimization of the plasma configuration for Demo

The default choice for the first Demo has not changed significantly over the past 20 years, and is based on a tokamak with a standard aspect ratio and modest advanced capability

## Draft FESAC sub-panel report – Do not circulate

( $\beta_N = 3-4$ ,  $f_{bs} = 60-70\%$ ). Over the next decade, improved understanding of the physics phenomena and engineering capabilities gained from physical experiments and ever improving computer simulations will determine how much this default choice may be modified for the initiation of Demo design activities. A key on-going activity will be systems studies aimed at identifying the high leverage technical areas and characteristics of interest to the eventual customer.

Strongly Self-Heated Plasma Coupling Issues: The degree to which a strongly self-heated plasma creates a robust operating range with the desired properties is an over arching issue for magnetic fusion. The strong self-heating removes our ability to control the plasma with external sources, and allows the internal couplings to define the plasma state. The associated coupling and integration issues are:

- High performance with sustained/sustainable configurations
  - Self-consistent, self-heating at high Q, pressure profile
  - Self-generated current consistent with self-heating
  - Burn control (thermal stability)
  - Control with Demo relevant measurements
  - Ultra-Low disruptivity
- High-performance sustained core plasma with FW/Divertor
  - Fueling, impurity control and ash removal consistent with high-performance sustained core
  - Edge densities and temperatures consistent with efficient current drive and reliable divertor operation
  - Heating and current drive systems consistent with core and edge conditions required for Demo
  - Sustainable transient heat loads– ELMs, disruptions, etc at high performance.

### References

- [2.b.2.1] The ARIES Reports are at <http://aries.ucsd.edu/ARIES/DOCS/bib.shtml>
- [2.b.2.2] [http://www.efda.org/downloads\\_divers/ppcs.pdf](http://www.efda.org/downloads_divers/ppcs.pdf)
- [2.b.2.3] J. D. Lawson, Proc. Phys. Soc. B, V 70, p 6, (1957).]
- [2.b.2.4] H. Wobig and F. Wagner, Magnetic confinement fusion: stellarator, Energy Technologies. Subvolume B: Nuclear Energy, Vol 3, 418-452, 2005
- [2.b.2.5] S. P. Hirshman et al, Phys. Plasmas **6**, 1858 (1999); A. Reiman et al, Plasma Physics Contr. Fusion **41**, B273 (1999); D. A. Spong et al., Nucl. Fusion **45**, 918 (2005).

**2.b.3. Validated Predictive Modeling:** *Through developments in theory and modeling and careful comparison with experiments, develop a set of computational models which are capable of predicting all important plasma behavior in the regimes and geometries relevant for practical fusion energy.*

The ITER design is based primarily on extrapolation from existing experiments. Some of these extrapolations are not large and are well-guided by theoretical ideas. In many important cases, however, the extrapolations are large and no clearly validated and

## Draft FESAC sub-panel report – Do not circulate

widely accepted theoretical ideas exist to inform mission-critical design decisions. In the face of this uncertainty, the cost of the ITER project is higher than it otherwise would have been, and its success cannot be assumed to follow without further significant investment. Even assuming success in meeting specific operational targets over the lifetime of the experiment, significant extrapolations from ITER to DEMO will remain. How will the DEMO plasma behave? What are the critical design elements that will allow the DEMO operators to get the plasma performance required for safe, reliable operation? Without validated, predictive models of plasma behavior, these questions will not be answerable, and the cost and risks of DEMO will be higher than necessary.

Successful operation of the ITER burning plasma experiment depends on continuing to improve our understanding and predictive capability. However, further progress in four critical areas (turbulence/transport, magnetohydrodynamic physics, boundary physics and wave-particle interactions) will not be possible with a significant expansion of plasma diagnostic capabilities. We cannot understand what we cannot measure. The nuclear and high heat flux environments of ITER (and more so, DEMO) mean that diagnostic information will be especially expensive. We will be forced to measure less of the fantastically large range of spatio-temporal processes that comprise “plasma behavior”, not more. It is vitally important, therefore, that we develop clearer ideas about what must be measured and understood in ITER to design DEMO. In light of tremendous strides in theoretical modeling that have been taken over the last decade or so, the least expensive and highest value investment that can be made today to address DEMO plasma performance issues is in the area of validating emerging theoretical models of all important aspects of plasma behavior.

Model validation is the process through which the scientific community comes to accept that a particular model reliably predicts important aspects of plasma behavior. Hence, the development of validated predictive models will require active collaboration between the experimental, theoretical and computational communities. This effort will be the major mission of the “base program” through the completion of ITER operations as new experimental data leads to the refinement (or even abandonment) of theoretical models. New or refined theoretical models generally must be implemented in large computer codes if they are to capture the complexity of actual experiments. Testing the predictions of these models against experiments will require new diagnostics and will generally lead to further refinements in the underlying model and/or the numerical implementation. This iterative process is at the heart of the scientific method. Important aspects of plasma behavior which must be mastered include:

Turbulence and Transport. Achieving high fusion gain requires minimizing the transport of energy across magnetic surfaces; while achieving steady-state in a high-performance plasma requires control of the density (particularly the impurity density) and rotation profiles. It is generally accepted within the magnetic fusion community that, in the vast majority of experimental discharges, the dominant cause of the transport of particles, momentum, and energy across magnetic surfaces is plasma microturbulence — small fluctuations in the plasma electric and magnetic fields which result from the growth and saturation of waves driven unstable by the expansion free-energy of the plasma. Plasma

## Draft FESAC sub-panel report – Do not circulate

micro-turbulence differs from macroscopic, or MHD turbulence in that it saturates at a low level. The growth and saturation of plasma microturbulence generally depends on the velocity distribution of the various plasma species (electrons, deuterium, tritium, etc.). This turbulence can be described by a combination of the gyrokinetic equation [Antonsen, 1980; Frieman, 1982], to describe the state of the plasma velocity distribution(s), and Maxwell's equations, to describe the self-consistent electric and magnetic fields.

Computer codes implementing the gyrokinetic/Maxwell model have been developed. These codes can be run on the current generation of supercomputers modeling time intervals which include many turbulence correlation times, thereby enabling detailed studies of plasma microturbulence as it exists in the computational models, and the validation of the gyrokinetic/Maxwell model through comparisons between detailed code predictions and experiment. This validation effort will require investment in experimental diagnostics to measure microturbulent fluctuations, experimental time on major tokamaks to make measurements over a wide range of plasma parameters, and continued development and maintenance of computer codes implementing the gyrokinetic/Maxwell system.

Turbulence correlation times are typically of the order of  $100 \mu\text{s}$  and these simulations, which may take weeks on modern supercomputers, model only a few milliseconds of a tokamak discharge. Confinement times (the time for the profiles of temperature, rotation, and density to change significantly) on ITER are expected to be several seconds (requiring simulations with a duration that is a thousand times longer) while the ITER discharge is expected to last 1000's of seconds (requiring simulations with a duration that a million times longer). These daunting computational requirements have motivated the development of reduced models for tracking the evolution of tokamak discharges over macroscopic time intervals. It is currently a matter of controversy whether such reduced models have retained enough of the physics governing plasma microturbulence to provide a reliable basis for predicting the transport of energy, momentum and particles in ITER and DEMO discharges. Generating a scientific consensus that such a reduced model will provide a reliable extrapolation from ITER to DEMO will require extensive collaborative effort on the part of experimental, theoretical and modeling groups.

Plasma Edge Turbulence The plasma edge includes open magnetic field lines, where the plasma impinges on material surfaces, together with an annulus of closed field lines enclosing the core plasma. Radial gradients in the temperature, rotation, and density are generally much larger in the plasma edge than in the plasma core. The transport of thermal energy across this region is important to the overall performance (and fusion gain) of the discharge; the flux of particles and energy from open field lines onto material surfaces is critical to the design of plasma facing components; and an important class of off-normal events, ELMs, originate in the plasma edge. A low frequency model like gyrokinetics is expected to describe fluctuations in the edge plasma. However, the steeper gradients can lead to substantially higher levels of turbulent fluctuations which challenge the gyrokinetic ordering; the presence of both open and closed magnetic surfaces complicates the geometry; and neutrals generated by the

## Draft FESAC sub-panel report – Do not circulate

recycling of plasma on material surfaces can provide important sources of particles and sinks for momentum and energy that are not included in current gyrokinetic codes. These complications are being addressed in a new generation of computer codes, currently under development, which are aimed at modeling plasma edge turbulence. Substantial investment will be required to complete the development of these codes and to validate them.

MHD. Magnetically confined plasmas are subject to spontaneous deformation. In extreme cases this results in the loss of confinement. The stability of the plasma against such deformations is described by magnetohydrodynamics (MHD). MHD is important to DEMO because the configurational instabilities described by MHD theory limit the plasma pressure and, hence, the fusion power density (which is proportional to the square of the plasma pressure). In addition, off-normal events, including disruptions and ELMs are described by MHD theory.

Computer codes implementing ideal MHD theory are well developed and accurately describe the onset and linear growth of configurational instabilities. Studies of the saturation and nonlinear consequences of such instabilities require the inclusion of finite plasma resistivity, viscosity, and other dissipative (non-ideal) effects. The plasma's motion is affected by the presence of conducting walls near the plasma. Computer codes have been developed which implement non-ideal MHD models. These codes have had success in modeling important plasma phenomena such as the “sawtooth crash”, plasma disruptions and ELMs. Further work is required to extend MHD theory to the long mean-free-path limit appropriate to fusion plasmas, including long mean free path and finite Larmor radius effects in computer codes that can also describe conventional MHD physics, and validating these models against experiment. Substantial opportunities exist to increase the plasma pressure limit using active feedback coils located outside the plasma, and this remains an active area of research. It is not currently clear which plasma properties should and can be measured in ITER and especially DEMO to provide the “sensors” for these feedback coils.

RF Wave Propagation and absorption. Radio frequency (RF) waves are used to heat plasmas to temperatures conducive to thermonuclear reactions ( $\sim 10^8$  °C) and to drive toroidal current and deposit momentum within the plasma. RF waves are envisioned as an important actuator for systems designed to control the operating point (particularly temperature, pressure, current, and rotation profiles) in burning plasmas. The theory of RF wave propagation within plasmas is well developed. However, large computer codes are required for the implementation of this theory to accurately address the geometric complexity of tokamaks, and the even greater geometric complexity of stellarators. In addition, the absorption of RF waves often results in substantial modification of the plasma distribution function which, in turn can substantially modify the absorption of the RF waves. Computer codes which address these have been developed and efforts to validate them against tokamak experiments have begun. A continuing effort on RF code development and validation will be required to address novel issues associated with burning plasmas, such as the presence of energetic alpha particles (produced by DT



fusion reactions), which can substantially modify RF wave absorption. Accurate models of the propagation of RF waves from the antenna through the edge plasma are required to reliably predict the antenna loading, that is the voltage required to launch a specified RF power into the plasma. Accurate estimates of antenna loading is critical to antenna design and remains an area of active research. Although open issues remain, RF wave propagation is a relatively mature field, and efforts have begun to couple RF modules into more comprehensive models of tokamak plasmas, investigating (for example) the effects of RF waves on MHD stability.

**2.b.4. Control:** *Investigate and establish schemes for maintaining a high-performance, burning plasmas at a desired, multivariate operating point with a specified accuracy for long periods without disruption or other major excursions. (Provision for sensors is included under issue 1 and for actuators under issue 6.)*

Plasma control by definition is crucial to controlled thermonuclear fusion. In particular, a magnetically confined burning plasma must be maintained for long periods - on the order of months. In control parlance, control actions are provided by actuators with the magnitude of the actuator response determined by sensors. The precise requirements for these actuators and sensors are described in sections **2.b.6** and **2.b.1**, respectively. For a burning plasma control loops will be required for the following areas.

### a. Plasma shape control

Plasma shape control is achieved by varying the currents in the poloidal field coils. Usually the plasma location is determined by magnetic diagnostics, although optical detection means have also been used successfully. The plasma boundary is well described by the ideal MHD equilibrium equation. There has been a long history of successful plasma shape control on a myriad of different experiments.

### b. Vertical position control

Although this topic is really a subset of shape control, it is usually treated separately because tokamaks, with highly elongated cross-sections, are unstable to vertical motion. The physics of this instability is well understood, and there is a large body of work aimed at developing sophisticated controllers in a tokamak. Remaining uncertainties arise from the difficulty in predicting the precise evolution of global parameters, such as the peakedness of the plasma current profile, that determine the growth rate of this mode.

### c. Current magnitude and profile control

Potential current drive actuators include neutral beam current drive, lower hybrid current drive, and electron cyclotron current drive with the bulk of the plasma current coming from the pressure driven currents. The plasma current profile can be measured by motional stark effect polarimetry, using neutral beams, or Faraday rotation. It is worth noting that the base plan of ITER does not address this issue.

## Draft FESAC sub-panel report – Do not circulate

### d. Plasma heating control

Plasma heating comes primarily from fusion generated alpha particles in a burning plasma, so the primary method of heating control will come from burn control. However a small additional plasma heating system could be used to help control the plasma pressure. ITER will address many of the plasma heating control issues, including burn control.

### e. Plasma fueling control and helium ash removal

The control of plasma fueling is an unsolved issue for Demo. Actuators for effective core fueling in plasma larger than ITER do not exist. If actuators could be developed, the principles of fueling control are straightforward, and measurements that scale to a larger device are available. It should be noted that the primary method for burn control in a burning plasma is fueling control. Therefore the issue of fueling control is crucial to ITER. The issue of plasma helium ash removal is one that ITER will address and will likely extrapolate to Demo.

### f. Divertor material temperature control

Control of the temperature in the divertor of Demo is an extremely challenging topic for which there is no clear solution. Effective strategies for controlling the power flux in the plasma divertor area need to be developed prior to Demo. Demo will have a much higher divertor heat load than ITER, so ITER cannot adequately address this issue.

### g. Disruption avoidance and mitigation

Frequent disruptions can not be tolerated in a Demo. The control of disruptions has not been achieved, and ITER will not be able to demonstrate the steady state avoidance of disruptions, due to its relatively short pulse length. Disruption mitigation is a field in its infancy, and it is not clear that any of the ideas currently being investigated scale to ITER, or to Demo. In addition, to date no reliable real time predictor of plasma disruptions has been demonstrated on an existing device. This is an important research activity for ITER and the accompanying tokamak program.

### h. Stability control

The topic of stability control includes the control of various instabilities such as ELMs, NTMs and RWMs. Each of these instabilities requires an independent controller and actuator loop. It is unclear to what extent ITER will address ELM and RWM control, although there is a high probability that ITER will address NTM control.

### i. Integrated control

## Draft FESAC sub-panel report – Do not circulate

The concept of integrated control implies developing a successful control strategy that encompasses all of the above control concepts along with the control of the understood aspects of plasma control (e.g. shape control, vertical stability control). It seems likely that if actuators and sensors for the unsolved control problems can be identified that an integration strategy could be created. However this has yet to be done.

**2.b.5. Off-normal Events:** *Understand the underlying physics and control of high-performance magnetically confined plasmas sufficiently so that ‘off-normal’ plasma operation, which could cause catastrophic failure of internal components, can be avoided with high reliability and/or develop approaches that allow the devices tolerate some number or frequency of these events. (Because of their implications and importance, these ‘off normal events’ are called out separately from the control issues listed above).*

Some undesirable events or modes affecting plasma confinement can seriously damage plasma-facing components (PFCs) and other structures. These “off-normal” plasma events include disruptions, run-away electrons, large edge localized modes (ELMS), and possibly bursts of energetic alphas ejected by processes involving energetic particle modes (EPMs) or Alfvén eigenmodes (AEs). The state of understanding of these events and their implications for ITER are described in Progress in the ITER Physics Basis, a special issue in Nuclear Fusion [2.b.5.1].

For this discussion, the term “off-normal” will refer to deviations from normal plasma operation that have proved challenging for the ITER design, and may not have design solutions for the higher-performance requirements of a Demo.

The PFCs for Demo must face more intense plasma and radiation environments, must have higher reliability and longevity, must allow self-sufficient tritium breeding, and must be consistent with higher coolant temperatures needed for efficient energy conversion to electricity. These requirements lead to designs that make them less able to withstand even the off-normal events expected in ITER. Unless radically new materials or designs for PFCs are discovered, the only solutions to this issue are to find methods to avoid or mitigate all off-normal plasma events in Demo, or to make such events exceedingly rare.

### a. Possible Approaches

Avoiding or mitigating off-normal plasma events in tokamaks is very challenging, particularly in the AT performance regime (high Q, high beta, high bootstrap fraction, steady state) anticipated for Demo. The issue appears to have only two possible plasma-based solutions:

1. Discover and develop improved techniques to predict and either avoid or mitigate off-normal events in an AT-regime tokamak with a high degree of confidence. A successful Demo design must provide for recovery from damage

## Draft FESAC sub-panel report – Do not circulate

caused by low-probability off-normal events within the availability, safety, and environmental constraints of an economically attractive electric power source.

2. Improve the understanding and performance of other confinement configurations that either avoid off-normal events or allow more confidence in their control. A successful non-tokamak Demo design must be based on demonstrated capability of steady-state, high-beta confinement and other properties consistent with providing the Q, availability (including recovery from any off-normal event), safety, and environmental features of an economically attractive electric power source. The stellarator is the most advanced configuration that has the potential to meet these requirements.

### b. Status and Extrapolation of Approach 1: AT-Regime Tokamak

The implications of the present understanding of four types of off-normal plasma events are summarized in this section. The focus will be on the most troubling aspects of these events, including the implications for ITER and the additional challenges for an AT-based Demo.

#### Disruptions

Research has focused on understanding various causes of disruptions and on many techniques for predicting, avoiding, and mitigating them [2.b.5.2]. The well-known operational limits on plasma current, electron density, and beta provide some guidance for reducing disruptions, but exceptions frequently occur that are not understood. Improved modeling and real-time analysis of diagnostic signals, including the use of neural networks have improved the ability to predict disruptions. For some types of disruptions the success rate on JT-60U was as high as 98%. However, the success rate for beta-limit disruptions is much lower. Reliable precursors have not been found for this type [2.b.5.3]. The lack of useful precursors poses a significant challenge for ITER exploring high-beta regimes, and is particularly troubling for an AT Demo.

Disruptions are considered inevitable in ITER as it will be used to explore a variety of operating modes. For this reason its PFCs are designed with extra armor that would not be allowed in Demo because of thermal transfer and breeding concerns. Nevertheless, disruptions are expected to shorten the useful lifetime of these components [2.b.5.4]. To minimize the impact of disruptions on ITER, strategies for predicting, avoiding, and mitigating them will continue to be studied on a variety of existing facilities, planned new large tokamaks, and on ITER. Avoidance and mitigation schemes include: avoiding the three limits mentioned above, soft-stop techniques, tearing mode stabilization by ECRH injection, vertical position control, and massive injection of impurities (killer pellet injection, massive gas injection, cooled liquid jets, etc.). However, these schemes do not help with high-beta disruptions that do not exhibit useful precursors.

Extrapolation. An AT-type Demo will require the discovery of a high-beta, steady-state (high-bootstrap-fraction) regime that is either disruption free, or exhibits useful

## Draft FESAC sub-panel report – Do not circulate

precursors. If precursors are discovered, the diagnostics for reliably detecting them must endure the nuclear fusion environment of Demo. The actuators for avoiding or mitigating the disruptions must also function in that high-Q plasma environment and must ensure that unmitigated disruptions are exceedingly rare. Moreover, the frequency and duration of mitigation events must be small enough so that cyclic fatigue does not unduly shorten the lifetime of PFCs and other components, and so that availability remains adequately high. These requirements for Demo exceed those needed for ITER, and meeting them will necessitate major advances in understanding and demonstrated performance.

### Runaway Electrons

The most likely cause for major runaway electron events is current conversion that can occur either during disruptions or during controlled fast-shutdowns (soft-stops) used to avoid disruptions. This close connection between runaways and disruptions motivates coupled research efforts. Conversion efficiencies of up to 70% of the plasma current into ~10MeV runaways are predicted in ITER. If the resulting 25 to 50 MJ is deposited in a small region of the first wall or divertor, major damage to the PFCs is expected [2.b.5.5]. The high electron energies imply deep penetration, which could result in damage down to the cooling channels, particularly in the thinner PFCs anticipated for Demo.

Two classes of mitigation strategies are being studied for ITER. One involves controlling an existing runaway discharge and slowly ramping it down over more than 10 s. The other uses massive injection of particles, by one of the previously listed techniques, to slow the runaways.

Extrapolation: The linkage between disruptions and runaways leads to the conclusion that avoiding disruptions in Demo should be sufficient to avoid runaway events. As described in the Disruption section, avoidance requires the discovery of a high-performance regime that is either disruption free or that exhibits useful precursors. All of the additional challenges described above apply. If soft-stops are used as a mitigation tool, then massive electron injection will also be needed to mitigate the resulting runaway events. These requirements for Demo exceed those needed for ITER, and they necessitate major advances in understanding and demonstrated performance.

### Large (Type I) ELMS

Large edge-localized modes (ELMs) are often found in plasmas with substantial pedestal pressure gradients and high confinement. Type I ELMS may be expected to dominate high confinement discharges in ITER and pose a significant challenge to PFCs in the divertor. Present empirical projections based on the low pedestal collisionality required for ITER indicate that the ELM energy will be 2 to 3 times greater than can be handled by the divertor. However there is substantial uncertainty in the detailed physics basis governing ELM losses, and hence in these projections [2.b.5.6]. Other high-confinement regimes or techniques have been studied that are ELM free or exhibit only small ELMs. However, extrapolation of these regimes to ITER has not yet been demonstrated. Radiation has been used successfully to “buffer” small ELMs, but attempts to use this

## Draft FESAC sub-panel report – Do not circulate

technique on Type I ELMS resulted in only marginal (<25% in JET) reduction in energy deposited [2.b.5.7].

Extrapolation: Uncertainty in the physics understanding of ELMs energy losses makes projections to ITER uncertain, and to an AT Demo even more so. Research on present experiments, on ITER, and on the planned new large tokamaks operating in AT regimes should provide more empirical information and hopefully more fundamental understanding. This research may also lead to techniques for avoiding or mitigating Type I ELMs in Demo.

### Bursts of Energetic Alphas

Some energetic alphas may be lost from burning plasmas in short, intense bursts that could seriously damage PFCs. Such losses have been observed in nonlinear numerical simulations of Alfvén eigenmodes (AEs) and energetic particle modes (EPMs). Some experimental tests have been made and others can be carried on planned non-burning tokamaks. However, the burning plasmas planned in ITER will be essential in the exploration of this issue [2.b.5.8].

Extrapolation: More understanding is needed before the impact of alpha bursts on Demo is understood. ITER will be the major experimental source for this understanding. The higher density AT regime in Demo may mitigate these bursts.

Status and Extrapolation of Approach 2: Stellarators, etc.

This section compares the implications of the four types of off-normal plasma events just described for AT tokamaks with the implications for a stellarator-based Demo. It also comments on the relative maturity of understanding of stellarators and other concepts compared to the tokamak, and the extrapolations needed for Demo.

### Disruptions, Runaway Electrons, Large ELMS, and Bursts of Energetic Alphas

Experiment and theory indicate that stellarators can be operated without disruptions or runaway electron events. However, stellarators can suffer from radiative collapse or other unplanned plasma termination. Though these occur over a relatively slow time scale, they would impose a time varying heat load on reactor components. Stellarator performance must be extended to the high-performance confinement regimes required for Demo to ensure that these off-normal events can be completely avoided in such a regime.

Stellarators can exhibit pedestals and ELMS, but not in all high performance plasmas. For example, ELMs are generally not observed in LHD, and were not observed in the W7-AS high beta experiments. Stellarators are predicted to support EPMs and AEs in a burning plasma at moderate densities, which could result in bursts of alpha particles being expelled. However, stellarators typically operate at sufficiently high plasma density so that these alpha-particle-driven modes are predicted to be stable.(e.g. see Aries-CS). s. As noted earlier, the basic physics of ELM energy losses is not well

## Draft FESAC sub-panel report – Do not circulate

understood, but some empirical evidence in tokamaks indicates that higher density may result in higher collisionality in the pedestal leading to smaller, more easily mitigated ELMs. These conjectures would need to be tested and understood in a stellarator operating in a Demo-relevant regime.

Extrapolation: A stellarator Demo would require the testing of a stellarator configuration that simultaneously demonstrates the required confinement and high-beta in steady-state operation, while avoiding all off-normal events including various types of thermal collapse. Here again “off-normal” means any events that can cause serious damage to PFCs or other structures. For disruptions and runaways, this means maintaining presently observed behavior. For ELMs, it means operating in a confinement regime that reliably does not have ELMs or alpha bursts, it means operating at sufficiently high density so that the relevant modes are not predicted to be unstable. It also requires that the plasma not exhibit any new unexpected type of off-normal event.

The reversed field pinch (RFP) configuration does not exhibit ELMs (it has no H-mode pedestal) or tokamak-like disruptions. But since most of the magnetic energy is due to current in the plasma, disruptions in the RFP would be dangerous. It remains to be seen if disruptions occur as the RFP concept matures toward longer pulse and higher current. Other toroidal configurations are even less well developed, and could exhibit very different off-normal event behavior that might be easier to control or mitigate.

The extrapolation to a Demo would be much greater for the RFP or other configurations. It is not likely that they could advance rapidly enough to be ready for a Demo-regime test on the timescale being considered in this report. However, allowing them to advance at an appropriate pace could lead to improved understanding of the physics underlying off-normal events and help find solutions for tokamaks or stellarators.

### References

- [2.b.5.1] K. Ikeda, et al., Progress in the ITER Physics Basis, *Nucl. Fusion* **47** (6).
- [2.b.5.2] T.C. Hender, et al. “Chapter 3: MHD stability, operational limits and disruptions,” *Nucl. Fusion* **47** (6), S128-S202.
- [2.b.5.3] T.C. Hender, et al. “Chapter 3: MHD stability, operational limits and disruptions,” *Nucl. Fusion* **47** (6), S187.
- [2.b.5.4] T.C. Hender, et al. “Chapter 3: MHD stability, operational limits and disruptions,” *Nucl. Fusion* **47** (6), S130.
- [2.b.5.5] T.C. Hender, et al. “Chapter 3: MHD stability, operational limits and disruptions,” *Nucl. Fusion* **47** (6), S130.
- [2.b.5.6] A. Loarte, et al. “Chapter 4: Power and particle control,” *Nucl. Fusion* **47** (6), S220.
- [2.b.5.7] A. Loarte, et al. “Chapter 4: Power and particle control,” *Nucl. Fusion* **47** (6), S221.
- [2.b.5.8] A. Fasoli, et al. “Chapter 5: Physics of energetic ions,” *Nucl. Fusion* **47** (6), S281.

**2.b.6. Plasma Modification by Auxiliary Systems:** *Establish the physics and engineering science of auxiliary systems which can provide power, particles, current and rotation at the appropriate locations in the plasma at the appropriate intensity.*

In order to achieve the conditions needed for high performance core, edge and SOL plasmas in steady-state with the combined performance characteristics required for Demo, methods need to be developed and applied that can modify plasma parameters using external means. The parameters that need to be modified include plasma temperature, current, density, current profile, pressure profile, stabilization of instabilities, plasma fuel mixture ratio, impurity content, shape and rotation.

A variety technologies have been exploited over the years to produce external plasma manipulation. These can be grouped into the categories of Plasma Heating, Current Drive, Fueling and Exhaust Control, Shaping, and Edge Control. Technologies utilized are high velocity neutral particles, microwaves, radio waves, gas valves, frozen hydrogen pellets, magnetic coils, high speed switching power supplies, and liquid cryogen cooled vacuum pumps. The extrapolations of these technologies to the needs of Demo will be discussed below and range from extensive development needed to readily available commercially. All technologies will have to be evaluated for robustness, reliability and compatibility in the Demo environment.

### a. Plasma Heating

To reach the temperatures necessary for significant amounts of fusion reach energy needs to be deposited into the plasma at various locations. In a high gain plasma, some level of auxiliary plasma heating is required for sustainment and control. New systems and technologies have to be developed or expanded to meet the requirements of Demo Systems which may be used to heat the plasmas are:

1. Ohmic Heating – Magnetic configurations that are based on the tokamak, such as ITER, use internally driven current in the plasma to achieve stability and increased confinement. This form of heating is not sufficient to achieve high fusion gain with attainable values for the magnetic field.
2. Ion Cyclotron Heating– Energy from radio waves in the Ion Cyclotron Range of Frequencies, ICRF, can be transferred to the plasma ions under resonant conditions or to electrons if the wave group velocity is lowered to match the electron velocity. ICRF is the main heating system for most Demo concepts.

ICRF will be used on ITER and other Steady State tokamaks, which will establish a sound technological data base for the performance of ICRF systems. Experience on present day devices are indicating that the antenna-plasma gap should be increased because of lifetime concerns of the antenna, leading to poor plasma-antenna coupling. To mitigate this concern new concepts to enhance RF coupling or provide wider bandwidth need to be pursued, with the realization that any new concept will need to be validated on existing devices prior to implementation on Demo. A proposal for ITER to



provide gas puffing in front of the antenna to increase coupling may not be practical for Demo owing to the large gas load placed upon the plasma, again leading to the need to explore new concepts. The understanding and potential solution to these issues will be helped by the development of improved integrated models of the coupling network, antenna, and wave physics in nuclear environment – validated with experiments and diagnostics.

3. Electron Cyclotron Heating (ECH) – The energy from Electron Cyclotron waves can be transferred to electrons where the wave frequency matches a low-order multiple of the electron gyro frequency, a localized resonance phenomena in most magnetic configurations. The waves can not penetrate a plasma whose density produces a plasma frequency higher than the wave frequency. Because of the highly localized energy deposition, ECH is typically used for localized plasma modification, and plasma breakdown at startup. Since there is no wave-plasma coupling requirements, the EC beam can be simply steered to the location desired using mirrors.

The EC waves are produced in electron tubes called gyrotrons. The gyrotrons developed for ITER operate at 170 GHz, 1 – 2 MW, and cw operations. For several of the Demo concepts these gyrotrons will be sufficient. However, there are versions that operate at high magnetic fields or at high densities. For these applications higher frequency sources, 250 -300 GHz, will be required. Since the economics of EC Systems would improve with larger unit powers, development of higher power gyrotrons would reduce the capital cost of Demo. It is anticipated that for Demo, the plasma facing mirrors will have severe erosion and deposition issues, similar issues exist for ITER, and operating experience on ITER will form a good basis towards Demo.

4. Neutral Beam Injection, NBI – High velocity neutral particles can be injected into the plasma, where when ionized by collisions, they become trapped on the magnetic field lines. These trapped ion transfer their energy to the plasma through multiple collisions with plasma particles. The velocity of the neutral particles is required to be high enough so that most of the energy is deposited in the center of the plasma, but not so high that they penetrate through to the far wall of the vacuum chamber. For ITER 1 MeV neutral particles are required. If the NBI beam is launched in a more tangential direction momentum is imparted to the plasma producing plasma rotation. By having multiple NB Injectors with opposite toroidal tangency, it has been demonstrated that plasma rotation can be controlled.

Most Demo concepts have higher density plasmas than ITER, therefore to penetrate to the core, higher energy  $\sim 1.5 - 2$  MeV, neutral particles would be needed. The technical challenge of developing such high-energy neutral beams has forced all present concepts of Demo to forego the use of NBI as a heating system. NBI for rotation control may still be possible.

### b. Plasma Current Drive

For the tokamak, plasma current plays a key role in providing for plasma stability and confinement. For steady-state operation the plasma current will have to be produced in a

## Draft FESAC sub-panel report – Do not circulate

non-pulsed (non-inductive) manner, and because of the low current drive efficiencies of most non-inductive means, a high fraction of internally generated current (bootstrap current) is desirable. However, high performance plasmas, with high bootstrap currents are susceptible to instabilities, where tearing modes create zones of zero or low bootstrap current. It has been demonstrated on several tokamaks that these zones can be prevented from growing by compensating for the lost bootstrap current by injecting localized current into the zones. Approaches for non-inductive current drive are:

1. Lower Hybrid Current Drive (LHCD) – LHCD is the primary choice of auxiliary current drive for steady state Demo concepts. This comes from the high current drive efficiencies as compared with other wave-plasma current drive technologies.

Long pulse experience from ITER and other Steady State devices could dictate that the launcher-plasma gap be increased because of lifetime concerns, leading to poor coupling; gas puffing in front of the antenna to increase coupling may not be practical for Demo owing to the large gas load placed upon the plasma; alternate launcher concepts need to be validated for effectiveness and functionality prior to use on Demo.

2. Electron Cyclotron Current Drive (ECCD) – Electron Cyclotron waves when launched tangentially to the plasma results in localized current deposition, where the microwave beam crosses the resonant magnetic field shell, by using focusing mirrors the localization of current can be only a few cm wide. This precise localization makes ECCD a prime candidate for suppression of NTM instabilities, and modification of the current density profiles as needed to support high performance plasmas. Issues with ECCD
3. Ion Cyclotron Current Drive (ICCD) – Energy from radio waves in the Ion Cyclotron Range of Frequencies, ICRF, can be transferred to electrons if the wave group velocity is lowered to match the electron velocity. This requires antennas with multiple straps with the phasing between straps adjusted to produce the appropriate  $k$  parallel. Issues for ICCD sources and launchers are similar to those for ICRF heating.
4. Neutral Beam Injection Current Drive (NBCD) - By aligning the neutral beam injectors such that the path of the neutral particles are approximately tangential to the plasma core, energy is preferentially transferred to the electrons by collisions, driving current in the direction of the beam. Owing to the large size of the neutral beam, it is normally used as a central current drive tool, although by aiming the injector slightly off-center some off-axis current drive can be achieved, albeit with a broad profile. Issues for NBCD technology are similar to those for NBI heating.

### c. Fueling and Exhaust Control

Operation of Demo at high fusion power production, will require that the fuel concentration in the core of the plasma be controlled continuously, with replacement of D-T fuel and removal of He ash. Particularly important will be the ability to measure the isotopic mix in the core, enabling the optimization of the fusion performance.

In most operating magnetic confinement devices fueling is achieved by gas puffing, which is also planned for ITER but is not expected to be effective at core fueling. For

## Draft FESAC sub-panel report – Do not circulate

ITER fueling of the core is to be achieved by high speed frozen D-T pellets injected on the low or high field edge of the plasma. Fueling of a Demo reactor poses significant scientific and technological issues beyond our present knowledge of fueling tokamak plasmas. The primary issues arise from the steady state nature of a Demo and its anticipated operation at high density with significant tritium fueling throughput requirements. The areas where further knowledge will be needed for Demo are in fueling physics, isotopic control, steady-state operation, tritium handling, and technology reliability. New technological solutions for core fueling will most likely be needed, which should be first tested on test stands and later tried on operating devices such as ITER or other magnetic confinement devices.

### d. Shaping

The ability to manipulate the plasma shape is critical to obtaining optimum plasma performance. Critical shape characteristics that need controlling are; elongation, triangularity, edge-wall gap, radial position, separatrix position, divertor footprint, etc. These manipulations are achieved by magnetic coils located appropriately around the plasma, connected to high speed power supplies, responding to commands from the Plasma Control System, which utilizes a variety of sensors to predict the plasma shape real-time.

In general, shape control coils must be located far from the plasma edge, providing room for shielding the superconducting material. However, the need to manipulate the outer surface of the plasma with three-dimensional fields, for example with coils designed to inhibit the presence of Edge Localized Modes (ELM), or Resistive Wall Modes (RWM), may require coils placed relatively close to the plasma. This will likely rule out the use of superconducting materials and require the development of water or gas cooled coils that can survive the heat and neutron fluence near the plasma boundary. Edge pressure control by resonant magnetic perturbation (RMP) coils is being evaluated by the ITER Design Review Program

### e. Edge Rotation Control

Edge rotation can improve performance by producing radial velocity shear, which acts to stabilize micro-turbulence and thereby improving plasma confinement. With much lower input torque than most current experiments and lower  $\rho^*$ , predictions suggest that the rotation in ITER may be below the threshold where the radial velocity shear can be effective. Thus alternate means to enhance plasma rotation may be needed. Two methods have been demonstrated with this capability, neutral beams injected tangentially, and ICRF waves (primarily Ion Bernstein Waves, IBW), which can drive plasma poloidal flows. RF driven poloidal flow and tangential neutral beam injection is not presently part of the ITER base line program, however these could be added as part of an ITER AT enhancement program.

## Draft FESAC sub-panel report – Do not circulate

**2.b.7. Magnets:** *Understand the engineering and materials science needed to provide economic, robust, reliable, maintainable magnets for plasma confinement, stability and control.*

Magnets are the quintessential enabling technology for magnetic confinement and are typically the most expensive component in the construction of MFE experiments. While the current level of understanding for fusion-relevant superconducting magnets is sufficient for a device like ITER, we note that designs for two leading tokamak reactor studies, ARIES-RS with  $B_T=8$  T and ARIES-AT with high-temperature superconductors, are significant extrapolations from ITER. Improvements in performance, cost, reliability and maintainability will only be obtained after significant research. The goal of this research is to have the capabilities in hand for producing more reliable, more compact, higher-field, lower-cost magnets for future devices like Demo.

Currently, superconducting magnets are designed with large safety margins because of incomplete understanding of their properties. For example, existing codes cannot self-consistently predict the distribution of strains and electrical current in superconducting cable. Also lacking is the ability to predict crack growth and damage in composite materials. Large safety margins are also needed because the lack of adequate quench detection diagnostics requires very conservative magnet protection designs. Nuclear effects including heating in the conductor and damage to thermal and electrical insulators have not been fully characterized. High-temperature superconductors have the potential to enable operation at higher magnetic field in the fusion geometry. However this is a less mature technology and will require significant research before they can be employed reliably in fusion devices. For example, high-temperature superconductors, quench propagation slows about three orders of magnitude from 10m/s to 10mm/s, requiring development and integration of new techniques (optical perhaps) for quench detection.

The focus in magnet research for fusion is often on the toroidal field coils since they are the largest and require the highest fields. However the poloidal field coils used for shape control and current drive and the helical or modular coils need for stellarators raise additional issues. Control coils, for their function, must carry time varying current which leads to internal heating. This demands care in their design and in the plasma control systems which drive them. Coils for stellarators require very complicated and very precise control of geometry. Recent experience in construction of stellarators with modular coils suggests that the challenges are formidable.

With further research, a wide range of opportunities are available to improve superconducting magnet performance. Advances are possible in the underlying superconducting material – whether standard or high-temperature variants are used. The latter, because they maintain their high critical current-densities at higher magnetic fields, offer the possibility of higher-field reactor operation, increasing the headroom with respect to plasma physics limits. Higher temperature operation could simplify the cryogenics systems and reduce cooling power requirements. Better structural materials or better designs could allow higher stress. The following opportunities for improvement in superconducting magnet designs have been identified:

## Draft FESAC sub-panel report – Do not circulate

1. Improved modeling and testing techniques to validate integrated simulation of thermal, electrical and mechanical properties of superconducting magnet systems.
2. Improvements in low-temperature superconducting strand, including current carrying capacity and stability
3. Improvements in high-temperature superconducting strand
4. Innovative approaches to design fusion magnets with high-temperature superconductors
5. Innovative quench diagnostics and protection systems to allow higher performance and lower design margin
6. Improvements in conductor conduit to allow better tolerance to NbSn heat treatment
7. Electrical and thermal insulators capable of operating in nuclear environment
8. Better insulator properties for cooling lines, which could allow higher voltage and lower current operation
9. Improved manufacturing techniques to lower costs

In realizing these opportunities, a vigorous magnet research program that studies materials and components could be much less expensive than construction and testing of large prototypes.

### *Extrapolation parameters for low temperature superconductors*

Metric	Current Value	Required Value	Extrapolation
$J_{\text{EFF}}$	500 A/mm <sup>2</sup>	1000 A/mm <sup>2</sup>	X2
$J_{\text{STABILITY}}$	150-225 A/mm <sup>2</sup>	300 A/mm <sup>2</sup>	X 1.5
Cost/Fusion-Watt	20 \$/W (ITER)	2 \$/W (ARIES-AT)	X 10
Radiation fluence to insulators	<10 <sup>9</sup> Rads (ITER)	>3x10 <sup>10</sup> Rads (ARIES-AT)	X 100

As noted above, high temperature superconductors offer additional opportunities for magnet improvements, but will require substantial research and development. These materials have shown the ability to carry high current densities at fields beyond the capacity of low-temperature materials. The principle challenge for exploiting high-temperature superconductors arises from their physical form. These conductors are mostly forms of copper oxide crystals and inherently difficult to form into the large-scale wires or plates. Instead, high-temperature superconducting magnets are typically made by winding flexible, though fragile, tapes. Innovative designs, using thick films deposited on structural materials are being pursued. It is possible that such designs could allow construction of demountable superconducting magnets which would ease maintenance for fusion systems.

Many proposals for future experiments require long-pulse, high-performance resistive magnets (usually copper or copper alloys). For example, spherical tokamak geometry is hard to obtain if substantial neutron shielding is required over the inner leg of the toroidal

## Draft FESAC sub-panel report – Do not circulate

### *Extrapolations for high temperature superconductors*

<b>Metric</b>	<b>Current Value</b>	<b>Required Value</b>	<b>Extrapolation Factor</b>
Cost	\$160/kA-m	10/kA-m	15
$J_{EFF}$ (Current Density)	500 A/mm <sup>2</sup>	1000 A/mm <sup>2</sup>	2
Piece size (unbroken length)	200 kA-m	50 MA-m	250
Design Stress	60 – 500 MPa	100 – 250 MPa	~1

field magnet, as it is for superconductors. And while heating of normal conductors by radiation is not quite as severe as for superconductors, questions remain about activation, neutron damage to structural components and the survival of thermal and electrical insulators. Copper magnets are typically cheaper and more robust than those made with superconductors, but must be carefully designed for heat removal in long-pulse applications. Such magnets, if they are to be operated economically, must be designed to minimize electrical power dissipation. Demountable joints, which are desirable for preserving the maintainability of fusion systems, are relatively straightforward for resistive magnets. Although a fairly mature technology, there are opportunities to improve the performance of resistive magnets. Historically, magnets for fusion systems cost 20 to 90 times the cost of the bare conductor. Experts believe that with simplified conductor and coil designs a reduction of at least 2 could be realized. The following opportunities for improvement in resistive magnet designs have been identified:

1. Improvements in conducting materials, including new alloys or composites
2. Extended performance and operating life for thermal and electrical insulators, especially resistance to radiation damage
3. Sliding demountable joints or fixed demountable joints
4. Improved conductor joining processes, to avoid degrading the structural properties of conductor near the joints.
5. Improvements in manufacturing techniques to reduce fabrication cost and time
6. Improvements in modeling the coupled thermal, electrical and mechanical properties of magnets including nuclear damage, embrittlement, crack growth, etc.
7. Innovative designs which allow higher field and/or lower cost.
8. Optimization of active cooling designs to extend the available pulse length and/or field strength

As with superconducting magnets, realizing these improvements will require a vigorous research program.

#### **2.b.8. Plasma-Wall Interactions:** *Understand and control of all processes which couple the plasma and nearby materials.*

The complex coupling of a high-temperature plasma to material surfaces remains a major scientific challenge. Pressure balance, including ram pressure and collisions with neutrals, is approximately maintained along the field lines which connect the main plasma with the divertor surface, but intense heat fluxes are driven by temperature gradients along these

## Draft FESAC sub-panel report – Do not circulate

field lines. The ultimate interaction with the divertor surface involves pre-sheath gradients, and sheaths which accelerate impurities preferentially into the divertor plate, resulting in enhanced sputtering erosion. Cross-field transport can result in large particle flux, and significant heat flux, being deposited at the main chamber first wall, or at the entrance to the divertor. Whereas transport along open field lines is generally believed to be classical, cross-field transport is not understood. There is an effort to build a science based model to explain edge plasma conditions from the top of the pedestal to material surfaces, but the effort is just beginning. As complex as these phenomena are during normal operation, additional difficulties are encountered in fully understanding off-normal events, which can result in vaporization of plasma facing component surfaces and self-shielding. Demo concepts are typically predicted to have more severe edge plasma conditions than ITER.

a. Erosion of the plasma facing surface of the first wall is caused by physical sputtering, chemical mechanisms yielding volatile species, or evaporation at high temperature. Not all of these processes are applicable to all materials. Many of the mechanisms are dependent on plasma particle flux and temperature. If the PFCs are composed of more than one material there can be either a reduction or increase in erosion depending on the materials. Research on mixed material effects is relatively new. Erosion and redeposition may lead to the formation of dust that may contain tritium and create a risk of strong reactions with coolant in case of a loss of coolant accident. The complex interactions between the hydrogen and helium particle flux to a surface mixed with multiple impurities are not well understood. ITER will provide important data on erosion because it is a long pulse device and because the baseline configuration has mixed materials, however, the step to Demo requires an increase in duty factor by at least a factor of 10. Control of the interaction between the plasma and surrounding materials has been accomplished through the use of coatings applied to the surfaces, special conditioning plasmas that scrub the wall, and baking of the device.

Extrapolation: The integrated plasma operating time on existing devices is one to two orders of magnitude less than ITER and, on Demo, will be one to two orders of magnitude longer yet. This means that the thickness of redeposited films will be proportionally thicker. The deposition will alter the surface properties in ways that have not been measured. On existing machines, the ratio of time spent conditioning the walls to the time spent operating with high performance plasmas is much greater than one. For Demo this ratio must be much less than one. ITER has the ability to explore ratios around one. All plasma-wall interactions are sensitive to the surface temperature of plasma-facing components. No device in the world program, including ITER, will be capable of operation with a first wall temperature in the range of ~600C, as is desired for Demo.

b. Impurity generation is the result of erosion of the plasma facing wall. All of the erosion mechanisms produce a flux of impurities toward the plasma.

Extrapolation: There is increasing understanding of the transport of impurities from the wall or divertor to the main plasma but extrapolation is required to simulate Demo. In particular, the understanding of the transport of impurities in the scrape-off layer and pedestal region must be increased. ITER will provide important data if the edge has sufficient diagnostics.

## Draft FESAC sub-panel report – Do not circulate

c. Tritium retention has been observed on both of the DT tokamaks. Between 20 and 50% of the tritium injected in the plasma was retained in the graphite plasma facing materials. Deuterium experiments on other devices have been analyzed to show much lower retention but the interpretation of the data is much more difficult. ITER will provide extremely accurate data on retention because of the high tritium input and long pulse length. Demo will have much higher neutron fluence than ITER and operate at higher temperatures. Tritium retention on Demo must be accurately predicted using a validated code as part of the licensing process.

Extrapolation: Because of safety considerations the in-vessel releasable tritium inventory in ITER is limited to ~100 gm. Experience shows that this level may be accumulated in 100-1000 discharges on ITER. Because of higher operating temperatures and greater tritium consumption on Demo, the allowed inventory is likely to be reduced. Coupled with low tritium retention, plasma facing materials chosen for Demo must also have low impurity emission (whether due to physical sputtering, chemical erosion, or evaporation). The much thicker redeposited layers on ITER and Demo will have the ability to trap much larger quantities of tritium. It will be much more difficult to remove trapped tritium from the thicker layers. ITER must partially solve this problem but Demo will require even more improvement because of increased operating time (roughly ten times). ITER should provide data on the equilibration of particles between the wall and the plasma. Demo will probe even further into the regime where higher operating temperatures and greater neutron damage increase the depth to which particles can communicate with the plasma.

d. Particle and heat loads (including particle control, plasma compatibility with liquid PFC) See Sections 2.b.6 and 2.b.9.

e. Particle recycling and pumping requirements See Section 2.b.6.

### Associated coupling and integration issues

Ideally, a plasma facing material would have the low sputter and evaporation yield of a high Z refractory metal, the low Z of Be or C, and low tritium retention simultaneously. It is a delicate optimization process to find a material that can be constructed from the existing elements and do the best job of satisfying these seemingly conflicting requirements. Plasma wall interactions can alter the scrape-off layer plasma (impurity radiation, recombination, temperature dependent sheath, etc.).

**2.b.9. Plasma Facing Components:** *Understand the materials and processes that can be used to design replaceable components which can survive the enormous heat, plasma and neutron fluxes without degrading the performance of the plasma or compromising the fuel cycle.*

a. Overall Design issues (including heat flux removal enhancement techniques (e.g., swirl tape), surface shape optimization or generalization for margin, regulatory requirements, stress and strain allowables and testing regimes.) It is theoretically possible to optimize the shape of a plasma facing component to minimize the heat flux to the surface. In practice, the lack of ability to perfectly align the component with field lines or



## Draft FESAC sub-panel report – Do not circulate

irregularities in the field structure make the application of such an optimized surface subject to higher peak heat flux than a less optimized surface that is designed to accommodate unexpected irregularities in alignment. A variety of heat removal enhancement devices have been tested for the coolant channels in a PFC. The majority of those experiments have been done for water cooling.

Extrapolation: Only a few preliminary experiments have been done for gas coolants which are preferred for Demo. Improved heat transfer techniques that work for water cooling are generally not applicable for gas cooling. New methods must be invented and tested. While the properties of the major materials used for PFC have carefully measured properties, the joint between the plasma facing material and the heat sink is typically a few microns thick and is composed of intermetallics whose properties are uncertain and where measurements of properties after neutron irradiation are not available. Extensive heat flux testing of new designs must be conducted on test stands and the designs applied to long pulse fusion devices (non-nuclear) before the designs can be considered for Demo. In addition to being the first burning plasma device, ITER will also test the design process for actively cooled components with significant neutron fluence (~0.3 DPA). ITER will provide the first data on failure modes and effects and the ability to replace actively cooled PFCs in a fusion device. Since Demo will have 100 times the neutron fluence and 2-5 times more heat flux, the understanding of plasma facing component design must be gained from experiments in addition to ITER. Moving liquid PFC designs offer both unique capabilities to remove heat and resist neutron damage and unique challenges for design and modeling.

b. Materials Issues (including reduced activation, adequate thermal conductivity (after irradiation), high operating temperature capability (600-1000C), joining methods to heat sink, coolant compatibility (oxygen content of He gas) Efficient removal of the plasma heat flux to PFC requires materials with moderate to high thermal conductivity. Because of the desire to operate PFC at high temperature for efficient power conversion, solid materials must be refractory. Only a few candidate starting elements can be considered for PFC because of these restrictions. The lowest activation material in this category is tungsten. Tungsten has a high ductile to brittle transition temperature (DBTT) that is raised by neutron irradiation. Alloying W to decrease the DBTT always decreases the thermal conductivity. Research in Japan and elsewhere is providing clues as to how to improve the properties of tungsten (and molybdenum) without a pronounced decrease in thermal conductivity.. Helium gas cooling of refractory metals requires very low oxygen levels in the He gas. There is a small research effort in Russia to develop joining materials that can be used for W and Mo PFCs.

Extrapolation: Demo will require creation of new improved refractory metal alloys (most likely tungsten but molybdenum, niobium, tantalum, and vanadium are possible candidates depending on the heat flux). These new materials will have to be fully characterized in both the unirradiated and neutron irradiated condition. Effective methods for oxygen contamination control in helium gas must be discovered. Robust methods for joining refractory plasma facing materials to refractory heat sinks are necessary. Refractory heat sinks are likely to need creative joining techniques also.

## Draft FESAC sub-panel report – Do not circulate

c. Thermal Issues (following neutron irradiation, including cyclic fatigue, thermal creep, fracture toughness, fracture mechanics at interfaces.) Neutron irradiation typically hardens materials while decreasing ductility and fracture toughness.

Extrapolation: See materials section b above.

d. Mitigated disruptions that may cause significant melting of the entire first wall

Extrapolation: Some of the disruption and runaway electron mitigation schemes could cause intense heat loads on the first wall. Owing to the inherently higher surface-normalized energies in Demo, achieving effective mitigation without this side effect will be even more challenging in Demo than it will be in ITER. These intense heat loads will cause brief high stress at the heat sink to plasma facing material interface. It is not known whether such a sudden stress will lead to fracture of an irradiated interface layer.

e. Reliability/maintainability (following neutron irradiation, including mean time between failures mean time to repair, safety issues related to loss of coolant, loss of flow or loss of vacuum, diagnosis of engineering performance) There is very little experience with actively cooled PFCs on fusion devices. The database is insufficient to determine the failure mechanisms and the mean time between failures. Off-normal events create spikes of temperature and stress that may create cracks or defects that can lead to failure during subsequent normal operation. A great deal of research must be done to understand the failure mechanisms and develop the statistics needed to guide preventative maintenance. ITER will help to develop this data but more engineering diagnostics are needed to effectively gather the data from ITER.

Extrapolation: Since Demo will have helium gas cooled refractory metal PFCs, the database needed to qualify designs for Demo will have to be developed on machines other than ITER. If those devices are non-nuclear, they must have long pulse lengths, operate at high temperature, and exclusively use remote maintenance techniques for exchange and repair of PFCs.

f. Tritium Issues (with neutron irradiation, including tritium (hydrogen) effects on materials and permeation) Permeation of tritium through PFC to the coolant must be included in the design of the coolant systems. Some materials (e.g., Ti, V, Ta) are known to be susceptible to hydrogen embrittlement. Tritium retention in PFCs must be limited to avoid safety issues related to T inventory or release during accidents.

Extrapolation: Permeation will only be significant for devices that have large tritium throughput or fluence to the PFCs. It can only be measured on components tested in devices like CTF or Demo. Laboratory measurements will provide data on representative specimens of the designs chosen (measurements on irradiated specimens are also possible).

## Draft FESAC sub-panel report – Do not circulate

g. Liquid Surface PFCs (including liquid compatibility with structures, MHD effects on moving conducting liquids due to spatially and temporally varying magnetic fields, HDT pumping capability, He pumping capability, nozzles and flow collection structures, test facilities) Liquid surface PFCs avoid the majority of the deleterious effects of neutron irradiation, erosion, and off-normal events. There are no thermal stresses in a liquid so cyclic fatigue and creep are not an issue. The peak operating temperature of a liquid surface is limited by evaporation from the liquid surface. The precise temperature limit depends on the transport of the evaporated to the plasma which is uncertain. In general, the expected temperature limits are below those desired for the highest thermal efficiency (400-600 C rather than 600-1000 C). A flowing liquid surface has a remarkable ability to remove heat flux since the coolant is directly exposed to the heat flux. Some liquid coolants (Li) can efficiently pump hydrogen atoms but the ability to pump He atoms has not been demonstrated. The major issue to be solved is the effect of currents induced in the liquid by either spatially or temporally varying magnetic fields. Other sources of current include plasma thermal gradients, plasma motion, and particle flux transients such as ELMs. Models are being developed to compute the response of free surface conducting liquids to the induced currents. In fusion applications both the Hartman number and the Magnetic Interaction Parameter are large which complicates the simulations. Experiments that can be used to check the modeling have only been performed at parameters that are not very similar to fusion devices. Experiments on fusion devices are very few and only performed on small low field devices.

Extrapolation: While restrained static liquids have demonstrated beneficial effects on plasma performance, moving surface liquids have never been successfully deployed on a fusion device.. The sequence of events required to apply liquid surfaces on Demo will include laboratory tests of flowing free surface liquids in spatially varying magnetic fields to begin validation of MHD models; application of flowing liquids as PFCs in a near term fusion device having a few second pulse length, scale-up experiments in a long pulse fusion device (e.g., KSTAR, JT60-SA, etc.); and prototype designs tested in a CTF like device. These experiments will confirm the MHD models used for design, stability of the liquid in the presence of plasma, and particle recycling and pumping effects. Flowing liquids are a large extrapolation from experience on fusion devices but they are considered because they can eliminate many of the problems that confront solid surface PFCs. Liquids have both high risk and high pay-off.

### h. Susceptibility/robustness to off-normal events

See Section 8 above for a discussion of the effects of off-normal events on PFCs. Actively cooled PFCs have greater sensitivity to off normal events because the portion of the component closest to the plasma must be thin to allow heat flow to the coolant. In general, more severe or frequent off-normal events lead to lower the maximum heat flux requirements for normal operation and shorter lifetimes before replacement.

Extrapolation: The majority of fusion devices operate with thermally thick plasma facing components (the plasma heat input is stored in the specific heat of the material and released slowly after a discharge and is therefore robust against off-normal events). The one notable exception is TORE SUPRA which has provided valuable insight on the

## Draft FESAC sub-panel report – Do not circulate

design of actively cooled PFCs. Several devices either under construction or planned may provide further insight before ITER operates, although none of them will be DT devices. Because the stored energy in Demo is larger than ITER, the effects of off-normal events will be more severe on Demo.

### Associated coupling and integration issues

Selection of the plasma facing material on a PFC must meet all the requirements described in section 8 while simultaneously transmitting plasma thermal energy to a heat sink. Because of the need for high temperature (600-1000 C) refractory materials must be used but such materials generally have high Z and make impurity control more difficult. There is a very limited database with high plasma performance simultaneous with plasma facing surfaces composed entirely of high Z materials.

### **2.b.10. RF Antennas, Launching Structures and Other Internal Components:**

*Establish the necessary understanding of plasma interactions, neutron loading and materials to allow design of RF antennas and launchers, control coils, final optics and any other diagnostic equipment which can survive and function within the plasma vessel.*

Functional internal components (antennas, sensors, mirrors, control coils, etc.) must meet the criteria of other plasma facing components (see section 2.b.9) in terms of resistance to high ( $\sim 1-10 \text{ MW/m}^2$ ) heat and neutron fluxes and acceptable levels of impurity production, while in addition maintaining the capability to perform heating, diagnostic, or control functions. Internal components can also suffer damage if they lie in the path of particle fluxes produced in off-normal events; an important example of such a scenario is the production of runaway electrons during a tokamak plasma disruption.

Internal RF antennas and microwave launch structures or mirrors present special challenges, as these components are energized with high intensity electromagnetic fields with amplitudes  $\sim 10-100 \text{ kV/m}$ . These fields can accelerate particles along field lines and create DC plasma sheath structures: both these phenomena can lead to focused particle and energy fluxes on the antennas or launchers themselves, as well as other components or surfaces intersected by the field lines.

Most presently operating high-power toroidal fusion experiments are pulsed, and have limited neutron fluxes (only those resulting from D-D operation). For these experiments, heat loads are handled inertially, and particle deposition on components can either be tolerated (as with antennas or limiters), limited by the use of shadowing or shutters, or periodically removed or replaced (as is required for mirrors, windows, or lenses to continue functioning). Long-pulse, non-nuclear experiments like Tore Supra add active cooling to all internal components, and development of these techniques has occurred progressively based on experience over  $\sim 20$  years. Newer non-nuclear, superconducting long pulse devices include (LHD [operating] and W7X, JT-60SA, KSTAR, EAST [under construction]). Ultimately, experience with neutron irradiation facilities (e.g. IFMIT, SNS) and high heat flux facilities as well as D-T operation on ITER will be required to fully test and qualify these components.

## Draft FESAC sub-panel report – Do not circulate

For remotely maintained D-T experiments, the performance criteria for internal components become more demanding, as replacement or repair is complicated. Shadowing of components may be required in some cases (e.g., mirrors) where extensive particle deposition can impede function.

The key capabilities required for the development and deployment of effective and durable internal components in fusion reactors are:

- a. *Reliable and verified techniques for predicting particle, heat, and neutron fluxes on passive components (e.g. sensors, mirrors, etc) in realistic geometry in both normal and off-normal operating conditions.* These are three-dimensional models of the charged particle, neutron, and electromagnetic radiation source functions in the reacting plasma that can be used to calculate in detail the distribution of fluxes. Development of these capabilities requires detailed modeling and targeted experiments with appropriate edge plasma and radiation diagnostics.
- b. *Reliable and verified techniques for computing self-consistent heat and particle fluxes to high-power, energized components (RF antennas, microwave launchers, etc) which interact with and alter the edge plasma.* This development requires the integration of fully 3-D RF heating codes with realistic antenna and confinement device geometry, and targeted experiments with innovative diagnostics that can measure plasma parameters in the edge plasma wherein heating power is flowing into the plasma and exhaust power is flowing out to the active component.
- c. *Structural, shield and coating materials with which to construct internal components, and appropriate joining/bonding technologies. These materials must be able to withstand the intense heat, particle and neutron fluxes of a fusion reactor for reasonable operation lifetimes, without excess impurity generation, and will need to be fully qualified in materials testing facilities.* These requirements are essentially similar to those for other plasma-facing components and can use the same testing techniques. However, use for active components like antennas may add additional materials requirements for conductivity, etc. Layered sandwich materials or coating may be required to assure the function of components like antennas or mirrors.
- d. *Verified 3-D design concepts and techniques for cooled internal components.* In addition, active components delivering power to the plasma need cooling both for their power delivery function and for absorbing flux from the plasma.

**2.b.11. Fusion Fuel Cycle:** *Learn and test how to manage the flow of tritium throughout the entire plant, including breeding and recovery.*

- a. Solid breeders (including irradiation sintering, operating temperature, tritium permeation to sweep gas, tritium permeation to coolant and from sweep gas piping.

## Draft FESAC sub-panel report – Do not circulate

neutron multiplier material and structure, breeding material and structure, TBR control) The solid breeder materials developed for fusion are typically ceramic materials ( $\text{Li}_2\text{O}$ ,  $\text{LiTiO}_3$ ,  $\text{LiZrO}_3$ ) formed into pebbles to ease diffusion of Tritium created into the sweep gas (He). Since these materials operate at high temperature and absorb large neutron fluence, they are susceptible to sintering and loss of porosity. Solid breeders require a neutron multiplier (Be or  $\text{TiBe}_{12}$  pebbles). The multiplier can react with oxygen contamination in the He sweep gas, which might be controlled by Ti added to the multiplier. The pebble size is set by the diffusivity of T in the materials. Insufficient diffusion will cause excess T inventory in the breeder and safety issues. The rate of tritium breeding is very sensitive to the neutron spectrum and hence the layers of material between the plasma and the breeder. If more severe off-normal events must be absorbed by the first wall then the first wall will require greater thickness and lead to lower tritium breeding. Since tritium breeding ratios are only slightly greater than one, loss of tritium by permeation through the sweep gas piping will complicate the tritium recovery system (more gas to be processed from more pipes).

Extrapolation: Measurements of sintering of ceramic breeders have been made on unirradiated materials only. The effect of neutrons on the sintering is unknown. Addition of Ti to the multiplier has been shown to greatly decrease oxygen reaction, but the fabrication of the very brittle  $\text{TiBe}_{12}$  material has not been perfected. Various permeation barriers have been tested in neutron environments and nearly all have reduced permeation by a factor or roughly two not 10 to 100 as desired. Development of permeation barriers will be useful for applications other than fusion, e.g., tritium production in commercial reactors.

b. Liquid breeders (including material compatibility and corrosion, MHD effects, thermal insulators, tritium permeation through pipes of heat exchanger, structural material choice, TBR control) Liquid breeders span a wide range of atomic number from pure liquid Li to  $\text{Li}_2\text{BeF}_4$  (Flibe) to PbLi eutectic. Only pure Li needs a neutron multiplier. Both PbLi and Flibe have very low tritium solubility and need very effective tritium permeation barriers that are compatible with corrosive liquids. Double wall pipes with a He sweep gas between the pipes may be necessary for liquid breeders (concentration of T in the sweep gas will be low). Flowing the liquid through a section of pipe made from a highly permeable material like Pd is considered for liquid breeders except Li. Liquid Li has high solubility for tritium and the T must be chemically separated.

Extrapolation: No effective permeation barriers have been found for liquid Flibe or PbLi that are compatible with the desired operating temperature. Chemistry control of the mixed liquid breeders has not been tested at any scale close to that required for Demo. Chemical separation of T from liquid Li has not been demonstrated at rates even close to that required for Demo.

c. Recovery (including separation of T from He gas or liquid metal, recovery of low concentration T from permeation protection, process test experiment) See above.

## Draft FESAC sub-panel report – Do not circulate

d. Tritium processing (including isotope separation and impurity removal, steady state control of processing at high throughput (~10X ITER), accountability to about +/- 2 gm, chemical plant handling kilogram quantities of T, systems integration) The tritium processing system for Demo must have about 10 times the throughput of the ITER system. In addition, the Demo plant must operate continuously (ITER can use batch mode). Because tritium is a controlled nuclear material, the plant must be able to account for tritium with an accuracy of about  $\pm 2$  gm (out of the kilograms being processed).

Extrapolation: There has never been a tritium plant capable of meeting the Demo needs anywhere. One order of magnitude extrapolation for a chemical plant usually requires 5-10 years for development and testing even if the need for special accounting for tritium, which is required for licensing, is neglected.

### Associated coupling and integration issues

Circulating tritium inventory and accident consequences (T release and no evacuation criteria, exclusion zone)

**2.b.12. Power Extraction:** *Understand how to extract fusion power at temperatures sufficiently high for efficient production of electricity or hydrogen.*

Power Extraction is a fundamental challenge for an attractive fusion energy source. The scientific issues encountered in fusion power extraction are substantially different than other energy sources including fission. Examples of these unique attributes include a) a very high surface heat flux and potentially high peaking factors, b) a complex volumetric heating source involving both plasma products (neutrons, particle, and radiation) as well as nuclear reaction in the power extraction components, c) strong impact of electromagnetic field (both static and dynamic) on heat transfer, d) large temperature and stress gradients which can derive a multitude of complex physical phenomena, e) compatibility with the fuel cycle (tritium production and extraction), f) complex geometry, and g) an evolving material properties (e.g., due to radiation effect). In addition the power extraction components are inherently coupled to plasma performance (e.g., plasma-material interaction on the first wall and divertor), as well as the power conversion cycle and safety.

The fusion environment encountered by the power extraction components represents an uncharted scientific territory with extreme conditions. Some of the scientific challenges associated with the power extraction in the fusion environment are described below.

a) Understanding thermo-fluid dynamics of plasma facing components of power extraction: About 1/5 of fusion power appears on the plasma facing components of power extraction and should be recovered efficiently. “Traditional” approaches to high-heat flux components are not applicable to fusion because of potentially high peaking factors, large particle fluxes, electromagnetic loads, evolving material properties (due to both neutrons and particles fluxes), and geometrical constraints. This requires developing new understanding of heat transfer and fluid dynamics in regimes that have not been explored

## Draft FESAC sub-panel report – Do not circulate

thoroughly before -- mainly through modifying coolant flow profiles (turbulent or transition to turbulent flows, impinging jets, etc.)

b) Understanding thermo-fluid dynamics in the blanket: Utilizing lithium-bearing, liquid metal alloys as the coolant have significant advantages in extracting nuclear heating as well as tritium breeding. Because these alloys are electrically conducting, their thermo-fluid behavior is strongly affected by the electromagnetic field confining the plasmas or generated by the plasma itself. The flowing liquid metal will experience  $v \times B$  forces (magnetohydrodynamic effects) that are many times larger than viscous and inertial forces. These forces have a large impact on flow profiles and heat transfer conditions. For fusion application, the science of liquid-metal MHD thermo-fluid dynamics should be extended to regimes with large variations in and gradients of the  $v \times B$  forces, time-dependent EM fields generated by the plasma operation, and intense nuclear heating.

c) Understanding the generation and transport of “impurities.” During the operation of the power extraction system, a large amount of “impurities” is generated. These include a) material implemented and/or diffused into the plasma facing components of the power extraction components, b) material produced by chemical or physical interaction of constituents of power extraction components, c) material produced due to the interaction of neutrons with the constituents of power extraction components such as tritium and transmutation by-products. Understanding the generation and transport of these “impurities” in the fusion environment and with large temperature and stress gradient represent major scientific challenges.

d) Multi-physics phenomena. The fusion environment encountered by the power extraction components represents an uncharted scientific territory with extreme conditions. Because of the combined environmental loading conditions and the interactions among the disparate physical elements and materials of the plasma chamber, it is expected that many multi-physics effects will be encountered.

e) Understanding the life-limiting and failure mechanisms of power extraction components. Reliable operation of power extraction components requires a detailed understanding of possible life-limiting or failure mechanisms which does not exist. In addition to the extreme conditions of the fusion environment, synergetic effects may play a major role in producing new life-limiting phenomena.

Associated coupling and integration issues:

Direct linkage with plasma facing components, tritium fuel cycle, material, plasma operation, and safety issues.



**2.b.13. Materials Science in the Fusion Environment:** *Understand the basic materials science phenomena for fusion breeding blankets, structural components, and plasma diagnostics and heating components in high neutron fluence areas.*

The unique combination of intense high-energy neutron fluxes, high heat fluxes, tritium production, and high temperature coolants associated with a fusion energy system poses immense challenges to conventional construction materials. New damage-resistant materials need to be developed for future fusion reactors, where harsh operating conditions will exist in terms of extreme temperatures (interface with plasma temperatures  $>10^8$  K), heat fluxes ( $>10$  MW/m<sup>2</sup> in fusion divertor regions, approaching the radiant flux at the sun surface) and high mechanical stresses. Furthermore, complete destruction of local atomic bonding will occur regularly within nanoscale neutron-induced displacement cascades in the materials surrounding the fusion plasma, resulting in hundreds to thousands of transient displacement events for every atom over the lifetime of the materials near the fusion first wall and blanket region. There are also complexities associated with changing chemistry in the material due to neutron-induced transmutation events. Therefore, empirical-based materials development, such as what was successfully used in the 1960s for the evolutionary design of fission reactors, is not a viable option for fusion energy (it is too time consuming and costly, with high probability of failure). New science-based methods incorporating improved cross-cutting fundamental knowledge of basic radiation damage mechanisms in materials are needed to guide the pathway to materials capable of sustained high performance operation in this extreme environment.

Multiscale simulations of materials for fusion energy systems need to provide accurate and computationally efficient predictions of physical phenomena for spatial dimensions spanning ten orders of magnitude and temporal scales spanning more than twenty orders of magnitude. The current state of the art approach for multiscale materials modeling involves passing information between a series of specialized codes operating at different length and time scales. The “coarse-graining” that occurs as information is passed to computational codes at progressively larger length and/or time scales necessarily involves approximations (data truncation) that can introduce poorly quantified errors into the hybrid model predictions of materials behavior. A new theoretical and simulation paradigm for predicting and extrapolating materials performance over vast length and time scales would transform the utility of predictive computational modeling for designing future fusion energy systems.

Seven of the scientific challenges associated with materials in the fusion environment are described in the following.

a. Investigate the constitutive mechanical properties of structural and breeding blanket (neutron multiplier, lithium-containing ceramic) materials after short- to long-term thermal exposure and fusion DT neutron irradiation (tensile, fracture toughness) including joints and dissimilar material transition regions. The intense neutron fluxes in the regions surrounding the plasma will damage the structural integrity of the solid materials, which could lead to premature failure of key components.

Status and Extrapolation: The current knowledge base for reduced-activation structural materials systems exposed to fusion-relevant neutron irradiations is nonexistent for displacement damage and transmutant helium levels above  $\sim 1$  displacement per atom (dpa) and  $\sim 10$  appm He, respectively, which is about two orders of magnitude below the projected Demo operation conditions. Multiscale models and experimental validation are needed to examine the impact of fusion-relevant helium-rich ( $\sim 10$  appm He/dpa) environments on neutron-irradiated structural materials, particularly at damage levels above 10 dpa. Similarly, the mechanical behavior of breeding blanket materials exposed to fusion-relevant neutron irradiation conditions needs to be determined so accurate models of radiation-enhanced pebble bed sintering and other phenomena can be developed. Acquisition of this improved understanding of deformation and fracture mechanisms may enable a quantum advance beyond the current high-strength, low-ductility/toughness paradigm for conventional structural materials (i.e., typically high strength is achieved at the expense of substantial reduction in ductility, and vice versa).

b. Examine the dimensional stability and phase stability of model and prototypic structural and breeding material systems due to fission and fusion neutron irradiation. Engineering designs for fusion energy systems likely cannot tolerate more than a few percent dimensional change in the blanket structure. Furthermore, radiation-induced changes in the phases comprising the material may lead to chemical incompatibility with the flowing coolants or surrounding materials, or may cause degradation in mechanical properties.

Status and Extrapolation: Current radiation damage theory predicts that void swelling and dimensional growth due to irradiation creep will be strongly enhanced in a fusion-relevant helium-rich environment ( $\sim 10$  appm He/dpa) compared to typical fission reactor neutron conditions ( $\sim 0.1$ - $0.5$  appm He/dpa). Improved physical models and experimental validation are needed for fusion-relevant irradiations above 1-10 dpa, including experimental and modeling investigations of the performance (dimensional stability) of new materials systems engineered at the nanoscale for superior radiation resistance.

c. Establish the scientific basis for new high temperature structural design criteria. The US regulatory approval basis for structural materials in high temperature nuclear energy systems currently does not exist. Mechanical deformation mechanisms such as creep-fatigue and ratcheting are not well understood from a fundamental perspective.

Status and Extrapolation: The current method for determining the allowable safe operating conditions for structural materials at elevated temperatures (non-irradiation environments) involves lengthy and costly experimental tests on multiple heats of a given material by multiple laboratories. The derived empirical curves for properties such as simultaneous thermal creep and mechanical fatigue conditions are only valid for one narrowly-defined chemical composition; any change in the composition of the allow requires another complete set of costly and time-consuming tests. The physical phenomena that control the mechanical behavior of structural materials at elevated temperatures need to be determined, including possible synergistic effects when multiple

## Draft FESAC sub-panel report – Do not circulate

deformation processes (e.g., thermal creep and cyclic mechanical fatigue) are present. This will form the basis for formulating a science-based methodology for determining the safe operating conditions for materials at elevated temperatures in both non-irradiation and neutron irradiation environments.

d. Develop a quantitative predictive model for thermal conductivity degradation of neutron irradiated metals and ceramics, so that new materials can be designed to avoid large radiation-induced decreases in thermal conductivity. Avoidance of large degradation in thermal conductivity is of particular importance for plasma facing materials and feedthrough insulators for plasma heating systems.

Status and Extrapolation: Although it is well-known that neutron irradiation can cause reductions in the thermal conductivity in metals and ceramics due to creation of point defect clusters and small solute precipitates that increase electron and phonon scattering, respectively, existing models do not have the ability to make accurate quantitative predictions of the thermal conductivity degradation. Development of a robust physical model for thermal conductivity degradation may lead to development of new nanoscale chemical formulations that would minimize this radiation-induced degradation.

e. Discover the underlying physical mechanisms controlling the chemical dissolution rate of materials exposed to coolants, including mass transfer phenomena associated with surrounding dissimilar solid materials.

Status and Extrapolation: It is known that the chemical dissolution rate of materials exposed to a flowing coolant is controlled by a number of factors including the chemical solubility of the material in the coolant, the coolant flow rate (or more generally the chemical gradient profile in the coolant next to the material), and the temperature gradient within the flowing loop system. However, a predictive unified theory for chemical dissolution in a flowing non-isothermal coolant loop has not yet been established and dissolution rate data obtained by different laboratories often vary by more than one order of magnitude due to lack of knowledge about which key experimental variables need to be controlled. Furthermore, potential effects of irradiation on enhancing or suppressing corrosion rates are unknown for the current list of proposed coolants for fusion energy systems. The roles of coolant velocity, viscosity, heat capacity, solubility behavior of the exposed material, and piping dimensions (laminar vs. turbulent flow and wall boundary effects) need to be determined in order to develop a predictive science-based corrosion model. The role of radiation (radiolysis and other mechanisms such as radiation induced segregation of surface layers or accelerated passivation) on corrosion mechanisms needs to be included in this model.

f. Explore the mechanisms responsible for radiation-induced changes in electrical resistance and optical properties in dielectric materials, in particular the effect of ionizing radiation on radiation-induced conductivity which is of importance for several plasma diagnostic systems.

Status and Extrapolation: Early models for radiation induced conductivity (RIC) underpredicted the magnitude of the effect in ceramic insulators by several orders of

## Draft FESAC sub-panel report – Do not circulate

magnitude. The current knowledge base on RIC is composed almost entirely of experimental observations and empirical correlations. At the present time it is unknown if there are any practical chemical composition and processing modifications that could be made to mitigate the magnitude of RIC. Radiation induced degradation in the transparency of optical materials is also of concern for plasma diagnostic systems. Additional phenomena such as radiation induced electro-motive force (RIEMF) can create large unexplained spurious signals in plasma diagnostic instruments; an improved understanding of these effects is needed for the accurate operation of diagnostic components in a fusion neutron environment.

g. Exploration of reduced-activation and reduced-decay-heat compositions that simultaneously provide high structural material performance.

Status and Extrapolation: Due to consideration of safety (short term decay heat and volatilization) and long-term environmental (Class C shallow waste disposal) issues, only a handful of elements in the periodic table are suitable for construction of “reduced-activation” materials for DT fusion systems. Emerging computational thermodynamic tools and first principles modeling can provide guidance for the development of promising high-performance structural materials systems, but experimental validation of the long-term stability of these materials under mechanical stress at high temperatures and fusion-relevant irradiation conditions is needed. These new “materials by design” compositions need to simultaneously satisfy waste volume and low activation disposal classification criteria, and ideally would include some material systems that potentially could be recycled for reuse in future-generation fusion energy systems.

Associated coupling and integration issues

- Direct linkage with plasma facing components, tritium fuel cycle and power extraction design issues

- Structure should remain intact following all realistic off-normal conditions

- Maintain acceptably low tritium inventory during operation (materials with high hydrogen solubility are generally not allowed)

**2.b.14. Safety:** *Demonstrate the safety and environmental potential of fusion power: to preclude the technical need for a public evacuation plan, and to minimize the environmental burdens of radioactive waste, mixed waste, or chemically toxic waste for future generations.*

a. Computational tools are needed to analyze the response of a fusion system to an off-normal event or accident.

Extrapolation: The US Fusion Safety Program has developed a series of advanced system level (and in some cases component level) computational tools to analyze the response of a fusion system to an off normal event or accident. We have also developed the underlying database needed to characterize the fusion radiological source term that could be mobilized in these events. We continue to work with ITER and the French regulator to gain acceptance of these US tools in the licensing of ITER. It would be an

## Draft FESAC sub-panel report – Do not circulate

important precedent to have such tools ultimately accepted for future licensing activities for fusion in the US. Key needs include the requirement for integrated off normal behavior testing to validate the predictions of system behavior identified in the safety analysis. Verification and validation of such tools will be required by any regulator and properly designed and scaled experiments will be needed to provide the necessary validation data. This type of integral testing can be expensive and needs to be incorporated into the respective technology development plans. Development of system level safety analysis tools for Demo needs to continue. New models in the areas of tritium transport, dust and hydrogen explosions, and PbLi/water chemical reactivity need to be developed for present system level analysis codes. Development of coupled activation and 3-D neutronics codes that accurately predict the activation source terms and doses around the torus using the actual 3-D geometry is needed. Code development will continue in the fission industry and as new system level safety codes become available these codes should be adapted to fusion to provide fusion with more up to date system level safety analysis tools. Also more fusion-specific sophisticated safety analysis codes are also needed in the area of magnet arcing. Progress in this area is presently being limited by availability of arcing data, electromagnetic model development, and available computing power. Progress is needed in this area given the high stored energies of a fusion reactor magnet system. Finally, all codes to be used for licensing will have to be validated and verified (V&V) to NRC requirements.

b. Understanding and quantifying the fusion source term will be required for licensing activities.

Extrapolation: In the area of source terms, the two with greatest uncertainty today are dust and tritium. In terms of dust the key uncertainties are the magnitude of dust generated in the machine, its location and the potential for explosive dust mixtures in the presence of hydrogen and air in certain accident sequences. We anticipate that we will learn much about the generation and distribution of dust from ITER, however the use of plasma facing materials other than those in ITER may affect the characteristics of the dust produced (quantity and size), and the cleanup methods that will have to be employed. For the high temperature breeding blankets anticipated in Demo key tritium issues include accountancy, control and permeation. With very tight normal operating releases for tritium releases to the environment (especially liquid releases) and the ability of tritium to permeate easily through high temperature materials, control of the tritium flows through the plasma chamber and the blanket, the associated cooling systems, and the power conversion systems will be a challenge. The tritium through-put in ITER will be relatively low compared with Demo, and experience with high through-put prior to Demo is desirable. Additionally, there is the potential for tritium to permeate to areas that were not designed for tritium retention, thus understanding tritium permeation is extremely important. R&D is needed (e.g., tritium permeation barriers—it is important to point out that tritium barriers will be have different under irradiation relative to out-of-pile) to help better define and hopefully resolve the issue prior to Demo.

c. Qualification of fusion components in the fusion Demo environment will be required to validate the design and to demonstrate safety roles of key components..

Extrapolation: Separate effects and integral irradiation testing in a fusion component test

## Draft FESAC sub-panel report – Do not circulate

facility (CTF), fission reactors, particle accelerators could provide a portfolio of high damage (> 10 dpa) performance testing data for advanced fusion materials and the blanket and divertor components; combined with ITER results these data can make the licensing case to qualify Demo components. Beyond safety and licensing concerns, testing and qualification activities are required for investment protection thus effort is needed by the relevant technology communities to develop coherent qualification strategies for the key components of Demo. These strategies must recognize the investment protection needs, reliability requirements, and safety aspects of the components.

d. A waste management strategy for fusion must be developed.

Extrapolation: Beyond the need to avoid the production of high-level waste, there is a need to establish a more complete waste management strategy that examines all the types of waste anticipated for Demo and the anticipated more restricted regulatory environment for disposal of radioactive material. Demo designs should consider recycle and reuse as much as possible. Development of suitable waste reduction recycling, and clearance strategies is required for the expected quantities of power plant relevant materials. Of particular concern over the longer term could also be the need to detritiate some of the waste prior to disposal to prevent tritium from eventually reaching underground water sources. This may require special facilities for the large anticipated fusion components. The fission industry will be developing recycling techniques for the Global Nuclear Energy Partnership (GNEP) and the US Nuclear Regulatory Commission (NRC) is developing guidelines for the release of clearable materials from fission reactor wastes both of which may be of value to fusion.

e. Experience with large scale remote handling will be important prior to Demo

Extrapolation: Remote handling of large components will be instrumental to the success of fusion. Activation levels in commercial plant will be much higher than in ITER, and ITER will have significant downtime relative to a commercial plant (and will not be under the same time constraints as a commercial plant), thus additional experience with remote handling of large components is desirable prior to Demo.

### Associated coupling and integration issues

Safety and environmental issues are clearly cross-cutting, and this task must be closely coordinated with all the science and technology issues.

## **2.c Prioritization**

The panel was charged with prioritizing the scientific and technical questions facing the program prior to Demo. While not defining precisely what was meant by the term, it is clear that what was wanted was guidance on which areas would benefit most from additional emphasis or investment. As the panel developed the list of issues, it was clear that none were unimportant and that all would have to be resolved eventually. Thus it is crucial for readers to understand that the panel's judgments on priorities should not be

## Draft FESAC sub-panel report – Do not circulate

taken as a recommendation to abandon certain broad lines of research. Rather, they are meant to inform decisions concerning which areas to stress now. In almost all research areas, some level of ongoing core competency is required for a coherent program.

### 2.c.1. Approach

The task of prioritization was approached by first defining a set of criteria, scoring and weights. These were based entirely on issues related to charge 1; assessment of gaps and U.S. opportunities were evaluated separately. Three criteria were developed and defined as follows:

*Importance: Importance for the fusion energy mission and the degree of extrapolation from the current state of knowledge*

1. Resolution would lead to improvement in end product, moderate extrapolation from current and planned experiments
2. Resolution would lead to improvement in end product, major extrapolation from current and planned experiments
3. Problem must be solved, moderate extrapolation from current and planned experiments
4. Problem must be solved, major extrapolation from current and planned experiments

*Urgency: Based on level of activity required now and in the near future.*

1. Only low levels of activity are required now, significant work could begin in 15 years to meet 35 year plan schedule (i.e. waiting on ITER results is acceptable)
2. Only low levels of activity are required now, but significant new activities must begin in 10-15 years to meet 35 year plan schedule
3. Ongoing work must continue at a moderate level and/or be increased or augmented by significant new activities in 5-10 years to meet 35 year plan schedule
4. Work must continue at a high level or significant new work must begin in the next 5 years to meet 35 year plan schedule

*Generality: Degree to which resolution of the issue would be generic across different designs or approaches for Demo.*

1. Solutions to this issue are narrow and unlikely to be applicable to range of likely Demo instantiations
2. Solutions to this issue are narrow but likely to be applicable to range of likely Demo instantiations
3. Solutions to this issue are generally applicable

The relative weighting for the three criteria was roughly 3:2:1 respectively (though results were not terribly sensitive to this weighting). Each panel member evaluated each of the 14 issues against these three criteria. The votes were then averaged and the results circulated for further discussion. This procedure was repeated three times as we refined the criteria and definitions of the issues to resolve ambiguities and discrepancies.

## 2.c.2 Discussion of Priorities

After considerable discussion, a consensus was reached on the relative priorities of the 14 broad technical issues previously identified. These were then grouped into three tiers, the tiers defined to suggest an overall judgment on the state of knowledge, the relative requirement and timeliness for more intense research for each issue.

**Tier 1:** *solution not in hand, major extrapolation from current state of knowledge, need for qualitative improvements and substantial development for both short and long term*

- Plasma Facing Components
- Materials

**Tier 2:** *solutions foreseen but not yet achieved, major extrapolation from current state of knowledge, need for qualitative improvements and substantial development for long term*

- Off-normal events
- Fuel cycle
- Plasma-wall interactions
- Integrated, high performance burning plasmas
- Power extraction
- Predictive modeling
- Measurement

**Tier 3:** *solutions foreseen but not yet achieved, moderate extrapolation from current state of knowledge, need for quantitative improvements and substantial development for long term*

- RF launchers and other internal components
- Plasma modification by auxiliary systems
- Control
- Safety and environment
- Magnets

## 2.d U.S. Strengths and Opportunities

Separately from priorities of issues, the panel evaluated U.S. strengths and opportunities to contribute in each of the 14 areas. While it was clear that we want to avoid duplication of international efforts in making these evaluations and recommendations, the panel felt that the U.S. shouldn't shy away from competing where we have the abilities to make strong contributions. We separately evaluated the U.S. position with respect to four questions. 1. What were areas of current and historical U.S. strength or leadership? 2. In what areas was the U.S. in greatest danger of losing leadership or competitiveness given current trends? 3. What were areas where the U.S. had an opportunity to sustain leadership by strategic investment? 4. In what areas could the U.S. gain leadership by making significant new investments? (At the same time we note again the need to



## Draft FESAC sub-panel report – Do not circulate

maintain a level of core competency in all relevant areas as these underpin current and future programs.) The results of our deliberation:

1. Areas where the U.S. has leadership
  - Measurement
  - Predictive modeling
  - Control

Further areas where the U.S. is strongly competitive

  - Plasma-wall interactions
  - Integrated, sustained, high-performance plasmas
  - Safety/environment
2. Areas where the U.S. is in particular danger of losing leadership or competitiveness given current trends and international investments.
  - Measurement
  - Control
  - Antennas and launchers
  - Materials
  - Integrated, sustained, high-performance plasmas
  - Plasma-wall interactions and Plasma facing components
  - Safety/environment
  - Magnets
3. Areas where the U.S. has opportunities to sustain leadership through strategic investment
  - Measurement
  - Predictive modeling
  - Control
  - Plasma-wall interactions
4. Areas where the U.S. has opportunities to gain leadership through significant investment
  - Plasma facing components
  - Materials



## **Chapter 3    Assessment of Available Means To Address Issues**

To answer the second part of the charge, the panel was required to review current and existing programs and assess their capabilities to address the key issues we had previously identified. The inventory was carried out using published literature, project documents and contacts with key personnel. For each facility or program, we summarized the mission and objectives, technical capabilities, plans and schedules. Evaluation of existing programs was more straightforward as their basic capabilities are known and their plans well documented. The capabilities for planned facilities are literally and figurative less concrete and a greater degree of interpretation and judgment was required. This was particularly true for assessing the long-term program for ITER, beyond the baseline  $Q=10$ , ELMy H-mode mission. In this case, we have to consider both the capabilities of the facility and the long term interests and priorities of the ITER partners.

### **3.a. ITER**

ITER is a collaboration among seven parties (Europe, Japan, USA, China, South Korea, Russia and India) to build the world's first reactor scale fusion device located in Cadarache, France. The ITER Project expects to finish major construction in 2016 ITER is presently scheduled to begin DT fusion experiments in 2020, and to operate for 20 years.

#### **Mission and Objectives**

The overall programmatic objective of ITER is "to demonstrate the scientific and technological feasibility of fusion energy for peaceful purposes." [3.a.1]. This is to be achieved in baseline ITER H-mode operation by producing a nominal 500 million watts of fusion power in 300-500 second inductively driven pulses. These burning plasmas are expected to be dominantly self-heated by the fusion alpha particles with an energy gain  $Q$  (the ratio of fusion power produced to external power applied to heat and control the plasma) of ten. These plasmas will begin to explore the nonlinear coupling of a self-heated fusion plasma to the plasma transport, MHD stability, and plasma edge interaction with the boundary – a key integration of scientific issues. The duration of the baseline operating mode is sufficient to achieve stationary conditions for energy transport, particle, impurity and alpha ash and heat removal in the divertor. Since helium particles (alpha particles) are created by the fusion reactions, the determination of impurity levels will be more complex in fusion plasmas. Engineering ITER will test the physics and technologies of particle and energy exhaust under conditions relevant to the design of

## Draft FESAC sub-panel report – Do not circulate

Demo. The high fusion power and plasma temperature in ITER also enables the alpha particle pressure to be a significant fraction of the total plasma pressure, a key factor in enabling study of the new physics to be explored in a burning plasma. The design does not preclude the possibility of controlled ignition (or higher gain) for short durations if enhanced confinement is attained.

Secondary technical objectives of ITER [3.a.1] are:

1. Demonstrate steady-state operation using non-inductive current drive with the ratio of fusion power to input power for current drive of at least 5. This could be accomplished with additional investments to allow modestly-advanced operation with confinement enhanced by 30% relative to H-mode operation and normalized  $\beta_N$  increased by 50% to  $\approx 3$ . This configuration is expected to produce a self-driven plasma current of  $f_{bs} \approx 50\%$ , and would require a non-inductive plasma current drive system capable of producing 4.5MA with the desired profile. Fusion powers of 350 MW could be sustained for  $\sim 3000$  s limited by the capability of the superconducting coils and cryogenic system to remove the heat produced by neutron heating.

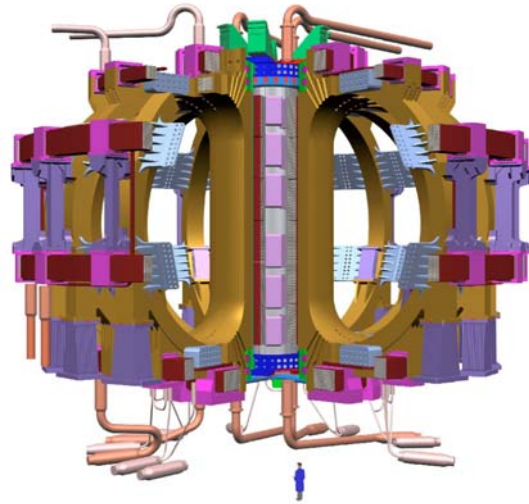

*The ITER superconducting coil set*

2. Demonstrate availability and integration of technologies essential for a fusion reactor; ITER is close to the physical scale expected for a Demo/fusion reactor, and will demonstrate the integration of superconducting magnets with an energy producing tokamak environment. Steady-state plasma fueling and heat removal technology will be demonstrated on ITER at power densities within a factor of  $\sim 4$  of those needed for Demo. ITER will also provide a major test of tritium handling technologies including development of low tritium retention plasma facing components and rapid tritium reprocessing systems. The reactor scale vacuum vessel and remote handling systems will be a major step toward the technology needed for Demo. The operation of these engineering systems over the planned 20-year operational period will also provide a convincing demonstration of the safety benefits of fusion.

3. Test tritium breeding module concepts with a 14MeV neutron power load on the first wall  $\geq 0.5\text{MWm}^{-2}$  and fluence  $\geq 0.3\text{MWam}^{-2}$  that would lead in a future reactor to tritium self-sufficiency, extraction of high grade heat, and electricity production. This could be achieved with additional investments to fund a Test Blanket Module (TBM) program to construct and test up to three TBMs simultaneously in mid-plane ports.

## Basic Parameters for ITER

ITER will be the first fusion device built with a scale similar to a fusion power plant. The physical size and strength of the magnetic field for ITER plasma is comparable to a Demonstration (Demo) fusion power plant. ITER is intentionally designed to be somewhat larger than a power plant Demo plasma to provide a performance margin since some of the advanced science and technology features needed for a Demo are not yet fully validated on existing facilities. Key parameters for ITER are listed in Table 1.

Table 3.1. ITER Parameters and Operational Capabilities. [3.a.1]

Parameter	Attributes
Fusion power	500MW (700MW) <sup>a</sup>
Fusion power gain ( $Q$ )	10 (for 400 s inductively-driven burn); 5 (for steady-state (3,000 s) objective)
Plasma major radius ( $R$ )	6.2m
Plasma minor radius ( $a$ )	2.0m
Plasma vertical elongation(95% flux surface/separatrix)	1.70/1.85
Plasma triangularity (95% flux surface/separatrix)	0.33/0.48
Plasma current ( $I_p$ )	15MA (17 MA) <sup>b</sup>
Safety factor at 95% flux surface	3 (at $I_p$ of 15 MA)
Toroidal field at 6.2m radius	5.3 T
Installed auxiliary heating/ current-drive power	73MW (110MW) <sup>c</sup>
Plasma volume	830m <sup>3</sup>
Plasma surface area	680m <sup>2</sup>
Plasma cross section area	22m <sup>2</sup>
Neutron wall loading	0.57 MWm <sup>-2</sup>
Neutron damage dose	0.3 dpa

<sup>a</sup> Increase possible with limitation on burn duration of 120 s.

<sup>b</sup> Increase possible with limitation on burn duration of 200 s.

<sup>c</sup> A total plasma heating power of 110MW may be installed in subsequent operation phases.

## Operational Scenarios and Expected parameters

The base line operating mode of ITER is the inductive H-Mode, which will satisfy the overall programmatic purpose of ITER and provide access to the burning plasma physics regime. The physics basis for H-Mode operation is strong in terms of fundamental understanding and empirical extrapolation from existing experiments. The hybrid scenario has improved confinement, increased beta and reduced requirements for inductive current drive relative to the H-Mode. This will allow longer duration inductively driven discharges to study the physics and power handling capabilities for

## Draft FESAC sub-panel report – Do not circulate

plasma durations ~1,000s. The steady-state discharges would be facilitated by  $\approx 50\%$  self-driven current with the remaining 50% of the plasma current driven by external non-inductive current drive such as neutral beams, ECCD, FWCD or LHCD. This operational mode will be relevant to steady-state operation in a Demo, and will provide capability for nuclear testing of test blanket modules.

*Table 3.2 – ITER Operation Scenarios[3.a.1]*

Scenarios	Plasma Current (MA)	Non-Inductive Fraction	H98 (y,2)	$I_i$	$\beta_N$	Fusion Power (MW)	Burn Duration (s)
Inductive H-mode (#2)	15	0.15	1.0	0.8	1.8	500	~400
High Power H-Mode						700	250 <sup>a</sup>
Hybrid Mode (#3)	~12	~0.50	1–1.2	0.9	2–2.5	400	$\geq 1000^a$
Steady-State Mode(#4)	~9	1.00	$\geq 1.3$	0.6	$\geq 2.6$	350	$\leq 3000^a$

<sup>a</sup> limit is imposed by ability of the cooling system to remove nuclear heating of TF conductor.

The plasma parameters expected for ITER under various operating modes estimated using a 0-D code bases on ITER98(y,2) scaling are shown in Table 3.

*Table 3.3 Expected ITER Plasma Parameters (for H-Mode and AT mode)\**

	Inductive H-Mode	Hybrid Mode	Advanced Mode (4)
R/a (m/m)	6.2/2	6.2/2	6.35, 1.85
$B_t(T), I_p(MA), q_{95}$	5.3, 15, 3	5.2, 13.8	5.18, 9.5, 5.3
$\langle n \rangle (10^{20} m^{-3}), \langle n \rangle / n_G$	1.01, 0.85	0.93, 0.85	0.67, 0.82
$\langle T_e \rangle, \langle T_i \rangle$ keV	8.8, 8.0	8.4, 9.6	12.5, 12.3
$W_{th}(MJ)$	320	~300	287
$\langle p \rangle$ (atm)	3	~3	3
$P_{fusion}, P_{NB}, P_{RF}$ (MW)	400, 33, 7	400, 33,40	356, 30, 29
$P_{fusion}/V_p, (MWm^{-3})$	0.48	0.48	
Q	10	5.4	6
$P_{rad}$ (MW), $P_{loss}/P_{L-H}$	47, 1.8	~40, ~2	37.6, 2.59
$Z_{eff}$	1.66	~1.8	2.07
$\beta_T$ (%), $\beta_N, f_{bs}$ (%)	2.4, 1.8, 15	, 2.5, 30	2.77, 2.95, 48
$\beta_\alpha$ ,	0.22	~0.3	0.43
$\tau_E, H_{H98(y,2)}$	3.7, 1.0	2.6, 1	3.1, 1.57
Burn Time (s)	500	1,000	3,000

\*Parameters from Lackner/Campbell Snowmass 2002,  $\tau_{He}/\tau_E = 5$  for all cases

### Plasma Heating and Current Drive Capabilities

ITER will have extensive plasma heating and current drive capabilities to facilitate the access to, and exploration of new burning plasma regimes described above. Negative ion based deuterium neutral beams at an energy of 1 MeV are under development for central

## Draft FESAC sub-panel report – Do not circulate

heating. Up to 33 MW of NB power will be injected using two beamlines with the potential for a third beam line. Ion cyclotron frequency RF at frequencies of 40–50 MHz will be coupled using two mid-plane launchers integrated with port plug shield assemblies. During startup operation, 20MW of EC will be used either in two upper ports to control neoclassical tearing modes, or in one equatorial port for main heating or current drive. EC will allow use of four allocated top ports for the power upgrade. No additional equatorial ports are therefore foreseen for this system. A lower hybrid system at 5GHz and powers up to 40 MW will be used for off-axis current drive required for advanced scenarios.

*Table 3.4 Initial set-up and possible upgrade scenarios of heating and current drive systems.*

Power Source	Start-up Power(MW)	Scenario 1 Power(MW)	Scenario 2 Power(MW)	Scenario 3 Power(MW)	Scenario 4 Power(MW)
NB(1 MeV)	33	33	50	50	50
IC(40–50 MHz)	20	40	20	40	20
EC (170 GHz)	20a	40b	40b	40b	20b
LH (5 GHz)	0	20	20	0	40
Total	73	133	130	130	130

The total installed power is given in the table. Note: the total maximum power into the torus is limited to 110 MW.

### **First Wall and Divertor Capabilities**

ITER will extend our knowledge of particle and power handling in a fusion plasma in terms of power handling, pulse duration, power density, off-normal events, reactor relevant materials and technology. The lower single null divertor consists of 54 remotely maintainable cassettes mounted on the floor of the vacuum vessel. The divertor entrance and dome are tungsten and the vertical targets will be either carbon or tungsten with choice to be made at the time of procurement. The first wall consists of 10 mm Be armor on a water cooled Cu substrate. The divertor and first wall are designed for power densities of  $\sim 0.5 \text{ MWm}^{-2}$  on the first wall and  $5 - 10 \text{ MWm}^{-2}$  on the divertor targets under steady-state conditions. The nominal distribution of the plasma heating power (150 MW) is: core radiation 30-50 MW, mantle radiation 30-70 MW, SOL radiation 30-60 MW, divertor radiation 30–60 MW and conduction to the divertor 30-60 MW. The most significant challenges have to do with the large transient heat loads due to ELMs, major plasma disruptions and disruption mitigation.

Particle handling under fusion plasma conditions will be a major accomplishment of ITER. The PFCs and divertor must pump the D,T, He ash exhaust efficiently while providing very low retention of tritium inside the vacuum vessel and pumping system. Retention fractions of  $\sim 0.025\%$  are needed in a power plant while TFTR and JET achieved  $\sim 40\%$  in DT operation.

### Key Issues To Be Addressed By ITER

a. Predictable high-performance steady-state burning plasma: ITER will enable major advances in our state of knowledge to accurately predict and then create high-performance steady-state burning plasmas. The baseline operation of ITER will provide key tests of our understanding of plasma confinement, MHD stability, energetic alpha particle behavior and edge plasma interactions with the first wall in a plasma relevant to fusion energy production. The operation of ITER in modestly-advanced modes will extend our understanding toward the regimes needed for a fusion Demo. However, the ability of ITER to explore Demo-like advanced modes is limited due to constraints from nuclear heating of the TF superconductor.

b. Boundary – Plasma Material Interface: A major result of ITER will be to extend our understanding of the boundary-plasma material interface in a fusion plasma environment. This will include a detailed understanding of the edge DT plasma, control of the wall interaction including tritium retention (with a cold first wall), as well as the development of materials and robust components that are appropriate for off-normal events in a neutron environment.

c. Off-Normal Events: ITER is a major step beyond existing devices in terms of energy/m<sup>2</sup> deposited on plasma facing components by ELMs and major disruptions, and will provide a large increase in our understanding and ability to avoid, control and mitigate ELMs and disruptions.

d. Harnessing Fusion Power: The plasma exhaust processing systems of ITER will be required to operate at conditions approaching those required of a Demo system. A Test Blanket Module Program including high temperature modules could provide initial data under low levels of neutron irradiation and therefore validate some aspects of design codes for breeding blanket modules on a Demo. However, materials used for ITER structural components and first wall components would not be suitable for a fusion Demo.

### Schedule

The present ITER plan is to begin ITER construction by the end of 2007 with project completion and first plasma to occur in early 2016. After several years of operation with H and then D, ITER would begin DT experiments in approximately 2020 with the baseline H-Mode capability ( $Q = 10$ , 500 MW for 400s) achieved in 2022, and 100% non-inductive current drive capability in 2023 [3.a.2]. The ITER International Project Organization (IPO) is currently reviewing the design of ITER and any modifications are to be determined by the end of 2008.

[3.a.1] Progress in the ITER Physics Basis - Chapter 1: Overview and Summary, Nucl. Fusion, **47** (2007) S1-S17.

[3.a.2] ITER Web Site, <http://www.iter.org/gifs2/operationschedule4.jpg>



### 3.b Other Existing and Planned Confinement Experiments

#### 3.b.1. ASDEX-Upgrade

##### Mission/Program

ASDEX-Upgrade (AUG) is a mid-sized divertor tokamak located at the Max-Planck-Institut für Plasmaphysik (IPP) in Garching, Germany. The primary mission for the machine has been support for the ITER design and operation, with focus on integrated, high-performance scenarios, the plasma boundary and first wall issues. The machine is similar in many respects to DIII-D, however, to be prototypical for ITER and other reactors, the machine was designed with a sparse set of shaping coils outside the toroidal field coils. This feature imposes limits the amount of shaping which can be achieved.

Concepts for divertor geometry and PFC materials have been tested as part of an intensive research program into divertor and boundary plasma physics. Plasma wall interactions are studied at high-power and in high-performance discharges investigating power loading to first wall components, control of impurities and helium transport and exhaust. Discharges have been developed which can dissipate most of their input power via edge impurity radiation. AUG is currently testing tungsten as a first wall material via thin coatings over the older graphite tiles (with thicker coatings over the divertor strike points). Coverage is now up to about 85% of the vessel. Levels of tungsten in the plasma have increased, but are generally at acceptable levels - though overcoating with boron is required for some operational scenarios. Generation of impurities during RF heating has been a particular concern with the high Z first wall. Reduction of carbon concentration in the plasma (which is less than the reduction in graphite tile area) and carbon migration have also been studied. An extensive set of diagnostics is employed to test models of the divertor and plasma edge including parallel transport, radiation, atomic physics and neutral recycling.

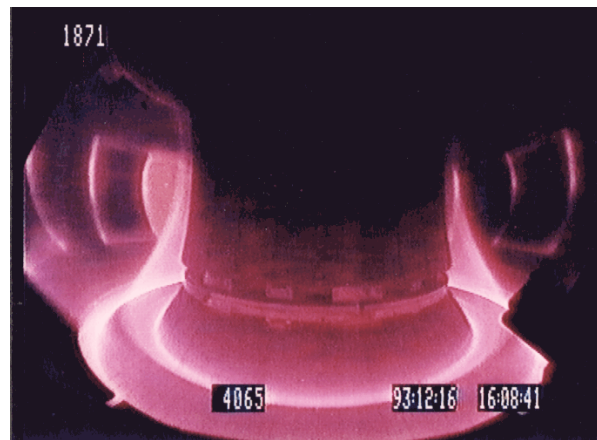

*Photograph of a plasma in ASDEX-Upgrade*

AUG has a broad program for the study of MHD stability and  $\beta$  limits. Emphasis has been on active control of sawteeth and neoclassical tearing modes (NTM) via localized ECH and ECCD. In some cases the deposition width has been artificially broadened to simulate the situation on ITER where the marginal island size will be proportionally smaller than on current devices. Plans include real-time feedback on the NTM position and ECCD deposition location. A second important area of MHD research is the study of large scale magnetic perturbations and their interaction with fast particles provided by the ICRF and NBI systems. Both high-frequency (e.g. TAE) and low frequency (e.g. NTM)

## Draft FESAC sub-panel report – Do not circulate

MHD modes have been investigated. ASDEX is also equipped to measure the heating from localized fast particle loss.

Research is carried out to classify, predict and mitigate disruptions. A database has been developed which attempts to classify every discharge termination. Neural nets as well as more traditional approaches have been taken to predicting various classes of disruption and using these predictions to trigger fast puffs of impurity gases for mitigation. Transient heat loads from disruptions and ELMs have been characterized by infra-red imaging of the divertor and first wall. ELM loss energy and localized heating has been studied for various regimes and techniques for reducing these heat loads have been tested. ELM pacing with repetitive small pellets has shown some promise and may be employed on ITER. Regimes which have only small ELMs have also been investigated.

Basic studies of transport and turbulence have tested models for ITG and TEM in steady state and transient plasmas. ECH has been successfully employed to provide localized time dependent heating and validated models for "stiff" electron temperature profiles via the flux/gradient response. The predicted stability threshold for TEM onset was also tested in these experiments. Particle transport, especially at low collisionality, has been studied and led to predictions of moderately peaked profiles for ITER. AUG contributes actively to the international database for the prediction of confinement on ITER. Research on edge transport barriers (H-modes) have included studies of the structure and scaling of the pedestal, the underlying physics of the H-mode density limit, physics and transport properties of ELMs and the connection between edge and core parameters. Considerable effort has gone into understanding the edge operating space especially the appearance of different ELM types.

Investigations into the physics of internal transport barriers (ITBs) have stressed the creation and triggering of barriers; sustainment via internal pressure gradients and localized current drive. Scenario modeling and development of steady-state regimes has included the hybrid mode, with weak shear, and advanced modes with reversed shear. The hybrid studies have emphasized prediction and extrapolation to ITER, while the AT studies are at a more basic level, emphasizing operational ranges, beta limits and NTM control. Current drive tools include NBI, ECCE and ICRF fast waves.

### **ASDEX-Upgrade Parameters & Capabilities**

$B = 3.1 \text{ T}$

$I_p = 0.4 \text{ MA} - 1.6 \text{ MA}$

$R = 1.65 \text{ m}$

$a = 0.5 \text{ m}$

$\kappa = 1.8, \delta = 0.4$

$P_{\text{NBI}} 20 \text{ MW @ } 60 \text{ keV and } 100 \text{ keV}$

$P_{\text{ICRH}} 6 \text{ MW @ } 30 - 40 \text{ MHz}$

$P_{\text{ECRH}} 4 \text{ MW @ } 140 \text{ GHz}$

Pulse duration  $< 10 \text{ s}$

### Schedule/Plans

In the near future, the last set of graphite tiles will be overcoated with tungsten providing an entirely carbon-free first wall. Significant upgrades are planned for the ECCD system. An additional 4 MW will be added including two-frequency (105/104 GHz) and step tunable gyrotrons whose frequency can be adjusted to 105/117/127/140 GHz on a shot to shot basis. A new set of steering mirrors will be installed which would allow feedback control of the poloidal launching angle during a pulse. Taken together, these will allow greater operational flexibility for NTM stabilization. A new pellet injector for elm pacing, capable of operating at 150 Hz is also planned.

Looking farther ahead, there are plans to install a resistive shell for passive stabilization of resistive wall modes along with a set of 24 actively driven coils. These would be used for control of external kink modes in reversed shear scenarios in experiments in the 2009/2010 time frame. Capabilities for external current drive will be improved. The methods available on AUG today, NBI and ECCD are limited in either spatial localization, efficiency for off-axis drive or overall power available. A lower hybrid system is being considered for installation by 2010.

### References

- [3.b.1.1] Gruber et al., "Overview of ASDEX Upgrade Results", IAEA Chengdu, 2006
  - [3.b.1.2] Mertens, et al, Recent accomplishment and future plans of ASDEX Upgrade",
  - [3.b.1.3] Proceedings of 21st IEEE/NPS symposium on Fusion Engineering (SOFE), 2005
- AUG team, Special Issue, FS&T 44 569-748 2003

### 3.b.2. C-Mod

#### Mission/Program

Alcator C-Mod, located at the Massachusetts Institute of Technology in Cambridge, MA, is a compact, high-field tokamak with metal plasma-facing components (PFC) and RF systems for heating and current drive. There are three basic components to the machines mission: 1) support the ITER inductive H-mode baseline scenario; 2) investigate advanced scenarios with high bootstrap fraction in quasi-steady state; 3) conduct research into the underlying topical science areas of transport, plasma boundary, wave-particle interactions and macrostability. Since C-Mod can operate at the same toroidal field and plasma density as ITER and with similar ICRF and LH frequencies, the plasma

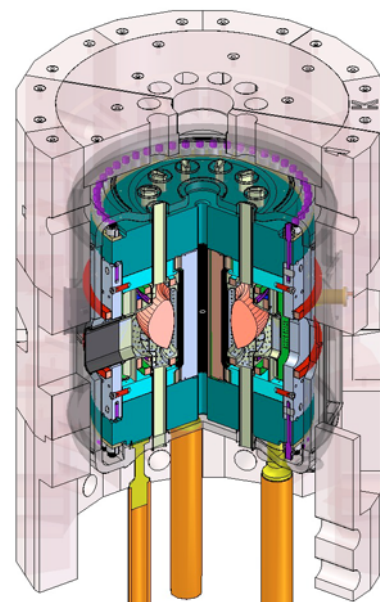

*Alcator C-Mod Tokamak*

## Draft FESAC sub-panel report – Do not circulate

dielectric properties are nearly identical, making these experiments particularly relevant. The AT experiments feature equilibrated current profiles, heating and current drive systems without associated momentum or particle sources and equilibrated ion and electrons. The unique dimensional parameters broaden inter-machine comparisons and comparisons between theory, simulations and experiments.

Lined with over 7,000 molybdenum tiles, C-Mod is currently the only divertor tokamak operating with all metal PFCs. A set of tungsten divertor tiles, with an ITER-like design, has been recently installed and increased use of tungsten in the future is under consideration. Plasma wall interactions and retention of hydrogenic species in metal PFCs is an active area of research as are studies of erosion, deposition and dust generation. Power and particle fluxes are similar to those expected on ITER, though with much shorter discharge lengths. Because of its high-density operation, C-Mod runs with higher neutral and photon opacity, enabling studies of neutral viscosity and radiation transfer in regimes that approach those expected for ITER. A recently installed cryopump should allow operation over a wider range of collisionalities and increase the overlap with lower-field devices.

C-Mod has a broad program in turbulence and transport including studies of energy, particle and momentum transport channels. Investigations of self-generated rotation and momentum transport are motivated by the need to predict plasma rotation in future reactors with low or zero external torque and low  $\rho^*$ . Similarly, particle transport experiments are part of a coordinated international program aimed at predicting density profiles at low collisionality and suggest that ITER could expect moderately peaked density profiles even in the absence of a core particle source. The LHCD will enable direct manipulation of steady-state magnetic shear on C-Mod and allow tests of drift-wave simulations which predict a significant dependence on this parameter. High-k fluctuation diagnostics will be employed to look for the origins of electron energy transport. Studies of H-mode threshold emphasize local physics, especially the role of SOL flows and SOL/edge coupling. As noted above, the unique dimensional regime of C-Mod, in combination with other machines enables investigation into H-mode pedestal scaling over a wide range of parameters and allows evaluation of role of plasma physics (scaling like  $n_e a^2$ ) and atomic processes (scaling like  $n_e a$ ).

Characterization, prediction and mitigation of disruptions is an area of focus in the MHD area. Early experiments have shown promising results in radiating a substantial fraction of discharge energy, decreasing the current quench time and reducing halo currents following a disruption. Experiments into mode locking thresholds are carried out in coordination with other devices in order to predict the maximum error field allowable for ITER, which will be critical during the low-density start-up phase of each discharge. Studies of intermediate  $n$  Alfvénic Eigenmodes are carried out using a set of active MHD coils which can characterize growth rates for stable and unstable modes. Research into H-mode pedestal stability has emphasized small and no-ELM regimes and comparisons with peeling-ballooning models.

## Draft FESAC sub-panel report – Do not circulate

With only RF systems for heating and current drive, the C-Mod program makes substantial efforts to understand the physics and technology of these systems, aiming to increase their launched power density and overall effectiveness. These efforts include an active program to model and characterize ICRF antennas and LH launching structures. Currently under test are fast ferrite tuners which will allow real-time matching for the ICRF systems. Another area of research is the generation of impurities enhanced by RF sheaths which is particularly critical in metal walled machines - The current ITER first wall design has tungsten tiles connected, along magnetic field lines, directly to its ICRF antenna. The LH systems are designed for the efficient off-axis current drive needed for the AT program, motivating extensive studies of wave coupling and spectrum optimization. In collaboration with the RF SciDAC group, there is a significant effort to validate RF models by detailed measurements of RF waves in the plasma, modification of the particle distribution functions and local perturbations of temperature and current profiles.

### Alcator C-Mod Parameters & Capabilities

$$B_T = 2.4 - 8.0 \text{ T}$$

$$I_p = 0.2 - 2.0 \text{ MA}$$

$$R = 0.67, a = 0.22 \text{ m}$$

$$\kappa = 0.9 - 1.85, \delta = 0 - 0.8$$

$$P_{\text{ICRF}} = 6 \text{ MW @ } 40\text{-}80 \text{ MHz}$$

$$P_{\text{LH}} = 3 \text{ MW @ } 4.6 \text{ GHz}$$

All metal PFC (Mo, W)

Pulse length to 5 sec ( $\sim \tau_{L/R}$ )

### Schedule/Plans

C-Mod is currently in the fourth year of its five-year program and is preparing the next five-year proposal, which covers operations beginning FY 09. Proposed upgrades will include, additional LHCD power with a second launcher to allow experiments with multiple wave numbers; a new 4 strap ICRF antenna and upgrades to the transmitter and matching networks; a polarimetry diagnostic for measuring the current profile in the plasma core; and general upgrades to the diagnostic set.

### 3.b.3. DIII-D

DIII-D is a medium sized tokamak located at General Atomics in La Jolla, Ca.

**Mission:** To establish the scientific basis for the optimization of the tokamak approach to fusion energy production. The DIII-D Program is an integrated science program aimed at an energy goal. The three main program elements and objectives are

1. ITER support: Enable the success of ITER by providing physics solution to key issues.

## Draft FESAC sub-panel report – Do not circulate

2. Advanced Tokamak: Establish the physics basis for steady-state high performance operation for ITER and beyond.
3. Science: Play a lead role in advancing fundamental understanding of fusion plasmas on a broad front.

In order to effectively meet the objectives of these program elements, the DIII-D experimental effort is organized into five research areas:

Steady-State Integration – The long-range goal is to demonstrate high-performance inductive and non-inductive advanced tokamak ( $\beta_N > 4$ ) operational scenarios, including not only core plasma scenario development, but also integration of solutions for handling the heat and particle fluxes at the boundary, operational control and machine protection techniques, and credible start-up and normal shutdown scenarios for these high-performance discharges. Research on these topics will benefit from planned upgrades to the ECH, NBI, and FW systems that will increase total heating power to 30MW, enabling higher  $\beta_N$  and  $T_e/T_i$ , while improving overall current profile control capability. Improved feedback control-coil systems, off-axis NBI, and extended TF pulse lengths will provide additional flexibility to extend and optimize advanced scenarios.

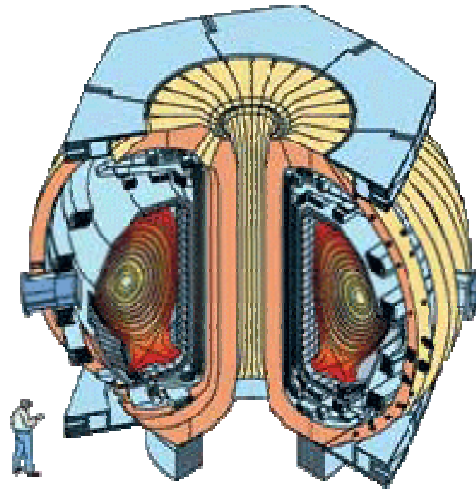

*The DIII-D Tokamak*

ITER Physics – The operating flexibility of DIII-D allows it to address a broad range of scientific and technical issues of direct relevance to ITER construction and operation, and to do so in a timely and efficient manner in conjunction with other fusion research tokamaks. This research is a critical part of preparation for the operation of ITER. The issues selected for emphasis in 2007-2009 include: 1) Suppression and control of edge localized modes (ELMs) through resonant magnetic perturbations, pellet pace-making, and QH-mode studies; 2) Resistive wall mode control using feedback control coils and taking advantage of rotation control with co/counter neutral beam injection; 3) NTM control using modulated and steady-state ECCD; 4) Disruption characterization and mitigation using massive gas puffing; 5) Tritium inventory control studies using surface analysis,  $^{13}\text{C}$  injection, DiMES, and surface conditioning (e.g. oxygen bake). –Over the longer term, we expect to shift emphasis to preparing for ITER operation.

Fusion Science – This research area conducts experiments to understand the underlying physical processes governing five topical areas. In the Boundary area, research addresses radial heat transport, limits to energy dissipation by radiation and other processes, the physics of surface erosion and impurity migration, edge flows, and the stability and transport of the edge pedestal. Energetic particle research seeks to understand the role of Alfvén eigenmodes on fast-ion transport and the role of fast ions in sawtooth stability. In

## Draft FESAC sub-panel report – Do not circulate

the heating and current drive area, the emphasis is on developing the scientific basis for comprehensive models for NBCD, ECCD, and FWCD, with a near-term focus on fast-ion coupling effects and understanding bootstrap current in the edge pedestal region. Stability research is focused on understanding error-field effects (correction and plasma screening) using co/counter NBI to vary plasma rotation. Transport research is facilitated by a comprehensive set of turbulence diagnostics with a focus on understanding intrinsic rotation and high-k turbulence, seeking to understand electron transport.

### *Present and planned capabilities for DIII-D.*

Quantity	Present Capability	FY2009 Capability	FY2013 Capability*
Toroidal Field	2.1 Tesla for 4.5s	2.1 Tesla for 10s	2.1 Tesla for 10s
Plasma Current (MA)	1.3MA – 10s 3.0MA – 2s	1.3MA – 10s 3.0MA – 2s	2MA – 10s 3.0MA – 3s
Configuration	+/- I <sub>p</sub> & +/- B <sub>T</sub> USN, LSN, DN, IWL	+/- I <sub>p</sub> & +/- B <sub>T</sub> USN, LSN, DN, IWL	+/- I <sub>p</sub> & +/- B <sub>T</sub> USN, LSN, DN, IWL
Feedback control coils (RWM and ELM control)	12 internal 6 external	12 internal 6 external	18 internal 6 external
Neutral Beam Injection Co Counter Off-axis capable <sup>†</sup>	12.5MW – 3s 5 MW – s	15 MW – 3s 5 MW – 3s	15 MW – 3s 5 MW – 3s 10 MW – 3s
RF H & CD (MW)	3 MW – 2s	5 MW – 2s	6MW – 10s
EC Heating and Current Drive (MW)	3.8MW – 5s, steerable launch	5.8MW – 10s steerable launch	12MW – 10s, <i>fast</i> steerable launch
Energy Throughput	200MJ	200MJ	300MJ
Plasma Facing Surfaces	Graphite	Graphite	Graphite
Divertor Pumping	90 m <sup>3</sup> /sec	90 m <sup>3</sup> /sec	90 m <sup>3</sup> /sec
Diagnostic Systems/ Data Acquisition	~1200 channels 4 GB/shot	~1400 channels 7 GB/shot	~1600 channels 15 GB/shot

\* Planned for inclusion in FY2009–2013 Program Plan Proposal. <sup>†</sup> Two co-current beam lines reoriented for off-axis injection for specific experiments. 20MW total NBI capability.

Integrated Modeling – Research here is directed towards validating theoretical models through experimental tests to enable implementation of interpretive and predictive codes for DIII-D and other tokamaks. This requires effective data analysis tools for both experiment and simulation (e.g. synthetic diagnostics). The GYRO transport code is compared directly with experiments, but is expensive to run, thus motivating development and implementation of the TGLF transport model. The NIMROD 3D resistive MHD code is simulating ELM control by resonant magnetic perturbations and

## Draft FESAC sub-panel report – Do not circulate

gas-puff disruption mitigation. ELM control and pedestal stability experiments are examined using the ELITE code, while the BOUT code is being compared against edge turbulence measurements. Finally, the UEDGE, DIVIMP, and OEDGE codes are being compared against scrape-off-layer and divertor data to better understand particle and energy flows in the plasma boundary.

Plasma Control and Operations – Work in this area is directed towards development of plasma control tools for DIII-D and other tokamaks to enable reliable high performance operation for fusion research. Activities follow an integrated approach to control design: producing validated plasma response models, developing design simulation tools, controller designs, and testing integrated control solutions for plasma shape, position, stability, and internal plasma profiles (e.g. current, pressure, and rotation). As much as possible, these control designs are derived from physics-based models in order to maximize transferability of solutions to ITER and other next-generation devices. Research in this area also supports the development and use of specialized versions of the DIII-D Plasma Control System (PCS) at devices under construction and in operation worldwide, including KSTAR, EAST, NSTX, MAST, and PEGASUS.

### **Capabilities and Upgrade Schedule:**

The table below shows present and planned major device capability for the DIII-D facility. The DIII-D program is now preparing a new Five Year Program Plan for FY 2009-20013. Major upgrades are planned for the ECH system (increased heating power and fast steering), the Fast Wave system (improved high power long pulse antennas), and the neutral beams (longer pulses and capability for 10MW of off-axis injection. Improvements to coil systems will increase full-field TF pulse lengths to 10s and further reduce error fields. We plan to expand the set of internal coils (and improve their power supplies) for ELM-control and RWM research. Expansion of the diagnostics capability will continue across many areas.

**References:** <http://web.gat.com/global/Home>.

### **3.b.4. EAST**

#### **Mission/Program**

EAST is a new superconducting tokamak device at the Institute of Plasma Physics, Hefei, China. Its mission is to investigate the physics and technology in support of ITER and steady-state advanced tokamak concepts. Shaped hydrogen/deuterium plasmas with both single-null and double-null divertor configurations will be possible.

The device features all superconducting magnets, actively cooled plasma facing



*The EAST Tokamak*



## Draft FESAC sub-panel report – Do not circulate

components, flexible shaping capability, and good access for changing the plasma facing components and other internal structures. The heating and current drive systems are expected to provide flexible current and pressure profile control. The program has a large emphasis on developing steady-state diagnostics which not only protect device operation but also provide a broad range of measurements in support of the long-pulse physics mission.

The EAST mission in support of ITER will emphasize plasma control. Strategies will be developed for equilibrium, shape, and position control in an all-super-conducting magnet environment. Fast-response internal feedback coils will be available to develop real-time, long-term control. A flexible set of heating and current drive systems will permit current profile control. Experiments on disruption mitigation by gas and/or pellet injection experiments are planned. A high performance hybrid mode (partial inductive current drive) at full toroidal field and current can be sustained for 30 s. Physics goals include high performance H-mode operation, and divertor optimization (e.g., developing divertor concepts compatible with high triangularity and high beta, testing various plasma facing components and active cooling, and developing long-term particle exhaust). Expected plasma parameters include  $T_e > 5 \text{ keV}$  and  $n_e > 5 \times 10^{19}$ .

The EAST mission in support of advanced tokamak concepts will highlight the long-pulse device capability and momentum-free heating sources. A full non-inductive scenario with high beta  $\beta_N > 4$  and bootstrap fraction approaching 90% is possible at  $I_p = 0.5 \text{ MA}$  for 60 s pulses. Somewhat lower  $\beta_N > 3$  shorter pulse plasmas are possible at higher  $I_p$ . Divertor optimization for the advanced tokamak will be emphasized, as well as development and testing of advanced plasma facing components and wall conditioning techniques.

### **EAST Parameters & Capabilities**

$B = 3.5 \text{ T}$

$I_p = 1.0 \text{ MA}$

$R = 1.9 \text{ m}$

$a = 0.45 \text{ m}$

$\kappa = 1.2\text{-}1.7$

$\delta = 0.2\text{-}0.7$

$P_{\text{ICRH}} 4.5 \text{ MW @ } 30\text{-}110 \text{ MHz} / 4.5 \text{ MW @ } 20\text{-}50 \text{ MHz}$

$P_{\text{LHCD}} 2 \text{ MW @ } 2.45 \text{ GHz} / 4 \text{ MW @ } 3.7 \text{ GHz} / 4 \text{ MW @ } 4.6 \text{ GHz}$

$P_{\text{ECRH}} 0.5 \text{ MW}$

Pulse duration 10-100 s

### **Schedule/Plans**

First plasmas were formed in late 2006. A two phase operation schedule is planned. During the first phase 2007-2009, the field and current will be increased to 3.5 T and 1 MA. A substantial fraction of the eventual heating and current drive power will be available. The full heating and current drive will be available in the second phase 2010-2011. An internal cryo-pump will also be available to enable extending the pulse length 10-100 s. There is also a plan for 5 MW of neutral beam injection late in the second

phase. Beyond the second phase, smaller major plasmas  $R=1.7$  m are planned to reduce the impact of toroidal field ripple.

### References

[3.b.4.1] J. Li, “EAST 5 year physics plan”, presentation at 2nd EAST International Advisory Committee Meeting, Oct. 13-14, 2006, Hefei, China.

[3.b.4.2] Wan et al, OV/1-1, 21<sup>st</sup> IAEA Fusion Energy Conference, Chengdu, China, 2006.

### 3.b.5.. FTU

#### Mission/Program

FTU is a compact high-field limiter tokamak with circular cross section located at the Centro Ricerche Energia in Frascati, Italy. It tends to run at higher density (and collisionality) than most other machines in the world program. As a result electrons and ions tend to be equilibrated in most operating regimes. Pellet injection has been applied to extend operation to higher densities. Auxiliary heating is by RF, with power available in the ion cyclotron, lower hybrid and electron cyclotron ranges of frequency.

The aim of the lower hybrid current drive program is to extend the range of this technique to higher densities. High efficiency has been obtained at densities approaching  $10^{20}/\text{m}^3$ . Parametric decay and other parasitic losses were apparently not a problem, though one notes that coupling issues are likely to be different when comparing limiter L-mode results to that with divertor H-modes. Tests have been conducted to qualify a possible ITER design for a LHCD launcher - the Passive-Active Multijunction (PAM). This approach, while producing a less favorable wavenumber spectrum, should allow space for active cooling and neutron shielding that would be required on ITER, CTF or Demo.

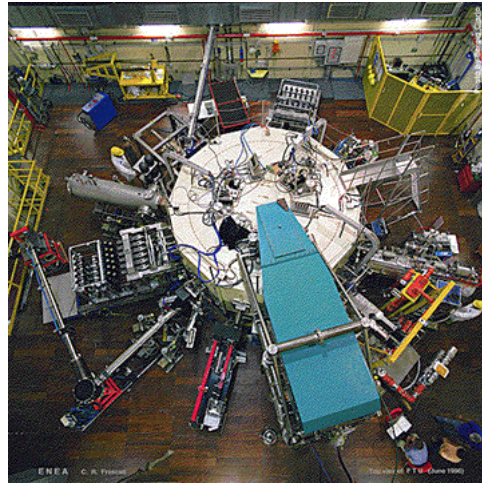

*The Frascati Tokamak Upgrade*

ECRF has been used for localized heating, production of internal transport barriers and studies of electron thermal transport. Internal barriers to electron transport have been produced by strong electron heating, especially during the current rise phase. In these cases, the barrier can be sustained by application of off-axis LHCD. These experiments are carried out without a central particle or momentum source.

Ion Bernstein Waves (IBW) have been used for ion heating studies and for exploration of RF flow drive. So far some improvement in energy confinement has been observed.

## Draft FESAC sub-panel report – Do not circulate

This work has not been definitive, but the technique offers an opportunity for control of the pressure profile by direct intervention in the turbulence dynamics.

FTU has begun tests of liquid wall concepts by installing a capillary fed lithium limiter. Thermal loads and sputtering raise the surface temperature and generate a significant quantity of gaseous lithium which subsequently coats the vessel walls. The resultant plasmas are somewhat cleaner, have higher SOL temperatures and can operate at higher density with peaked density profiles. Overall, the dynamics of this coating are similar to other wall conditioning and coating techniques. The applicability to continuous operation are not clear, however these experiments are an important demonstration of the use of lithium in a high performance tokamak.

### FTU Parameters & Capabilities

$R = 0.93 \text{ m}$

$a = 0.30$

Plasma cross section: circular

$B_T = 8 \text{ T}$

$I_p = 1.6 \text{ MA}$

$P_{LH} = 2.5 \text{ MW @ } 8 \text{ GHz}$

$P_{ECRH} = 1.2 \text{ MW @ } 140 \text{ GHz}$

$P_{IBW} = 0.5 \text{ MW @ } 433 \text{ MHz}$

Metal walls with experimental Li limiter

### Schedule

Plans include, upgrades to the ECRH systems to allow higher power and installation of 1 MW ICRH at 80 MHz for ion heating and studies of energetic ions.

### References

[3.b.5.1] Pericoli-Ridolfini et al., “Overview of FTU results” IAEA, Chengdu 2006

[3.b.5.2] Angelini, et al., “Overview of FTU results” IAEA Villamora 2004

[3.b.5.3] FTU team, Special Issue, Fusion Science and Technology, 45 pg 297-520 2004

### 3.b.6. Helically Symmetric Experiment (HSX)

The Helically Symmetric Experiment (HSX) [3.b.6.1] is a moderate size ( $R = 1 \text{ m}$ ,  $a = 0.12 \text{ m}$ ,  $B = 1 \text{ T}$ ) stellarator device at the University of Wisconsin that began operating in 1999. It is the first (and presently only operating) stellarator built with a quasi-symmetric magnetic configuration; in the case of HSX, the

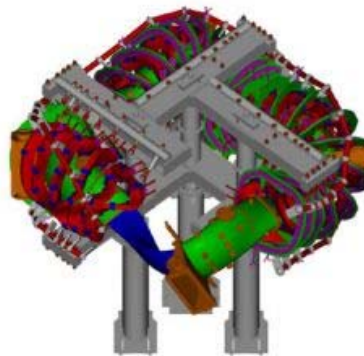

Cutaway drawing of the HSX stellarator.

direction of quasi-symmetry is helical. HSX has four field periods, which with the helical quasi-symmetry give the machine a square appearance. The low-shear rotational transform profile can be varied above and below unity, and the degree of quasi-symmetry, the magnetic well, and helical ripple profiles can be adjusted by varying the ratio of currents in the several different types of modular and planar (toroidal field) coils. At present, the plasma is heated for  $\sim 50$  ms by 100 kW of ECH at 28 GHz, which at  $B = 1$  T yields plasmas with central electron temperatures  $\sim 2$  keV and ion temperatures  $\leq 100$  eV at densities  $3\text{-}4 \times 10^{18} \text{ m}^{-3}$ . Work is in progress to add another gyrotron to increase the heating power to 200-300 kW. In the longer term, electron Bernstein wave and ion-cyclotron heating will be used to operate at higher density and heat ions.

The HSX experimental program concentrates on fundamental studies of the role of quasi-symmetry in determining plasma flows, particle/energy transport, and fluctuations and turbulence. The flexibility of the configuration—in which quasi-symmetry can be switched on and off—plays a crucial role in the research. Noteworthy results from HSX include the first demonstrations that quasi-symmetry greatly reduces flow damping [3.b.6.2] and cross-field thermal diffusivity [3.b.6.3]. Work is in progress to measure electric fields (using beam emission spectroscopy and heavy-ion beam probing) as well as core and edge turbulence and correlate these with local transport in quasi-symmetric and non-symmetric configurations.

### References

- [3.b.6.1] F. S. B. Anderson et al, Fusion Technology **27**, 273 (1995).
- [3.b.6.2] S. P. Gerhardt et al, Phys. Rev. Lett. **94**, 015002 (2005).
- [3.b.6.3] J. M. Canik et al, Phys. Rev. Lett. **98**, 085002 (2007).

### 3.b.7. JET (EU)

The Joint European Torus which is under the European Fusion Development Agreement (EFDA), is located at the Culham Science Centre, in Abingdon, United Kingdom. It is the largest tokamak currently in operation in the world. It has as its primary mission element the support of the ITER program. The summary presented here was taken largely from [3.b.7.1]. The JET device has replaced the divertor to permit high triangularity operation. This enables making plasmas very like the planned ITER boundary shape. In addition, a plan is in place to replace the inner wall and divertor materials to mimic the phase 1 ITER wall/divertor (Beryllium first wall, Tungsten and Carbon divertor) and planned phase 2 wall/divertor (Beryllium first wall, all Tungsten divertor). JET plans to investigate tritium retention with these new wall/divertor systems and to test in-situ

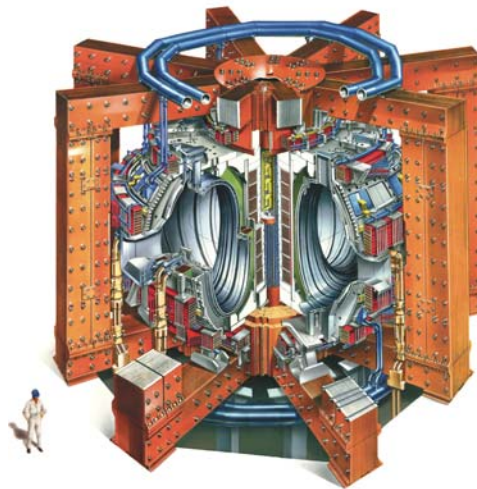

*The JET device*

detritiation systems as well as the issues associated with mixed Be-W layers. JET also plans to upgrade the maximum available NBI heating power to 34 MW for 20s (currently 25MW 10s), with a long pulse (40s) capability of 17MW (total heating power 25MW). A new ITER-like ICRH antenna will also be installed with 10s capability. The long pulse heating capability will be used to investigate scenarios similar to the Q=5 steady state scenario envisioned for ITER. A high frequency pellet injector (60Hz) will be installed for ELM pacing studies as a follow on to similar studies on the ASDEX-U device. The injector has unlimited number of pellets (continuous screw feed). Diagnostic enhancements for determining the effectiveness of the pacing are also planned.

### JET Parameters & Capabilities

$$R = 3 \text{ m}$$

$$a = 1.2 \text{ m}$$

$$B_T = 4 \text{ T}$$

$$I_p = 7 \text{ MA}$$

$$T_i = 40 \text{ keV}$$

$$P_{\text{Heating}} = 50 \text{ MW from all sources}$$

$$P_{\text{Fusion}} = 16 \text{ MW}$$

$$W_{\text{Fusion}} = 22 \text{ MJ}$$

$$Q_{DT} = 0.6$$

[3.b.7.1] J. Pamela, et al., “The JET Programme in Support of ITER”, EFDA-JET-CP(06)04-19 available at <http://www.iop.org/Jet/fulltext/EFDC060419.pdf>

### 3.b.8. JT60-SA

#### Mission/Program

The JT-60SA (“Super Advanced”) is a large, breakeven-class, superconducting magnet tokamak proposed to replace the JT-60U device at Naka, Japan. It will operate only with hydrogen and deuterium. There are two main mission elements: (1) support and extension of ITER-like operating scenarios and (2) development of steady-state, non-inductive operating regimes at high beta  $\beta_N=3.5-5.5$ . Pulse lengths of 100 s at full 41 MW auxiliary power and 8 hr at reduced power are specified. The construction of JT-60SA will be under the “Broader Approach” agreement between Japan and the European Union.

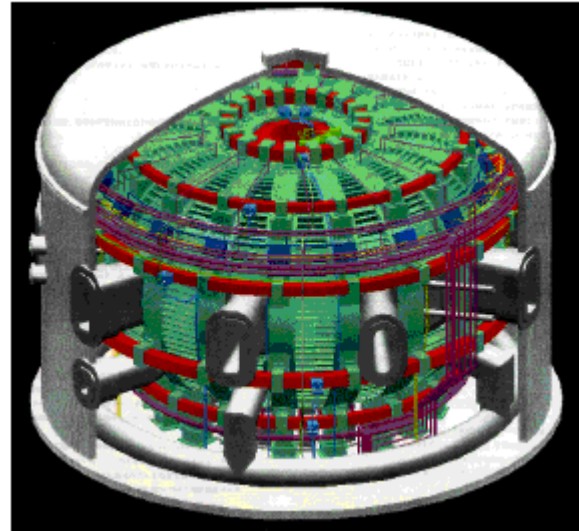

JT60-SA

## Draft FESAC sub-panel report – Do not circulate

The device is designed to produce ITER-shaped plasmas at about one-half scale. Flexible heating and current drive systems will permit a variety of experiments in support of ITER. The combination of negative-ion neutral beam heating and ECRH will permit plasmas with dominant electron heating having a significant energetic particle population. Equal amounts (4 MW each) of co- and counter-tangential positive ion neutral beam heating will enable plasma rotation control. A large amount (16 MW) of perpendicular injection neutral beam heating will allow plasma pressure control without large current or momentum drive, which enables simulation of burn control in ITER. The total heating power of 41 MW will also permit accessing H-mode at high density. The divertor heat load and particle fluxes will also be close to ITER values.

The device is also designed to explore high beta, fully non-inductive configurations beyond ITER capability by enhancing flexibility in the aspect ratio and plasma shape. The upper and lower divertors will be designed differently to permit forming both high and low triangularity single-null divertor configurations. Double-null divertor configurations are also possible. Strongly shaped, lower aspect ratio  $A=2.6$  configurations with high beta limits are designed to investigate advanced non-inductive scenarios with bootstrap current fraction up to 0.7. Passive stabilizing plates and active feedback coils are planned to control  $n=1,2$  resistive wall modes. The shaping and auxiliary heating systems are being designed to permit a range of current profiles with positive to negative magnetic shear.

A comprehensive diagnostic set is planned, most available with the initial operation of the device. This set includes critical profile measurements vital to understanding advanced tokamak scenarios.

### **JT60-SA Parameters & Capabilities**

$B = 2.72/2.59$  T\*

$I_p = 5.5/3.5$  MA\*

$R = 3.01/3.16$  m\*

$a = 1.14/1.02$  m\*

$\kappa_{95} = 1.83/1.7$ \*

$\delta_{95} = 0.57/0.33$ \*

$P_{\text{NBI}}$  (perp./co-/counter-) 16/4/4 MW @ 85 keV

$P_{\text{NBI}}$  (neg. ion, co-) 10 MW @ 500 keV

$P_{\text{ECRH}}$  3 MW @ 110 GHz and 4 MW @ 140 GHz

$q_{\text{heat}} \leq 10$  MW/m<sup>2</sup>

Pulse duration 100 s (8 hr)

\*B,  $I_p$ , size, and shape parameters specified for advanced non-inductive/ITER-shaped options.

### **Schedule/Plans**

The construction of JT-60SA is planned to take 7 years, with first plasmas in 2014. The Broad Agreement (BA) is 10 years, so the first 3 years of operation would be conducted jointly by Japan and the European Union under BA.

### References

- [3.b.8.1] Kikuchi et al, EX/P4-3, 21<sup>st</sup> IAEA Fusion Energy Conference, Chengdu, China, 2006.
- [3.b.8.2] Fujita et al, FT/P7-4, 21<sup>st</sup> IAEA Fusion Energy Conference, Chengdu, China, 2006.

### 3.b.9. KSTAR

#### Mission/Program

KSTAR is a new, recently commissioned superconducting magnet tokamak at Daejeon, Korea. It will operate with hydrogen and deuterium. The main research objective of KSTAR is to demonstrate steady-state high-performance advanced tokamak scenarios. The device has flexible shaping capability with a complement of heating and current drive tools that will permit study of a wide range of scenarios in both single and double null divertor configurations. The development of advanced scenarios will progress in steps, which are described in detail in the schedule and plans section below.

KSTAR has significant capability for ITER-relevant physics and engineering research, summarized in Table 1. Optimization of ITER operating scenarios, MHD control, and plasma-wall interaction are of interest in ITER-like plasma configurations, exploiting the in-vessel control coil system and KSTAR's long-pulse capability. For engineering, KSTAR employs ITER-like magnet coils using Nb<sub>3</sub>Sn superconductor. Thus, KSTAR can be utilized as a test bed for developing and maintaining ITER-like magnets, examining issues such as AC loss and quench characteristics of Nb<sub>3</sub>Sn superconducting coils. KSTAR is also going to implement ITER-like heating and current drive systems, such as 170 GHz EC and 5 GHz LH systems to provide an operational knowledge base prior to ITER. KSTAR will operate as an international fusion collaboratory, which will provide practical experience for the methods that will need to be employed for ITER. The total number of pulses at full pulse length in highest performance operation will likely be limited by neutron activation from D-D and daughter D-T reactions.

#### KSTAR Parameters & Capabilities

B = 3.5 T

I<sub>p</sub> = 2.0 MA

R = 1.8 m

a = 0.5 m

κ<sub>95</sub> = 2

δ<sub>95</sub> = 0.8

P<sub>NBI</sub> 8 MW @ 120 keV (upgrade planned to 24 MW)

P<sub>ICRF</sub> 6 MW @ 30-60 MHz (upgrade planned to 12 MW)

P<sub>LHCD</sub> 1.5 MW @ 5 GHz

P<sub>ECH/ECCD</sub> @ 170 GHz (power to be specified)

Pulse duration 300 s

**Schedule/Plans**

The schedule for major steps in the KSTAR program is illustrated in Fig. 1 below. The initial operation phase (2008-2012) will establish the basic operation of a superconducting tokamak through the Ohmic, L-, and H-mode plasma experiments in the relatively short pulse-length regime of a few tens of seconds. Plasma facing components, such as limiter, divertor, and passive plates will be installed for the double-null D-shape plasma formation. In-vessel control coil system will be also installed for multi-purpose plasma control of plasma position, field errors, ELM, resistive wall mode, etc. The second phase (2013-2017) will concentrate mainly on developing the steady-state operation of a superconducting tokamak at relatively low power (~10MW) and low beta ( $\beta_N \sim 2-3$ ) regime. Experiments in standard H-mode and Hybrid mode will be carried out to increase the pulse length from a few tens to 100-300 sec utilizing non-inductive current drive systems. The development and optimization of long-pulse capability for the divertor system (e.g., particle and impurity control) and of real-time MHD control (ELM, NTM modes etc.) will pursue in parallel. Utilization of KSTAR as an ITER pilot-device for the test and optimization of ITER-relevant physics and engineering issues will be emphasized during this period.

*Table 1. ITER-relevant research subjects which can be addressed using KSTAR*

	ITER-relevant research subjects
Operation scenario	<ul style="list-style-type: none"> <li>- ITER-like operation scenario, such as H, Hybrid, steady-state modes</li> <li>- Low loop-voltage start-up using ECH pre-ionization</li> <li>- RF discharge cleaning etc.</li> </ul>
MHD control	<ul style="list-style-type: none"> <li>- Plasma shape control in the ITER-like plasma configuration</li> <li>- Field error, RWM, ELM control using in-vessel control coil</li> <li>- Real-time NTM control using ECCD</li> <li>- Disruption mitigation and control</li> </ul>
Plasma-wall interaction	<ul style="list-style-type: none"> <li>- Test of ITER-like PFC materials</li> <li>- Long-pulse operation of divertor system in ITER-like heat flux condition</li> <li>- Particle and impurity control in long-pulse operation condition</li> </ul>
Superconducting coil system	<ul style="list-style-type: none"> <li>- Test of AC-loss, quench characteristics of Nb<sub>3</sub>Sn superconducting coil</li> <li>- Disruption effect on superconducting coil system</li> </ul>
Ancillary systems	<ul style="list-style-type: none"> <li>- ITER-like heating &amp; CD system: 170GHz ECH/ECCD, 5GHz LHCD</li> <li>- Diagnostic system in the long-pulse operation condition</li> </ul>
Control and remote collaboration	<ul style="list-style-type: none"> <li>- Real-time data analysis and control</li> <li>- Remote experiment and control using fusion grid</li> <li>- Machine operation as an international collaboratory</li> </ul>

The study of high-beta AT mode and its long pulse operation will be carried out intensively during the third (2018-2022) and fourth (2023-2025) phases. The AT mode study will start from a relatively low power (~ 16MW) regime, and then be upgraded to



## Draft FESAC sub-panel report – Do not circulate

the full power ( $\sim 28\text{MW}$ ) regime. Final target values of the AT mode are  $\beta_N \sim 4-5$  and  $f_{BS} \sim 0.8-0.9$  with  $B_T \sim 3.0-3.5\text{T}$  and  $I_p \sim 1.5-2\text{MA}$ . Off-axis LHCD and nearly-balanced NBI systems for reverse-shear q-profile formation will be employed. In-vessel control coils and plasma flow will be employed for RWM control in high beta advanced tokamak scenarios with reactor-relevant conditions of low rotation and  $T_i \sim T_e$ .

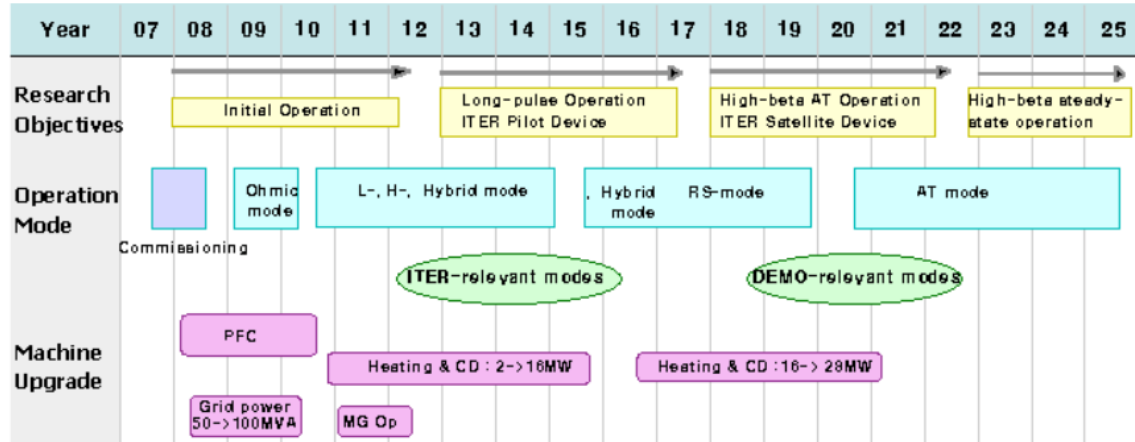

Figure 1. Overall Operation and Research Plan for KSTAR

### References

- [3.b.9.1] A summary provided by the KSTAR team at the panel's request.
- [3.b.9.2] H.L. Yang et al, FT/2-2, 21<sup>st</sup> IAEA Fusion Energy Conference, Cheng du, China, 2006.
- [3.b.9.3] J-G Kwak et al, FT/P7-2, 21<sup>st</sup> IAEA Fusion Energy Conference, Cheng du, China, 2006.

### 3.b.10. Large Helical Device (LHD)

LHD [3.b.10.1] is a large ( $R = 3.9\text{ m}$ ,  $a = 0.6\text{ m}$ ,  $B = 3\text{ T}$ ) superconducting stellarator device that began operating in 1998 at the National Institute of Fusion Science, Toki, Japan. Its magnetic configuration is referred to as either a heliotron or a torsatron, and consists of  $l = 2$  helical windings carrying current in one direction with 10 field periods around the torus, plus an array of poloidal field coils which cancel the net vertical field of the unidirectional helical winding currents and also provide poloidal field shaping and variation of the rotational transform  $\iota$  ( $= 1/q$ , where  $q$  is the safety factor). Its rotational transform profile is adjustable in detail, typically with  $\iota(0) \approx 0.2-0.7$

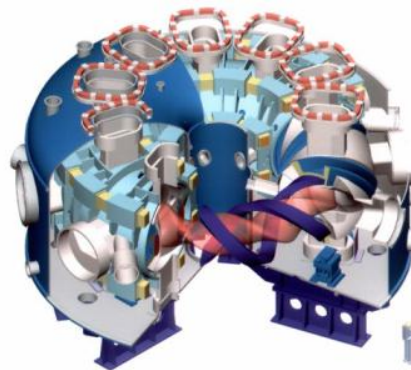

Cutaway drawing of the LHD stellarator

Its rotational transform profile is adjustable in detail, typically with  $\iota(0) \approx 0.2-0.7$

## Draft FESAC sub-panel report – Do not circulate

and  $\iota(a) \approx 1.5$ -1.6, somewhat similar to a reversed tokamak  $q$  profile. It is heated with 18 MW of tangential neutral beam heating (negative ions, 150-180 keV), 4 MW of perpendicular NBI (positive ions, 4 keV), 1 MW of ECH and 3 MW of ICRF. The field structure provides a natural helical divertor which can be exploited with appropriate baffling and pumps. Perturbation coils in each period can be used to induce/adjust magnetic islands to control the divertor configuration in detail.

The results of LHD experiments so far are [3.b.10.2-4]:

- Stable confinement of plasmas with volume averaged  $\beta$  values  $\leq 4.8\%$  for times  $\sim 1.5$  sec  $\sim 10$  energy confinement times.  $\beta=4\%$  has been maintained for  $>40$  energy confinement times. The achievable  $\beta$  is limited by the available heating power, leading to radiative collapse rather than MHD instabilities or disruptions.
- Heating of hydrogen ions to central temperatures  $\sim 5$  keV in plasmas with densities  $\sim 1 \times 10^{19} \text{ m}^{-3}$ ) using a combination of parallel and perpendicular NBI.
- Heating of high  $Z$  argon plasma ions to central temperatures of 13.5 keV using parallel NBI.
- Confinement of high density plasmas (peak densities =  $10^{21} \text{ m}^{-3}$  at  $B = 2.7$  T) sustained with repetitive pellet injection and internal transport barriers. These plasmas have core  $n\tau_E T \approx 4.4 \times 10^{19} \text{ m}^{-3} \text{ s keV}$ .
- Quasi-steady-state operation ( $\leq 54$  minutes) with a combination of ECH, NBI, and ICRF heating (average total power  $\leq 700$  kW, absorbed energy  $\leq 1.6$  GJ).

Planned upgrades for the near term (2009-2012) include:

- Increase of NBI heating power to 32 MW (18MW perpendicular +14MW tangential) for 3 s pulses.
- Increase of ICRF heating power to 3 MW (steady-state).
- Installation of complete, actively-cooled helical divertor.
- Installation of poloidal field power supplies to permit dynamic control and optimization of high- $\beta$  equilibria.
- Deuterium operation.

[3.b.10.1] A. Komori et al, Fusion Sci. Tech. **50**, 136 (2006).

[3.b.10.2] O. Motojima, et al, Nucl. Fusion 47 S668 (2007).

[3.b.10.3] N. Ohyaibu et al, Phys. Rev. Lett. 97, 055002 (2006).

[3.b.10.4] T. Mutoh, Nucl. Fusion 47, 1250 (2007).

### 3.b.11. NCSX

#### Mission/Program

NCSX is a ‘Proof of Principal’ experiment, designed to explore and understand 3D quasi-axisymmetric (QA) shaping to address the plasma physics challenges of enhanced performance steady-state operation without disruptions [3.b.11.1]. NCSX uses 3D shaping to enhance MHD stability without requiring external current drive or feedback systems, producing high-beta plasmas that have the potential to be free of disruptions.

## Draft FESAC sub-panel report – Do not circulate

Due to the quasi-axisymmetry of the 3D shaping, with low remnant effective ripple, the plasma transport properties in NCSX are predicted to be similar to equivalent tokamaks. Thus, NCSX seeks to combine the established features of stellarators (robust stability without feedback control, no disruptions, steady-state without external current-drive, higher density limit) with the excellent transport and compact size of tokamaks.

The NCSX mission is to provide the experimental basis needed to understand and assess the use of 3D QA shaping for controlling high-beta toroidal plasma confinement, and in particular for providing solutions to the physics issues that stand between ITER and DEMO. NCSX will investigate the full breadth of issues for 3D QA shaped plasmas, including  $\beta$  limits and limiting mechanisms, disruptivity, turbulence and confinement, rotation and damping, magnetic surface structure, MHD and fast-ion instabilities, and divertor solutions. This research will be used to test, improve, and ultimately verify theoretical and computational models of plasma confinement with 3D QA shaping, and to develop a common understanding with tokamaks, incorporating the  $\rho^*$ -scaling and burning-plasma understanding from ITER. This understanding will enable assessment of the use of 3D QA shaping for DEMO, including the shaping needed for high  $\beta$  disruption-free operation compatible with steady state sustainment of the magnetic configuration. The significance of 3D QA shaping for fusion energy was recently validated by the ARIES-CS study[3.b.11.2], which projected that a reactor based on a NCSX-like plasma could be competitive with the most optimistic advanced tokamak designs. The improved understanding from NCSX could lead to a reactor similar to ARIES-CS, or to simpler configurations along the continuum between NCSX and the advanced tokamak.

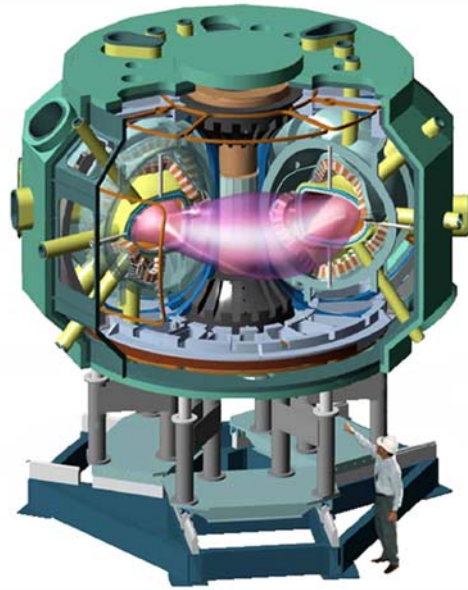

*The NCSX Stellarator*

The NCSX design builds upon the experimental and theoretical understanding of plasma transport and stability from both tokamaks and stellarators, producing a unique set of capabilities. The design was extensively analyzed to ensure that the goals were robustly achieved, were accessible, and that the design had flexibility to explore parametric variations in the theoretically key parameters. The NCSX physics design characteristics include (simultaneously):

- Very good quasi-axisymmetry (low residual ripple), such that the ripple-driven neoclassical thermal transport is negligible 3.b.11. [3] and fast ions are confined. This is calculated to give tokamak-like zonal flows for turbulence suppression [3.b.11.4] and low rotation damping.
- Passive stability at  $\beta = 4.1\%$  to all MHD instabilities that limit beta in tokamaks, including kink, ballooning, vertical, Mercier, and neoclassical-tearing instabilities,

## Draft FESAC sub-panel report – Do not circulate

without the need for feedback stabilization, driven rotation, or nearby conducting walls [3.b.11.5]. The MHD stability threshold can be raised above  $\beta=6.5\%$  by adjusting coil currents.

- Passive disruption stability, in that the magnetic equilibrium is maintained even with a total loss of beta or plasma current.
- ‘Reversed shear’, i.e.  $q$  decreasing or rotational transform increasing across the plasma. This enhances MHD stability, suppresses islands and tearing modes, stabilizes trapped particle instabilities, and reduces turbulent growth rates [3.b.11.6]. The ITG/TEM linear growth rate decreases with increasing beta. In tokamaks, this produces self-stabilization of turbulence and neoclassical ion, particle, and momentum transport.
- 75% of the edge magnetic rotational transform is produced by the coils, 25% by the bootstrap current at  $\beta = 4.1\%$ , with no externally driven plasma current (thus compatible with steady state). This is a substantially lower bootstrap current than advanced tokamaks, significantly reducing the non-linear influence of beta on the equilibrium.
- Very good flux surface quality for high  $\beta$  [3.b.11.7], vacuum, and intermediate  $\beta$ , with less than 3% of the flux lost to islands at  $\beta = 4\%$ .
- Expanded boundary divertor-like edge geometry, independent of the edge rotational transform, due to the strong plasma shaping [3.b.11.8]. The full vacuum system is bakeable to 350C.
- Aspect ratio of 4.4, chosen to be similar to the ARIES-RS tokamak design, and significantly lower than W-7X and LHD. Comparisons across the transport optimized stellarators will provide information to understand the effect of aspect ratio on stellarator confinement.

$\beta = 4.1\%$  was chosen as the design goal because it is substantially above the predicted no-wall stability limit for advanced tokamaks with high bootstrap-current fractions (such as ARIES-RS and ARIES-AT). A stable access path from startup to high-beta has been simulated [3.b.11.9], and the current profile was calculated to be stable to tearing modes [3.b.11.10].

NCSX has been designed as a flexible experiment, allowing a wide variation of the 3D plasma shape and magnetic configuration characteristics by varying the nine external coil currents [3.b.11.11]. This will enable controlled experiments challenging and validating our understanding. For example,

- The degree of QA or effective ripple can be continuously varied at least a factor of 30.
- The coil-produced magnetic rotational transform and shear
- The MHD kink stability threshold can be reduced down to  $\beta \sim 1\%$  at either constant rotational transform or constant edge shear.

This flexibility is obtained using auxiliary coil sets that can be eliminated to simplify future energy systems.

The magnetic field strength can be varied up to 2 T, giving access to higher temperature, lower collisionality plasmas. With 6MW of heating, ion temperatures above 4 keV and  $v_i^* \sim 0.04$  are predicted. This enables experimental study of the confinement scaling with

## Draft FESAC sub-panel report – Do not circulate

normalized gyroradius ( $\rho^*$ ) separated from the collisionality ( $\nu^*$ ) and  $\beta$  scalings, for comparison with theoretical transport models and projections to future devices. This should also allow NCSX to overlap the dimensionless parameter regimes of middle-scale tokamaks. This capability is important for testing the connection between NCSX and tokamak transport understanding.

### NCSX Parameters & Capabilities

$B_T = 1.2 - 2. T$

$R = 1.42 \text{ m}$ ,  $\langle a \rangle = 0.32 \text{ m}$

$\langle \kappa \rangle = 1.8$ ,  $\langle \delta \rangle = 1$ .

Coil produced rotational transform  $\iota = 0.2 - 0.8$

$I_P = 0.320 \text{ MA}$  (maximum)

$P_{\text{NBI}} = 6 \text{ MW}$

$P_{\text{ICRF}}$  up to 6 MW

$P_{\text{ECH}}$  up to 3 MW

Metal, carbon, or Li plasma facing components

Pulse length  $> 1.7 \text{ sec}$  at 1.2T ( $\sim 10\tau_{\text{CR}}$ )

### Schedule/Plans

NCSX is under construction and is scheduled to have first plasma in 2012. NCSX can accommodate up to 12 MW of external heating (NBI, ECH, ICRF) [3.b.11.12] and a comprehensive set of plasma diagnostics. The early experiments will emphasize neutral beam heating to provide access to high beta. The heating systems will be refurbished and reused from previous experiments. The diagnostics and heating systems will be installed and upgraded throughout the evolution of the research program.

[3.b.11.1] H. Neilson et al, in Fusion Energy 2002 (Proc. 19<sup>th</sup> Conf., Lyon), paper IAEA-CN-94/IC-1. [http://www-pub.iaea.org/MTCD/publications/PDF/csp%5F019c/pdf/ic\\_1.pdf](http://www-pub.iaea.org/MTCD/publications/PDF/csp%5F019c/pdf/ic_1.pdf)

[3.b.11.2] [http://aries.ucsd.edu/raffray/FST\\_ARIES\\_CS/Aries\\_CS\\_FST\\_issue.shtml](http://aries.ucsd.edu/raffray/FST_ARIES_CS/Aries_CS_FST_issue.shtml)

[3.b.11.3] D.M. Mikkelsen et al, Fusion Sci. & Technology **51**, 166 (2007)

[3.b.11.4] H.E. Mynick and A.H. Boozer, Phys. Plasmas **14**, 072507 (2007).

[3.b.11.5] G.-Y. Fu et al, Fusion Sci. & Technology **51**, 218 (2007)

[3.b.11.6] G. Rewoldt, L.-P. Ku, and W.M. Tang, Phys. Plasmas **12**, 102512 (2005)

[3.b.11.7] A. Reiman et al, Fusion Sci. & Technology **51**, 145 (2007)

[3.b.11.8] P. Mioduszewski et al. Fusion Sci. & Technology **51**, 238 (2007)

[3.b.11.9] E. Lazarus et al, Fusion Sci. & Technology **46**, 209 (2004)

[3.b.11.10] E. Fredrickson et al, Fusion Sci. & Technology **51**, 232 (2007).

[3.b.11.11] N. Pomphrey et al, Fusion Sci. & Technology **51**, 181 (2007)

[3.b.11.12] H. Kugel et al, Fusion Sci. & Technology **51**, 203 (2007).

### 3.b.12. RFPs

The Reversed Field Pinch (RFP) configuration explores toroidal magnetic confinement with small external magnetization. In particular the applied toroidal magnetic field is nearly absent, typically ten times smaller than the poloidal magnetic field. The main fusion development challenges for the RFP are (1) to maximize improved confinement, (2) to demonstrate stabilization of multiple, simultaneously occurring resistive wall modes, (3) to develop current sustainment consistent with good confinement in steady-state or for an attractive pulsed scenario, and (4) to develop plasma-boundary control that would permit realizing a compact, high power-density fusion system. High beta values required for a compact fusion power core have been demonstrated experimentally, but the limits to beta have not been identified.

The understanding and physics performance of the RFP is much improved from that of five to ten years ago. Inductive current profile control is used to reduce tearing instability, thereby increasing confinement to a level comparable to a same-size, same-current tokamak. New RF current drive tools are under development to maximize and to sustain current profile control. This research will provide new information on RF physics relevant to stability and confinement in toroidal systems generally.

Mitigation of resistive wall modes is generically one of the most important fusion challenges in high beta toroidal confinement. Active control of many resistive wall modes has been demonstrated robustly in RFP plasmas with low rotation, an important result for toroidal confinement. Continued optimization of the control algorithms and tools is a major thrust in RFP research.

The capabilities and fusion science program emphases for the main RFP experiments are summarized below: the MST facility at the University of Wisconsin-Madison, the RFX facility in Padua, Italy, and the Extrap-T2R facility at the Royal Institute of Technology (KTH) in Stockholm, Sweden. There are in addition several smaller RFP devices operating at Japanese universities. RFP science also has strong connections to astrophysics, not described here.

#### **The MST facility (UW-Madison)**

The MST program is the centerpiece of the US proof-of-principle RFP program. It is focused primarily on improving RFP confinement through current profile control, and on identifying limits to beta. A novel steady-state inductive current drive scenario (AC helicity injection) is also being tested. Inductive current profile control has demonstrated a (transient) ten-fold confinement improvement by greatly reducing tearing instability. Further optimization of the inductive loop voltage programming remains high priority. In



*The MST Reversed Field Pinch*

## Draft FESAC sub-panel report – Do not circulate

addition, two RF current drive techniques are in development to facilitate more precise radial positioning of the auxiliary current drive and for longer duration, based on the lower-hybrid and electron Bernstein waves. These systems will also add significant non-Ohmic heating power, capability only recently appearing in RFP research. A 1 MW neutral beam is also planned, to assist assessing beta limit physics and to investigate energetic ion confinement. The MST device contains a thick conducting shell, so resistive wall modes are not easily accessible.

The MST lower hybrid experiment is one of two in the US, the other on Alcator C-Mod (MIT). The principal aim is current drive targeted to the outer region of plasma for profile control (tearing stability). Wave accessibility in the high beta RFP necessitates high parallel index of refraction for the launched wave. Strong, single-pass absorption is expected. A 200 kW, 800 MHz system is operating, and investigations of the wave propagation and absorption have begun. The current drive impact on MHD stability will be relevant to conventional and neo-classical tearing mode stabilization. A multi-antenna, 1-2 MW system will likely be required in the future. The electron Bernstein wave is being studied in addition to lower-hybrid (LH) to assess the trade-offs of wave-launching and absorption. The EBW is of interest to any high beta configuration where accessibility of cyclotron waves is cutoff. The antenna for EBW is more straightforward than for LH, but the coupling physics is not well established. This is a high interest research area worldwide, with collectively modest current drive and heating results to date. A 4-wave-guide system operating at 200 kW is presently in development.

The MST program also emphasizes novel diagnostic development. Some highlights are magnetic field measurements by Faraday rotation and the motional Stark effect (utilizing the full Stark manifold), high frequency capable Thomson scattering based on novel high rep-rate lasers, novel techniques and spectroscopic analysis for charge exchange recombination (CHERS) impurity ion temperature and flow, and Rutherford scattering measurements of the majority ion temperature and flow (plasma momentum). Both equilibrium and fluctuation measurement capability are emphasized. Several of these developments are impacting the direction of diagnostic implementation on ITER.

MST features: major radius,  $R=1.5$  m; minor radius,  $a=0.5$  m, plasma current,  $I_p=0.6$  MA; pulse length, 0.1 s, thick metal shell, lower hybrid and electron Bernstein RF systems in development (each 0.2 MW at present), 1 MW neutral beam injection planned, programmable control of the poloidal loop voltage under construction.

### **The RFX facility (Italy)**

The world's highest power RFP facility is RFX-Mod, with a designed plasma current capability of 2 MA. The plasma is surrounded by a metal shell with a vertical field penetration time of 50 ms. The centerpiece of a recent facility upgrade is a 192 coil system which fully covers the 2D toroidal surface for active and broadband MHD control. Each of these coils is independently driven. The feedback control system has demonstrated simultaneous control of more than 10 resistive wall modes, an important achievement with broad implications for high beta toroidal confinement. Control is achieved with little or no plasma rotation, so direct feedback of the modes is clearly

## Draft FESAC sub-panel report – Do not circulate

demonstrated. The program is rapidly progressing in studies of optimized feedback scenarios, for example projecting radially inward the control surface for the normal component of magnetic field to minimize plasma-surface interaction, and understanding side-band interactions that result in any control system with finite number coils. Employing robust control will be an important element in attaining high current in RFX, to control severe plasma-wall interaction consequent from unmitigated resistive wall modes.

A new paradigm for an RFP in a relaxed state having a single helical mode and no magnetic stochasticity has been discovered in MHD computation, providing another path for improved confinement (alternate to current profile control). The flexible active control system on RFX can isolate the control of a single Fourier mode to hopefully stimulate the production of a single-helicity state. This state has helical symmetry, resembling a stellarator in some respects. Observations of quasi-single-helicity conditions in all RFP plasmas, where one mode becomes much larger to create a helical island structure with hotter plasma inside, bolsters this path.

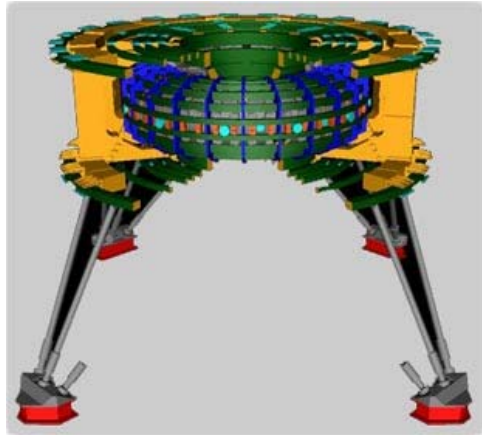

*The RFX Reversed Field Pinch*

The RFX facility also employs flexible inductive programming for both the toroidal and poloidal loop voltages. The sustainment of RFP plasmas is a relatively difficult challenge, given that pressure-driven currents are small. Optimization of inductive current drive, for either steady-state or attractive pulsed scenarios requires such flexible power control. Building on this power engineering expertise, the RFX program will host the test facility for ITER's negative-ion-based neutral beam sources.

RFX features: major radius,  $R=2.0$  m; minor radius,  $a=0.46$  m, plasma current,  $I_p=1.2$  MA (2 MA designed capability), pulse length, 0.4 s, resistive shell wall time, 0.05 s, 192 saddle-coil active control system, programmable control of both the poloidal and toroidal loop voltages, 1 MW neutral beam heating planned.

### **The Extrap-T2R facility (Sweden)**

The RFP community enjoys two complementary facilities with research emphasis on active MHD control. The Extrap-T2R is smaller than RFX, but it similarly employs a full coverage active feedback coil system totaling 128 coils and independent power supplies. The vertical field penetration time of the resistive shell surrounding the plasma is 6.3 ms. Active control of all resistive wall modes has been demonstrated for pulse lengths up to 0.1 s, limited by the loop voltage power supplies, not by consequences from the residual resistive wall mode spectrum. This corresponds to active control up to 15 wall-times, with no indication of long-pulse control issues.



## Draft FESAC sub-panel report – Do not circulate

Most high beta magnetic configurations exhibit a variety of MHD behavior, and coupling between types of instabilities could be a danger. The Extrap-T2R active control program aims to elucidate the linear and nonlinear physics associated with mode-sideband coupling in the control system. One practical goal is to understand what determines the minimum required number of control coils. A large part of this study is optimizing the magnetic sensors, e.g., comparing field components or combinations of components. Sensitivity to and mitigation of non-ideal effects in the signal processing will also be investigated, e.g., signal noise and coil misalignment.

Wall locking of the usually rotating resonant tearing modes is an important issue that remains not completely understood. The versatile capability of the active control system permits pre-programmed action on a single mode, thereby adjusting the drag force created by the mode. Understanding the physics that determines the locking threshold and its parameter dependence will be a primary goal.

The internal surfaces in contact with the plasma are all-metal in Extrap-T2R, primarily molybdenum limiters. The heat loads on these limiters is fairly large, typically about  $2 \text{ MW/m}^2$ . Spatially resolved spectroscopic measurement will be used to investigate the influx and accumulation of metal impurities, and surface collector probes will be used to investigate impurity accumulation. The data will be compared with models for a heat pulse on the limiter surface.

Extrap-T2R features: major radius,  $R=1.24 \text{ m}$ ; minor radius,  $a=0.18 \text{ m}$ , plasma current,  $I_p=0.3 \text{ MA}$ , pulse length,  $0.1 \text{ s}$ , resistive shell wall time,  $0.0063 \text{ s}$ , 128 saddle-coil active control system, all-metal plasma facing surfaces.

### 3.b.13. Spherical Tokamaks

World research on the Spherical Torus (ST) is dominated by the two mega-ampere class devices currently in operation, 1) the National Spherical Torus Experiment (NSTX) at PPPL in the United States and 2) the Mega-Ampere Spherical Tokamak (MAST) at Culham Science Centre in the United Kingdom. These devices are focused on developing the ST as a potential component test facility and fusion reactor. In addition, these devices contribute to the knowledge base of toroidal confinement physics by expanding the range of parameters in the international databases.

#### US STs

**NSTX** - The most powerful ST facility in the world with state-of-the-art diagnostic systems, addressing the full range of scientific topics, including ST-specific integration issues.

**Mission** - To provide the physics basis for future ST based devices, such as a high heat flux first wall material testing device, ST-CTF and ST-Demo, to broaden the physics basis for ITER while actively participating in ITPA and US BPO, and to advance the understanding of toroidal magnetic confinement.

## Draft FESAC sub-panel report – Do not circulate

Integrated steady state operation – NSTX has already achieved very long pulse ( $\tau_{\text{pulse}} \gg$  current redistribution time) at  $\beta_N \sim \beta_{N\text{with\_wall}}$ . For future scenario development, the primary target scenario for NSTX is based on the requirements for proposed future steady-state low aspect ratio devices such as NHTX and the ST-CTF. In particular, to demonstrate steady state operation at normalized plasma pressures at or above the requirements for these devices. In particular upgraded NBI injection capability will enable the study of off-axis NBI current drive as a tool for maintaining 100% non-inductive sustained operation. In addition, non-resonant magnetic braking in concert with the strong unidirectional momentum injection from NBI will be used to control the rotation profile. Investigation into the effectiveness of EBW as a heating and current drive tool is beginning and will determine whether this tool will be viable for current profile control on future devices. Extended TF pulse length will enable the study of low-collisionality plasmas with good NBI confinement. Plasma control development, done in collaboration with DIII-D is a major focus of the integration group. Plasma control developments will include the incorporation of the neutral beam injection into the control system. Additional diagnostic measurements will also be obtained in realtime including: motional Stark-effect polarimetry for current profile control, charge exchange recombination spectroscopy for rotation profile control, and Thomson scattering for equilibrium reconstruction constraint. A liquid lithium divertor plate will be investigated as a means for heat and particle flux control. NSTX is capable of operating at very peak high heat flux, similar to ITER.

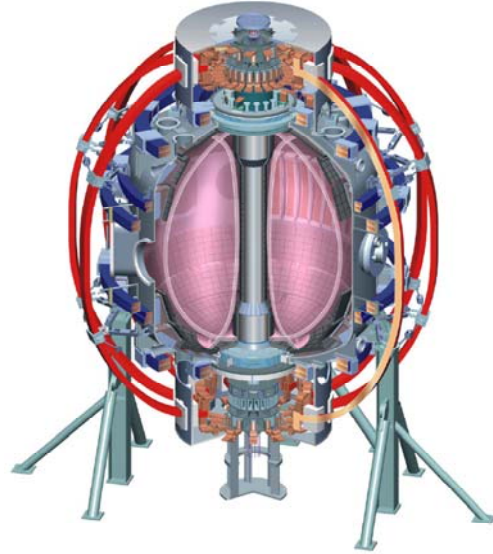

*Cross-section of the NSTX device showing major device components.*

ITER support – NSTX is leveraging its large accessible operating space to elucidate a number of physics issues that are crucial to ITER success. In particular, NSTX can achieve and exceed the ratio of fast particle pressure to total pressure that ITER will have while simultaneously matching or exceeding the ratio of  $v_{\text{fast}}/v_{\text{Alfvén}}$  for ITER while measuring the current profile and the fast particle density profile and edge losses. This enables the study of overlapping fast particle modes, the so-called “sea of Alfvén waves”, which is anticipated to be present on ITER. In addition, NSTX can achieve peak heat fluxes that match that expected for ITER. ELM studies, undertaken under the auspices of ITPA joint experiments with DIII-D and C-Mod, have elucidated the issues for access to small ELM regimes, which may be crucial to ITER success. NSTX is also investigating the effect of RMPs on ELM stability, helping to elucidate the physics behind this important control tool. The physics of surface waves, which were found to be important when coupling HHFW to NSTX plasmas, is an important area where NSTX can help ITER.

## Draft FESAC sub-panel report – Do not circulate

Toroidal confinement physics – Because NSTX operates in a unique regime, it is able to access important plasma physics that has traditionally been difficult to access in conventional aspect ratio experiments. As an example, a high-k scattering system which was recently commissioned on NSTX, is illuminating and quantifying the fluctuation spectrum that is believed to be responsible for anomalous electron transport in tokamaks. NSTX operates with a large normalized electron gyro-radius, enabling this measurement. NSTX is investigating the physics of non-axisymmetric control including such varied topics as RWM feedback, error field control, non-resonant rotation damping, resonant field amplification, tearing mode locking to error fields, and ELM suppression. By doing these experiments in a complementary parameter space (high- $\beta$ , low-A) NSTX can provide critical insight into the physics of non-axisymmetric effects.

Facility Development Plan -The table below illustrates the planned facility upgrades that will support the broad scientific goals for NSTX. Major improvements include an additional 7MW NBI, 1MW of EBW/ECH, liquid lithium divertor, TF sub-cooling to increase the pulse length, and upgraded non-axisymmetric coil capability.

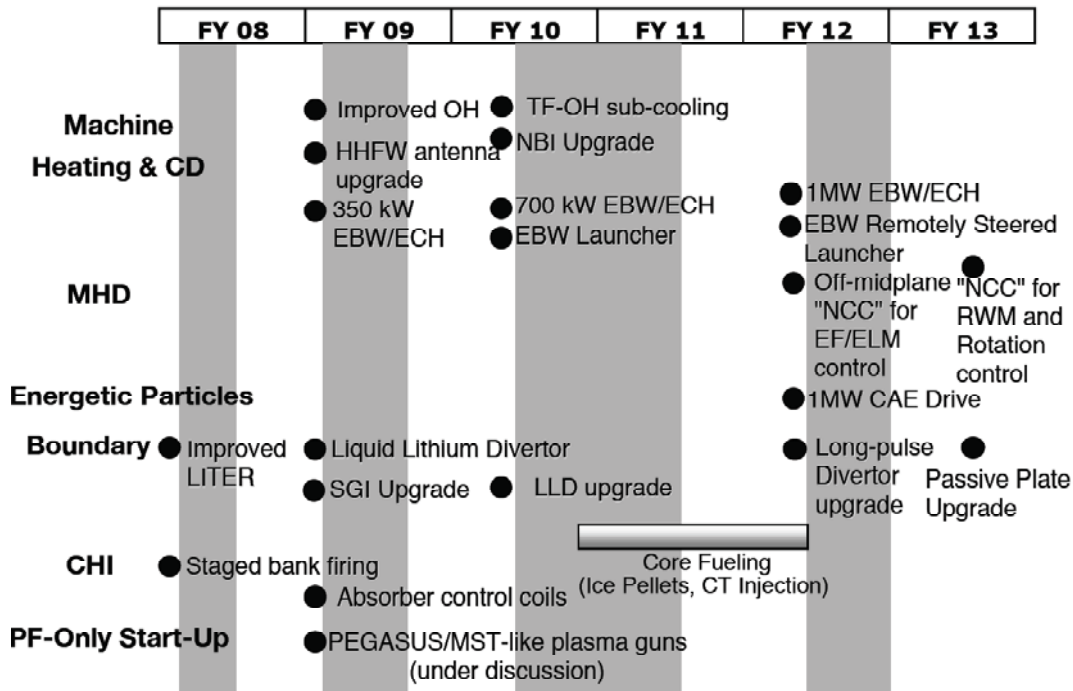

Table showing the NSTX facility upgrade plan (from "NSTX 5 year plan")

**HIT-II** - Developed CHI to start the plasma non-inductively; Applied on NSTX.

**PEGASUS** - the lowest aspect ratio device ( $R/a \sim 1.1$ ) to explore the benefit of this regime including very high beta operations. Also investigating an innovative start-up technique based on plasma guns which can be also applied to NSTX.

## Draft FESAC sub-panel report – Do not circulate

**LTX (CDX-U)** - the lowest particle recycling (~30%), and improved confinement with liquid lithium based approach. To be applied on NSTX.

### International STs

**MAST**, Culham, UK - A mega-ampere class ST with many complementary features to NSTX. MAST has a large vacuum vessel but no stabilizing plates, excellent set of profile and boundary diagnostics. MAST has 5MW NBI and EBW heating. Confinement, H-mode, and boundary physics. MAST uses as innovative start-up technique utilizing internal poloidal field coils called induction-merging startup. MAST has as a major mission element the support of ITER by studying ELM physics and divertor physics.

**GLOBUS-M**, Ioffe Physico, RF - Medium size ST with  $R/a = 1.5$ ,  $I_p \sim 300$  kA. Uses ICRF and NBI for heating, plasma jet for fueling studies.

**TST-2**, Tokyo University, Japan - Small size ST with  $I_p \sim 140$  kA . HHFW and EBW physics.

**TS3 and 4**, Tokyo University, Japan - Small size STs. Spheromak merging to obtain high beta STs with internal coils. Short pulse with  $I_p < 300$  kA.

International STs currently under construction

**QUEST**, Kyushu University, Japan - Follow-on device of TRIAM. QUEST will be a medium size, long-pulse, focused on non-inductive operations. First stage to start in ~ 2008 with  $I_p < 100$  kA.

**UTST**, Tokyo University, Japan - Follow-on device to TS3/4 and TST-2. Double null formation with more reactor relevant external PF coils. UTST aims to achieve very high beta with plasma merging. First plasma in 2007.

### 3.b.14. SST-1

#### Mission/Program

SST-1 is a new long pulse, superconducting tokamak being commissioned at the Institute for Plasma Research, Gandhinagar, India. It will produce elongated, double-null divertor hydrogen plasmas. Both the toroidal and poloidal field magnets are superconducting, while the Ohmic transformer is normal conducting.

Key physics issues to be addressed in SST-1 are energy, impurity, and particle confinement in long pulses up to 1000 s, particle and heat removal up to  $1 \text{ MW/m}^2$  during these long pulses, and long term stability of shaped plasmas in high beta advanced tokamak regimes, including resistive wall mode control.

The facility includes a variety of auxiliary heating and current drive systems, including ICRH, ECRH, NBI and lower hybrid current drive. Although these represent a total heating and current drive power of 4 MW, a maximum 1 MW total steady-state (long pulse) input power is accommodated by the plasma facing component heat removal system. The combination of LHCD and bootstrap current are anticipated to provide at least 0.1 MA in long pulse.

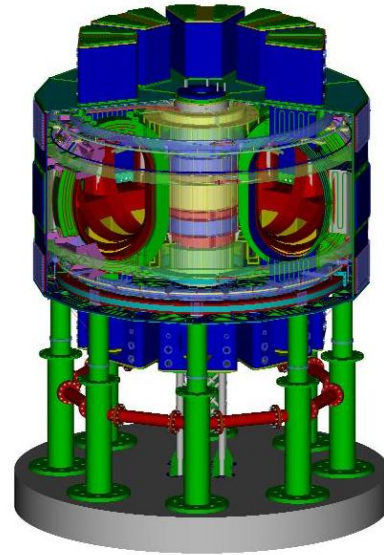

*The SST-1 Tokamak*

### **SST-1 Parameters & Capabilities**

$B = 3.0 \text{ T}$

$I_p = 0.22 \text{ MA}$

$R = 1.1 \text{ m}$

$a = 0.2 \text{ m}$

$\kappa = 1.7\text{-}1.9$

$\delta = 0.4\text{-}0.7$

$P_{\text{ICRH}} 1 \text{ MW @ } 22\text{-}91 \text{ MHz}$

$P_{\text{LHCD}} 1 \text{ MW @ } 3.7 \text{ GHz}$

$P_{\text{ECRH}} 0.2 \text{ MW @ } 84 \text{ GHz}$

$P_{\text{NBI}} 0.8 \text{ MW @ } 10\text{-}80 \text{ keV}$

Pulse duration 1000 s

### **Schedule/Plans**

The fabrication of SST-1 has been completed and commissioning is underway. A first phase operation is planned that begins with circular plasmas and evolves to full power operation in diverted configurations. Later in the first phase, circular plasmas with LHCD assist and elongated plasmas with LHCD only will be investigated. A second phase is planned to explore advanced tokamak configurations.

### **References**

[3.b.14.1] Y.C. Saxena et al, FT/2-1, 21<sup>st</sup> IAEA Fusion Energy Conference, Chengdu, China, 2006.

### 3.b.15. TEXTOR

#### Mission/Program

TEXTOR, located at the Institut Für Energieforschung (IEF) in Julich, Germany, is a mid-sized limiter tokamak with a circular cross-section. Its research program is oriented toward the issues of plasma wall interactions and plasma facing components (PFC) in support of ITER and W7X. This includes the study of particle and energy exchange between the plasma and first wall and vacuum vessel as well as active measures to control the edge plasma and to reduce heat loads, particle release and impurity influx to tolerable levels. TEXTOR is designed with good access for edge diagnostics, facilities to heat the vacuum vessel and liner and provisions to replace the liner as necessary. A series of upgrades added a number of auxiliary heating systems, a toroidal pumped limiter and most recently a coils to produce a dynamically controllable ergodic divertor. Other aspects of the facility are also optimized for study of plasma wall interactions. An air-lock system allows for the fast exchange of sample PFCs. The ability to heat the limiter and first wall to 1600 C allows investigations into the temperature dependence of plasma interactions. The machine has an extensive diagnostic set for studying the edge plasma and wall.



*Interior of the TEXTOR Tokamak*

A major element of the program is the development and validation of numerical models for the plasma edge and plasma wall interactions. Important questions addressed include the identification and characterization of erosion and redeposition mechanisms in fusion-relevant first wall materials (C, Be, W); investigation of tritium retention; and prediction of PFC lifetimes for ITER under normal and off-normal conditions. Considerable attention has been paid to impurity dynamics and transport, including sources generated by plasma wall interactions. Using impurity injection techniques and a spectroscopic diagnostics, impurity diffusion and convection has been extensively studied. Improved modeling techniques and atomic data have been used for the analysis of spectra.

The most recent initiative on TEXTOR is the dynamic ergodic divertor (DED). The DED is created by a set of non-axisymmetric coils which can create perturbations with a variety of poloidal and toroidal mode numbers. The aim is to control heat and particle exhaust by distributing the load over large areas, which can be moved dynamically. A second goal is to modify plasma transport, particularly for impurities, via ergodization of the edge magnetic field with the objective of increasing impurity screening and enhanced radiative cooling. The coil set can also be used in experiments to induce rotational shear and to explore the application of external rotating magnetic fields to suppression of MHD instabilities. Fundamental study of transport and stability in these three-dimensional fields could be useful in understanding the role of such coils for ELM suppression and RWM control.

### TEXTOR Parameters & Capabilities

R = 1.75 m  
a = 0.47 m  
Plasma Cross Section circular  
BT = 3.0 T  
IP = 0.8 MA  
Pulse Duration 10 s  
Installed Heating Power = 9 MW  
Heating Methods: NBI, ICRH, ECRH

### Schedule/Plans

Short term plans include development of techniques for removal of deposited carbon layers; modeling of tritium retention in ITER; investigation of high-Z PFCs and mixed materials at high heat loads; continued exploitation of the DED coils set for studies of plasma rotation and stability; and studies of tearing mode feedback stabilization via ECH and ECCD. Long term prospects for TEXTOR operation are not clear at this time. Decisions are pending on an EU facility review and the next (2009-2013) German five year plan.

### 3.b.16. Tore-Supra

Tore Supra [3.b.16.1] is a large (R = 2.25 m, a = 0.7 m, B = 4.5 T) circular cross-section tokamak device with superconducting toroidal field coils that began operating in 1988 at the Centre d'Etudes de Cadarache, France. Tore Supra is the first tokamak constructed specifically to explore the possibilities of steady state operation. Its power and plasma heating supplies and in-vessel components—RF antennas, lower hybrid launchers, limiters, and wall components—are all actively cooled, and the heat handling capacity of the

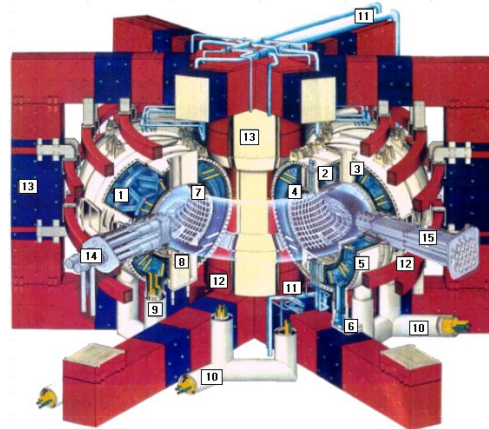

*Cutaway drawing of the Tore Supra device.*

## Draft FESAC sub-panel report – Do not circulate

torus is 15 MW for 1000 s. This performance is representative of ITER operation in terms of average power density and heat exhaust capability. Plasma heating is accomplished using long pulse ICRF (10 MW) and lower hybrid (6 MW) heating systems.

Key results of Tore Supra experiments so far are: [3.b.16.2-4]

- Stable, steady-state discharges using lower hybrid current drive (power  $\leq 3$  MW, central density  $< 3 \times 10^{19} \text{ m}^{-3}$ , plasma current  $< 0.6$  MA) and lasting more than 6 min with a total injected energy of 1 GJ have been obtained.
- High-power, high density discharges with central density  $5 \times 10^{19} \text{ m}^{-3}$ , plasma current 0.9 MA, and  $B = 3.8$  T have been sustained in stationary conditions for periods of 15 seconds using 1.4 MW of lower hybrid current drive and 8.4 MW of ICRF power (H minority fraction  $\sim 12\%$ ). These discharges operated at 80% of the Greenwald density and  $\beta_p \approx 1$ , with  $T_{i0} \approx T_{e0} \approx 4\text{-}5$  keV. The normalized density and  $T_i/T_e$  ratio are similar to those envisaged for ITER steady-state operation, and the thermal stored energy exceeds that predicted by ITER L-mode scaling.
- Real-time feedback control of the current profile in lower hybrid current driven discharges with additional ICRF heating (total LH + ICRF injected power = 7 MW) has been used to maintain a moderate density ( $n_{e0} = 3 \times 10^{19} \text{ m}^{-3}$ ) plasma in an MHD stable configuration in stationary conditions for periods of 60 s.
- Achievement of this long pulse, high power performance has been critically dependent on the development of real-time monitoring, diagnostic physics studies, and modelling of the interactions of the edge plasma with actively cooled high power lower hybrid launchers, ICRF antennas, the large toroidal pumped limiter, and the vacuum chamber walls. This research includes ongoing investigations of the mechanisms of deuterium retention in PFC components.

Near term plans for Tore Supra focus on the extension of high total injected power ( $>15$  MW), to durations  $> 30$  s using improved klystron sources for lower hybrid power and advanced launchers and ICRF antennas which will test concepts being developed for ITER.

[3.b.16.1] J. Jacquinot, Nucl. Fusion **45**, S118 (2005).

[3.b.16.2] M. Chatelier, et al, Nucl. Fusion **47**, S579 (2007).

[3.b.16.3] M. Goniche, et al, Nuclear Fusion, **28**, 919 (1998).

[3.b.16.4] L. Colas, et al, Nucl. Fusion **46** S500 (2006)

### 3.b.17. Wendelstein-7X (W7X)

Located at the Max-Planck Institut für Plasmaphysik in Greifswald, Germany, W7X is a large ( $R = 5.5$  m,  $a = 0.53$  m,  $B = 3$  T) superconducting modular stellarator device that is scheduled to begin operating in 2014 [3.b.17.1-3]. Its magnetic

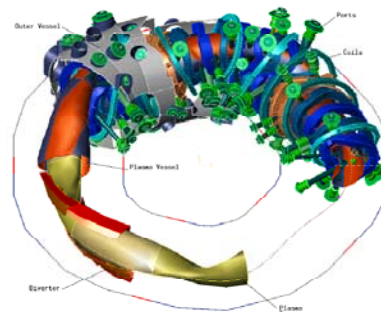

*Cutaway drawing of the W7X Stellarator.*



## Draft FESAC sub-panel report – Do not circulate

configuration is referred to as a helias, and is formed by a set of 50 non-circular, non-planar, “twisted” modular coils arranged in five periods around the torus. An additional set of 20 planar toroidal field coils allow the rotational transform ( $t = 1/q$ , where  $q$  is the safety factor) to be varied above and below its nominal value (near unity) for experimental flexibility. The helical fields also provide a helically twisting divertor configuration. The divertor and vacuum chamber are covered with graphite-composite tiles which are actively cooled to permit operation for periods  $\sim 30$  min (steady-state). Initial heating will be provided by 10 MW of ECRH from ten 140 GHz CW gyrotrons, 4 MW of ICRF (also cw) and 5 MW of 60 keV NBI (15 s every 3 min). Subsequent increases in power to 9 MW of ICRF and 20 MW of NBI are planned.

The helias configuration comprises fields of several different helicities, and was numerically optimized to have a number of special properties. The closed flux surface configuration is *isodynamic*, so that the toroidal Pfirsch-Schlüter currents are greatly reduced, so that the Shafranov shift essentially vanishes for volume-averaged  $\beta$  of up to more than 5%; the configuration is calculated to be stable to at least these values of  $\beta$ . The field structure is designed so that components of the bootstrap driven by the toroidal and helical field variations (which flow in opposite directions) cancel to a high degree. The field configuration is thus practically insensitive to variations in plasma parameters. It is also designed to have a low effective helical ripple  $\sim 1\%$ , and trapped particles are generally well confined, and confinement is further improved by the ambipolar radial electric field and the deepening of the diamagnetic well by finite- $\beta$  effects. The consequence of the W7-X design is that the plasma is expected to have low neo-classical fluxes, good high-energy particle confinement, passively maintain its optimization at high  $\beta$  with grossly stable operational and to allow steady-state operation without external current drive.

The mission of W7-X is to demonstrate the basic reactor suitability of this concept. Some of the properties have already been tested by W7-AS, the predecessor of W7-X. W7-AS was partially optimised in its magnetic field characteristics, showed the feasibility of modular coils, demonstrated access to H-mode confinement regime, and sustained  $\beta = 3.2\%$  for more than 100 energy confinement times without any disruptions. W7-X will study confinement and stability of high  $b$  plasmas, and demonstrate they can be sustained in steady state. The application of the W7-X design principles to reactors has been studied in the HELIAS reactor design, incorporating the results from W7-AS. W7-X will test whether these characteristics can be obtained. In addition, W7-X will contribute to the development of steady-state technologies and operation, including power handling, RF launcher systems, and experience operating 3D superconducting coils.

[3.b.17.1] M Wanner and the W7-X Team, Plasma Phys. Control. Fusion **42** 1179 (2000).

[3.b.17.2] F. Wagner et al, Physics, Technologies and Status of the Wendelstein 7-X device Proc. of the IAEA Fusion Energy Conference in Villamoura, paper FT/3-5 (2004).

[3.b.17.3] F. Schauer and W7X Team, 24th Symposium on Fusion Technology (SOFT24), Warsaw, (2006).

### 3.c. Large Scale Modeling Projects

#### 3.c.1 FSP

The fusion simulation project is an initiative in the US with the intended goal of creating a comprehensive suite of integrated modeling codes. There are four drivers for the program 1) the need to support ITER and extend plasma simulation capabilities into a broader multi-physics, multi-scale domain 2) recent progress in plasma theory and computation and improvements in algorithms, numerics and applied math 3) the need to integrate physics understanding obtained from research across the entire program and 4) the availability of increasingly powerful computers. Currently, only pilot projects are funded but the aim is to launch a large program that would cost on the order \$20M per year.

With respect to ITER, the highest level goal of the FSP is to contribute to making ITER a successful project. Simulation must support both operational and scientific requirements in order to most fully exploit what will be the largest, most expensive scientific instrument ever built for fusion plasma research. These requirements are not thought to be divergent, since the operational needs can only be answered through improved scientific understanding. Specifically, simulations would:

1. Help carry out the experimental program more efficiently – that is, to make the best use of the finite number of ITER pulses.
2. Enable new modes of operation, with possible extensions of performance.
3. Increase the scientific return on the government's investment in the project through improvements in data analysis and interpretation.
4. Provide an embodiment for the scientific knowledge collected on ITER.

There are further goals for the FSP which align with the OFES mission to "advance the knowledge base needed for an economically and environmentally attractive fusion energy source". To this end, the FSP proposes to carry out cutting edge research across a broad range of topics in computational plasma physics. A project structure is envisioned where research components are developed, verified and validated, then migrate into the production suite. This migration may take place by creation and improvements of reduced models or by direct incorporation into the production codes.

If successful, the FSP would produce widely-used computational tools in support of a wide range of OFES programs. There would be a greater degree of emphasis on software engineering and user support which should allow the codes developed by the FSP to be broadly distributed and exploited. The impact could be felt across a large segment of the fusion energy program.

It is worth noting two related international projects, the European Integrated Tokamak Modeling (ITM) task force and the Japanese Burning Plasma Simulation Initiative which are described below.

### 3.c.2. Large scale European and Japanese plasma computation

#### EU – Integrated Tokamak Modeling Task Force (ITM-TF)

In Europe, an EFDA task force on Integrated Tokamak Modeling has been formed with the aim of providing a set of codes necessary for planning, operation and analysis for ITER. To achieve their goals, four topical research areas have been identified, which have formed the structure of the ITM-TF: Identification of Codes & Models, Interfacing Procedure and Numerical Support, Code Validation and Benchmarking, ITER Integrated Scenario Activity. Two projects in informatics are supporting the development of physics codes. These are a Data Coordination Project, which is responsible for providing standardized data models and data access software; and the Code Platform Project, which will enable cross-coupling between codes and common interfacing. A particular concern is standard access to experimental to facilitate code validation. Procedures for software quality assurance and version control are being implemented. Five major physics projects have also begun, covering: equilibrium and MHD (IMP#1), non linear MHD, sawtooth and ELMs (IMP#2), energy and particle transport (IMP#3), first principle transport and turbulence (IMP#4) and fast particles and heating (IMP#5). These groups will be responsible for benchmarking and validating physical and numerical models. More information is available at <http://www.efda-taskforce-itm.org>

#### Japan – Burning Plasma Simulation Initiative (BPSI)

In Japan, the Burning Plasma Simulation Initiative combines the efforts of universities with the National Institute for Fusion Sciences (NIFS) and the Japanese Atomic Energy Agency (JAEA). Its goal is to integrate physics models, including transport, turbulence and MHD with models for heating, current drive and plasma wall interactions across a wide range of spatial and temporal scales. In the longer term, plasma physics and engineering codes would interact to include models for shielding and breeding blankets, materials interactions and heat and mass flow providing an overall simulation for burning plasmas. The basic integration approach is via loosely coupled modules interacting via common data structures. Staged development of new models would allow additional physics to be added as it becomes available. The initiative would incorporate new models for network or grid computing, modern code frameworks and advanced visualization techniques. Additional information is available at:

<http://p-grp.nucleng.kyoto-u.ac.jp/bpsi/en/>

### 3.c.3. Large scale simulations in support of technology

#### 3.c.3.i Materials Research

Due to the complexities of the fusion energy environment (simultaneous intense neutron and gamma ray irradiation, high heat fluxes, and high mechanical stresses) and the lack of a suitable experimental fusion materials testing facility, the development of materials for fusion energy applications must necessarily rely heavily on multiscale simulations. Modeling currently comprises about 25% of the US fusion materials research portfolio, and heavily leverages connections within participating research institutions to the broader

computational materials science community. The focus of the current fusion materials modeling activities is to discover the controlling physical mechanisms that determine the microstructural evolution (and corresponding property changes) in materials due to irradiation, with particular emphasis on mechanical property degradation. The relevant length and time scales span ten and twenty orders of magnitude, respectively, making it impossible for a single model to accurately describe the full breadth of physical processes. As noted in section 2.b.13, current state of the art multiscale modeling in computational materials science involves passing information between a series of specialized codes operating at different length and time scales, ranging from atomistic first principles models to massively parallel finite element codes. These codes are run on a variety of DOE Office of Science computational platforms (BES, FES, ASCR) ranging from workstation clusters to leadership class supercomputers.

The major components of the existing multiscale materials modeling activities for fusion applications include ab initio atomistic models to develop realistic interatomic potentials for pure metals and compounds, molecular dynamics simulations to study defect migration mechanisms and activation energies and interactions between radiation defects and the existing microstructure (e.g., dislocations) as well as details of the initial damage state created in neutron displacement cascades (source term for all subsequent radiation damage processes), kinetic Monte Carlo simulations to investigate radiation defect interactions within individual grains of a material, phase field and chemical rate theory models to investigate homogeneous microstructural evolution as well as radiation induced segregation and radiation induced precipitation processes, three-dimensional dislocation dynamics models to evaluate dislocation loop clustering and network dislocation evolution under mechanical stress, finite element models to evaluate effects of localized stress on fracture mechanics and overall deformation behavior in unirradiated and irradiated materials, and a variety of specialized models to investigate effects of irradiation on important properties such as thermal conductivity, fracture mechanics, etc.

### **3.c.3.ii Plasma wall interactions and plasma facing components**

Plasma wall interaction laboratory experiments and data from fusion machines have been used to validate models of erosion mechanisms, transport of impurities in the plasma edge, and retention of hydrogen isotopes in both eroded and redeposited material and in the original plasma facing material. The simulations are typically accomplished through the use of suites of codes where each sub-code computes specific physics in the interacting region. Examples of such suites include: 1)UEDGE coupled to REDEP and WBC, 2) B2 coupled to EIRENE, 3)UEDGE coupled to DEGAS2, and 4) the HEIGHTS code package for analyzing disruption and large ELM effects on surfaces. In addition, specialized codes are used to simulate erosion (Fractal TRIM), tritium transport in materials (TMAP), and various Molecular Dynamics codes to study low energy reflection and trapping of plasma particles. Efforts are underway to develop kinetic codes to simulate situations where fluid codes like UEDGE and B2 are inappropriate. As these code suites are improved to include more detailed physical models, the need for increased computing power increases. The coupling of all the physics in the edge region of fusion devices cannot be accomplished simultaneously because of limitations in computing resources. The need to simulate plasma wall interactions in ITER to guide the design of

## Draft FESAC sub-panel report – Do not circulate

ITER components has spurred the development of better coupling between the various sub-models.

Simulation of neutron transport, thermal-hydraulics, thermal-stress, and electromagnetic effects during disruptions that are required for ITER design have been carried out using various commercially available codes. These codes are typically used during the design of other large engineering projects. Geometric modeling of components is done using Computer Aided Design packages. Recent releases of fluid dynamics, and electromagnetic codes that have simple easy to use interfaces with the CAD codes have reduced the cycle time for design iterations. However, the complexity that must be included in the component model that is needed for even conceptual design forces the analysis of relatively small sub-components of PFCs rather than the complete device. While there are engineering codes that run on very large massively parallel computers, those codes and/or computers are typically not available for fusion device design. Because of the long time between design activities for fusion devices, the cadre of trained engineers who understand the unique features of fusion devices have disappeared to other fields before the next fusion device needs their skills.

### **3.c.3.iii Safety**

The Fusion Safety program has developed several simulation codes to predict the response of fusion systems to accident scenarios, generation of activated material, the transport of activated materials, tritium transport in fusion components, and arcing of superconducting magnets during quench. These codes have been used to develop the safety basis for ITER and in the formation of the USDoE Fusion Safety Code. MELCOR, a fission safety code, has been modified to include fusion specific characteristics such as large vacuum spaces and unique materials, and used to simulate the response of fusion device components to loss of coolant or loss of flow accidents. The probability of component failure is based on large databases on reliability of various types of components gathered and maintained by the IAEA. Transport of radioactive material as aerosols is part of the simulation. The objective is to predict site boundary dose and worker dose in the plant. TMAP is used to model the transport of hydrogen isotopes in materials and vacuum spaces in a fusion plant. Neutron transport is analyzed using codes like MCNP (Monte Carlo method) or ATILLA (finite element). Several codes are used to calculate activation of fusion materials given the neutron flux and energy distribution. Fusion magnets are more likely to be superconducting as longer pulse lengths are required. MAGARK is used to model quenches in superconducting coils and predict the probability of an electrical arc occurring. Experience gained from ITER licensing and operation will increase the confidence in these codes.

### **3.c.3.iv Fusion Engineering Sciences**

Fusion engineering scientific issues are substantially different than other energy sources including fission. Examples of these unique attributes include a) a very high surface heat flux and potentially high peaking factors, b) a complex volumetric heating source involving both plasma products (neutrons, particle, and radiation) as well as nuclear reaction in the power extraction components, c) strong impact of electromagnetic field (both static and dynamic) on heat transfer and fluid dynamics, d) large temperature and

## Draft FESAC sub-panel report – Do not circulate

stress gradients which can derive a multitude of complex physical phenomena, e) compatibility with the fuel cycle (tritium production, transport, and extraction), f) complex geometry, and g) an evolving material properties (e.g., due to radiation effect).

Because of the availability of large-scale computing, there has been a substation shift in engineering research towards science-based simulation tools as opposed to the empirical approach of repeated testing in prototypical environments (which is typically costly and time-consuming). Utilizing science-based simulation capabilities is essential for developing fusion engineering sciences as the prototypical fusion environment for empirical testing does not exist. Some examples of predictive simulation capabilities are given below:

1) Developing predictive simulation capabilities for the thermo-fluid dynamics of plasma facing components: “Traditional” approaches to high-heat flux components are not applicable to fusion because of potentially high peaking factors, large particle fluxes, electromagnetic loads, evolving material properties (due to both neutrons and particles fluxes), and geometrical constraints. Proposed solutions involve modifying coolant flow profiles (turbulent or transition to turbulent flows, impinging jets, etc.) which requires developing new understanding of heat transfer and fluid dynamics in regimes that have not been explored thoroughly before -- mainly through. Small bench-top experiments in relevant dimensionless parameters can be used to develop and bench mark computational fluid dynamics codes for this application.

2) Developing predictive capability for the thermo-fluid dynamics in the blanket: Utilizing lithium-bearing, liquid metal alloys as the coolant have significant advantages. The thermo-fluid behavior is strongly affected by the electromagnetic field confining the plasmas or generated by the plasma itself. The flowing liquid metal will experience  $\mathbf{v} \times \mathbf{B}$  forces (magnetohydrodynamic effects) that are many times larger than viscous and inertial forces. These forces have a large impact on flow profiles and heat transfer conditions. For fusion application, the science of liquid-metal MHD thermo-fluid dynamics should be extended to regimes with large variations in and gradients of the  $\mathbf{v} \times \mathbf{B}$  forces, time-dependent EM fields generated by the plasma operation, and intense nuclear heating. Three-dimensional simulation tools are necessary to understand and optimize the thermo-fluid dynamics in the blanket. Small bench-top experiments in relevant dimensionless parameters can be used to bench mark computational fluid dynamics MHD codes.

3) Developing predictive simulation capabilities of volumetric nuclear heating, tritium production, and changes induced in material constituents due to neutron-induced transmutation: The mean free-path for a 14-MeV neutron in material is typically 1-2 cm which can be comparable to many of the features (e.g., geometry, material composition) of the components surrounding a fusion plasma. It involves development of tools to accurately model the components surrounding the plasma (for example from CAD drawings) for analysis by the Monte-Carlo codes for neutron and radiation transport. Such a predictive capability can be benchmarked by

measurements (e.g., neutron flux) in present high-power plasma experiments as well as ITER.

### 3.d. Technology facilities including IFMIF

The world-wide fusion community has developed over the last fifty years a large set of dedicated facilities for developing and validating the technologies needed for fusion research. For some applications the fusion technology development program was able to utilize testing facilities produced for non-fusion research (some with defense oriented objectives), which matched the needs of the fusion program, and provided an economical path to validate technological issues. Since Demo will have new or increased demands on technology as the era of high neutron fluence commences, Testing Facilities world-wide will need to be enlisted or developed to meet the program objectives. Facilities that appear to be of interest during the period between ITER and Demo can be grouped into the following eight categories; PFC/Divertor Validation, Heating & Current Drive Technology, Fueling and Exhaust, Magnet Technology, Tritium Breeding and Extraction, Remote Handling, Power Supplies and Structural Materials. Generally existing facilities developed for ITER and other fusion programs should be sufficient, but in other cases, such as 14 MeV high neutron fluence sources, completely new facilities will have to be developed and commissioned. An overview of existing or planned facilities in each of the eight areas follows.

#### 3.d.1 PFC/Divertor Validation

Historically, new materials and PFC fabrication techniques have been studied and improved through the use of dedicated test facilities located in many countries involved in fusion research. Understanding of the capabilities of proposed designs for PFCs and the failure mechanisms most likely to occur during expected operating scenarios including transient events were determined as a result of careful experiments on such facilities. Several new materials have been confirmed for use in fusion devices through the research conducted in such dedicated test facilities. Examples include carbon-carbon fiber composites, mechanical attachment schemes for short pulse devices and actively cooled PFCs for Tore Supra in the late 1980's. Experiments on concepts for the ITER divertor were conducted all through the Engineering Design Activity (EDA, a total of 7 years duration). The capability of PFCs to remove steady state heat flux increased from about 1 MW/m<sup>2</sup> to above 10 MW/m<sup>2</sup> during this activity. Comparative studies were carried out on several heat sink designs to assure reliability of the heat sink and the heat flux limits. These studies enabled the choice of designs that were optimized for use on ITER. Moving from ITER to Demo will require understanding of Helium cooled heat sinks since water is too reactive with high temperature PFCs to be acceptable for Demo. Helium coolant loops for PFCs are being added to existing test facilities but further upgrades (higher mass flow, higher operating temperature) are needed to meet the needs of Demo. Refractory metals needed for Demo further emphasize the need for alternative coolants. Much higher neutron radiation damage must also be withstood by the components. Some new test facilities have been created and existing facilities upgraded to support the ITER mission or fusion devices under construction. Only one facility has the capability of testing irradiated components similar to what might be found on a Demo.

## Draft FESAC sub-panel report – Do not circulate

At least two additional irradiated material test facilities able to handle components up to 0.5 m<sup>2</sup> (> 600 kW heating capability) are needed for Demo preparation. The following table summarizes the existing and planned facilities capable of PFC testing and development.

*Table 3.d.1  
High Heat-Flux Test Stand Facilities*

Facility	Capability
China	
CEBTF (China Electron Beam Test Facility) SWIP	30 kW (80X80 mm <sup>2</sup> ); water coolant; Optical pyrometer; IR camera; Operation started June 2007
HTHEL (High Temperature Helium Loop) SWIP	500-700 C; 8-10 MPa; flow rate unknown; proposed for construction
European Union	
Thermal Fatigue Test Facility (NRI, Czech. Rep.)	IR heaters (carbon), Water coolant (~3 MPa); RT-150C; 0.8 MW/m <sup>2</sup> ; Steady state; ITER testing; Be capable; operational January 2008
JUDITH I and JUDITH II (FZJ, Juelich)	Electron beam; 60 and 200 kW; Water coolant; up to 0.5 m <sup>2</sup> ; <b>only hot cell facility</b> ; Be capable; ~1 ms to steady state
FE200 (CEA/AREVA)	Electron beam; 200 kW; <10 MW/m <sup>2</sup> (large area) to <10 GW/m <sup>2</sup> (small area, short pulse); No Be
GLADIS (IPP Garching)	Neutral Beam; two sources; <2 MW total; 1-50 MW/m <sup>2</sup> ; <15 sec; water coolant
PSI-2 (Humbol Univ., Berlin)	Plasma Surface Interaction linear plasma device
MAGNUM PSI (FOM, Netherlands)	Plasma Surface Interaction linear plasma device
SATIR (CEA, Cadarache)	Hot and cold water component test facility
Japan	
DATS (JAEA, Naka)	Neutral Beam; 3-10 MW; water coolant RT-400C; 1-25 MPa; No Be
JEBIS (JAEA, Naka)	Electron Beam; 400 kW; water cooled; 4 MPa; No Be
Russia	



## Draft FESAC sub-panel report – Do not circulate

TSEFEY (Efremov)	Electron Beam; 60 kW (upgrade to 200 kW planned in 2008) ; water coolant; Be capable
QSPA and MK-200 (Tomsk)	ELM and Disruption simulation using plasma guns; 1-10 MJ/m <sup>2</sup> ; <0.5 ms; B ~ 2T
USA	
EB-60	Electron Beam; 60 kW; < 8 MW/m <sup>2</sup> ; 0.1 ms to steady state; water coolant RT-250C; < 5 MPa; He coolant loop (20 g/s, <300C, < 5 MPa; upgrade to 200 g/s and 700C under construction); IR pyrometers; IR cameras
EB-1200	Electron Beam: 1200 kW; <16 MW/m <sup>2</sup> ; maximum area ~ 0.32 m <sup>2</sup> ; Water and helium coolant same as for EB-60 above

### 3.d.2 Heating & Current Drive Technology

There are four main technologies that have been and will continue to be envisioned for heating or driving current in plasmas as fusion research progresses towards Demo. The four technologies are:

- Particle Injection, also known as Neutral Beam Injection, NBI. –is the process by which high velocity particles (normally isotopes of hydrogen) are injected into the core of the plasma, and through collisions transfer energy to the plasma.
- Electron Cyclotron Heating and Current Drive, ECH or ECCD –is the process by which high power microwaves interact with the plasma electrons, where the microwave frequency (100+ GHz) and the resonant plasma frequency match. At the resonant zone energy in the microwave beam is efficiently transferred to the electrons.
- Ion Cyclotron Heating and Current Drive, ICH or ICCD – Which covers two different processes, but uses the same technology of Radio Frequency Waves. In one process Radio Frequency, RF waves (30 – 120 MHz) interact with the ions, at the ion cyclotron frequency and transfers energy to the ions directly. The other process is where RF Waves are launched from a phased array antenna and the waves interact with the electrons. This process both heats the electrons and drives current where the coupling of the wave velocity and the electron velocity is maximum (normally in the core of the plasma).
- Lower Hybrid Current Drive, LHCD – is the process where RF waves at the Lower Hybrid frequencies (LHf = square root of the product of the ion cyclotron frequency and the electron cyclotron frequency) (3 – 8 GHz) are launched into the

## Draft FESAC sub-panel report – Do not circulate

plasma with its electric field parallel to the magnetic field, so it can easily accelerate electrons along the field lines.

### 3.d.2.1 Neutral Beam Injection Test Facilities

As the plasma densities of fusion experiments have increased over the last few decades and into the future, looking towards Demo, the energy needed from the neutral beam systems has risen from 100 keV to 1 MeV and higher. The technological challenges for MeV grade NBI systems are the development of high power, high reliability, DC power supplies, MeV feedthroughs, negative-ion ion sources, and accelerating grid assemblies. Generally dedicated test stands are assembled to test specific sub components, sometimes at reduced size (e.g. an ion source test stand that tests a smaller size unit to validate current density extraction validation). Eventually an integrated test stand is assembled to test a full system.

The highest performance neutral beam test stand is the 1 MV 40 A system being proposed to be constructed at the RFX facility in Padua, Italy. This will be able to test a full sized ITER negative ion based source and accelerator at full parameters for the 3600 s pulse duration required by ITER. The MeV Test Facility (MTV) at Naka, Japan has the next highest rated performance, but can only test at the 1 A level. The NB test stands being utilized for ITER are given in Table 3.d.2-1, with some of the lower voltage positive ion based source tests stand identified at the bottom of the table.

*Table 3.d.2-1*

*Neutral Beam Test Stand Facilities*

<b>Facility (Country, Lab)</b>	<b>Capability</b>	<b>Main Objective and Purpose</b>
<b>Neutral Beam Test Stands</b>		
ITER NB Test Stand (EU, Padova)	HV power supply (1 MV, 40 A) cw - 180 kW RF power supply, cw	Long pulse full power test of ITER ion source (proposed)
MeV Test Facility (MTF) (JA, JAEA Naka)	HV power supply (1 MV, 1 A) 60 s HV power supply (500 kV, 22 A) 10 s	mainly for voltage holding tests of pieces to be assembled in the HV bushing.
MANITU (Multi Ampere Negative Ion Test Unit) (EU, Padova)	- HV power supply (35 kV, 50 A) cw - 180 kW RF power supply, cw - 2 cryo pumps (2x 350000 l/s)	A long pulse test facility for the IPP RF source. To test NB mock-ups
BATMAN (Bavarian Test Machine for Negative Ions) (EU, IPP Garching)	- HV power supply (30 kV, 40 A) 4 sec -150 kW RF generator	A short pulse test facility for the IPP RF source.

## Draft FESAC sub-panel report – Do not circulate

RADI (EU, IPP Garching)	Presently no extraction foreseen, only plasma operation (with Deuterium) -ITER-like RF circuit -Large size extraction system planned	A source test facility designed to test the plasma homogeneity of a large RF source
The 1 MV test bed (EU, CEA)	HV power supply (1 MV, 0.1 A) 2 s	Is designed principally to test the SINGAP 1 MV negative ion accelerator.
<b>Test Stands for Positive ion Based Sources</b>		
NB Test Bed (EU, JET)	HV power supply (140 kV, 60 A) 2 s	(normally operating with positive ions) is available in JET and can also be used for ITER relevant studies,
Neutral Beam Test Stand (IN, IPR)	55kV, 90A H-beam for 10 s facility.	For NB component tests
NBTF (Neutral Beam Test Facility) (KA, KAERI)	- Max. beam extraction energy: 120 keV - Max beam extraction current: 60 A - Pulse length: 300 sec beam species: Hydrogen	long pulse Ion source Test for the Diagnostics of NB system
IREK test facility (RF, Kurchatov Institute)	The main characteristics of IREK are: Beam current up to 70 A Beam energy 40 – 160 keV Time duration ~ 1 min	Constructed as test facility for Ion source testing and qualification.

### 3.d.2.2 Electron Cyclotron Heating and Current Drive Test Facilities

There are basically two technology areas that need to be developed to support Electron Cyclotron Heating and Current Drive in present day fusion devices, and future programs on the path to Demo. First is the development of high power microwave sources, and the second is the development of in-vessel launchers (mirrors) that can survive the harsh environment of high performance plasma and large neutron fluences.

Presently the microwave source used in fusion experiments is the gyrotron, which has a high unit power (>1 MW), high frequency (170 GHz), can operate for extended time (400 s to cw), and has a reasonable efficiency (~50%). Gyrotrons, being electron tube devices, are easily developed and validated using test stands, which incorporate HV power supplies and water-cooled loads. However, until recently, fusion experiments only pulsed for a few seconds at a time, thus the test stands built for gyrotron validation were only configured for similar short pulse lengths. With the advent of ITER some of the test

## Draft FESAC sub-panel report – Do not circulate

stands were upgraded to longer pulse length (~cw) with the test stand at Naka, Japan having the most capability to date, but the test stand being built at CRPP, Lausanne, Switzerland, for ITER gyrotron validation, with its 2 MW capability will be able to support both and future gyrotron development. Other MW class gyrotron test facilities are available in Germany, Russia, and the United States. Table 3.d.2-2 lists the parameters of various gyrotron test facilities world-wide.

Presently there are no test stands devoted to the development and validation of ECH mirrors that will be needed for Demo. The information for the design of such mirrors is expected to come from the testing and validation of Demo qualified PFCs (see section 3.d.2.1).

*Table 3.d.2-2*

*World-Wide Gyrotron Test Stands*

Facility (Country, Lab)	Capability	Main objective and purpose
<b>Electron Cyclotron Radio Frequency Test Stands</b>		
RF Test Stand (JA, JAEA Naka)	Gyrotron high power test and conditioning Includes transmission line and ECH launcher test area. High power RF component test is available. 80kVx50A, CW (1MW RF is available)	To test gyrotrons and other components for an ECRH system
Gyrotron Test Stand. (EU, CRPP)	Will be equipped with power supplies and cooling capable of energizing 2 MW CW gyrotrons.	Initial use; 170GHz 2MW CW coaxial cavity gyrotron test stand.
Gyrotron Test Stand. (EU, FZK)	Can be used for 1 MW gyrotrons for up to 180 s or for 2 MW for up to 10 s.	To test gyrotrons and other components for an ECRH system
Gyrotron test facility (RF, GYCOM)	1) CW high voltage power supply – $P \leq 23$ A / 70kV CW cooling and measurement systems. Will be available from Oct. 2007. 2) Characterization of microwave parameters of CVD diamond windows ( e.g. loss tangent at various frequencies and temperatures)	To test gyrotrons and other components for an ECRH system
Gyrotron test facility (RF, Kurchatov Inst)	CW high voltage power supply - $P \leq 4$ MW. Vacuum line gyrotron – load. Water cooling system (200m <sup>3</sup> /h). Diagnostics of all gyrotron parameters will	To test gyrotrons and other components for an ECRH system

## Draft FESAC sub-panel report – Do not circulate

	be available. Will be available to the end of 2007.	
ECH Development test facility (US, ORNL & GA)	High power test equipment (power supplies, gyrotrons, waveguide) for ECH development testing	To test gyrotrons and other components for an ECRH system
Gyrotron Test Facility (US, CPI)	1) CW Gyrotron Test Stand, $V \leq 125\text{kV}$ ; $I \leq 25\text{A}$ , including high power load and diagnostics; currently under improvement to achieve higher current capability 2) Characterization of microwave parameters of CVD diamond windows up to 300 GHz.	To test gyrotrons and other components for an ECRH system
<b>Other ECRH Testing Systems</b>		
ECH test facility (US, MIT)	Capability to test very low loss waveguides and components up to 220 GHz	Low Power test of prototype components for an ECRH System
Microwave Development Lab (US, ORNL)	Low power test equipment for ICH, ECH and Diagnostic testing and development	

### 3.d.2.3 Ion Cyclotron Heating and Current Drive Test Stands

Ion Cyclotron Heating uses RF waves in the broadcast range of frequencies of 30 to 120 MHz. The RF sources used for fusion research thus are basically broadcast electron tubes that have been enhanced for higher power operation than used for normal commercial radio and television transmitter stations. In fact under US fusion technology development funding a 2 MW 30 to 120 MHz, cw tetrode was developed that is now the standard transmitter tube used in the US fusion program and is the tube of choice for ITER. Even though the RF source is developed there are still technological issues that need to be solved and validated for any high power Ion Cyclotron Heating System to be used on future fusion research devices. These issues arise from the situation that there is a dynamic interaction between the fusion plasma and the RF launcher (antenna), and the coupling system (transmission line and tuners) that is needed to optimize the power delivery to the plasma. Historically test stands have been developed to address these issues individually, with the final system integration being performed at the fusion device site where the auxiliary support systems are available,

Even though ITER will establish and demonstrate the technology needed for reactor level ICH systems, the results may indicate that the standard strap antennas do not have the coupling efficiency and performance needed for Demo, let alone that the antenna will have to be constructed from materials that can survive the high performance fusion environment. It is anticipated that the present and planned test stands shown in table 3.d.2-3 will provide most of the validation needed for Demo, other than the validation of

## Draft FESAC sub-panel report – Do not circulate

the compatibility and robustness of the antenna system within the fusion nuclear environment. It is also possible that new test stand capabilities will need to be developed if testing of alternate antenna concepts is not compatible with these test stands facilities.

*Table 3..d.2-3*

*Ion Cyclotron Test Stands*

Facility (Country, Lab)	Capability	Main Objective and Purpose
<b>Ion Cyclotron Radio Frequency Test Stands</b>		
High power CW ICRF test facility (EU, CEA)	RF voltage 55 kV, RF current 1.8 kA,	To test ICH prototypes and scaled down components
IC H&CD High Power test bed, (IN, IPR)	3MW (40-55MHz) RF power (1000S) Components can be tested on matched and mismatched dummy load.	For transmission line and related Components Facility likely to be available by late 2011.
ICRF Test Stand (KA, KAERI)	- RF source: 300 kW at f=27-55 MHz - Test chamber: 1.5 m x 1.5 m x 1 m box-type chamber attached with an antenna port - Vacuum pumping system: 200 l/s Diagnostics: IR camera, network analyzer etc. Magnet field: to be installed	-Load resilient Test using salty water Load -Antenna conditioning Test with plasma and magnetic field
(Radio-Frequency Test Facility- Transmission Line) RFTF-TL (US, ORNL)	Equipment: Steady-state RF source 40-80 MHz, 1.5 MW Resonant ring/line test facility with replaceable section in which transmission line or components to be tested can be inserted Network analyzers and other RF diagnostic equipment	Capability to test coax lines, matching components, power splitters, and switches for voltage hold-off , adequate cooling, choice of materials, and reliability
RF Test Facility (US, PPPL)	Two 1.25 MW steady state RF sources 30 MHz +180 degree hybrid combiner	Capability to test of RF source power combination scheme for ITER antenna with 8 feed lines

## Draft FESAC sub-panel report – Do not circulate

### 3.d.2.4 Lower Hybrid Current Drive

Lower Hybrid Heating Systems operate in the RF frequency range of 2 to 10 GHz. The traditional source of the RF power has been high power Klystrons, typically with a unit power of 500 kW. The Klystrons used in fusion experiments found their genesis in the High Energy Physics arena and were modified by their manufactures to transition from a pulsed mode to a continuous operation mode. Most validation testing was performed at the manufacturer’s site so few test stands were needed. The only test stand dedicated to Lower Hybrid systems is at the CEA facility in Cadarache, France (see Table 3.d.2-4).

It is anticipated that when the need for Lower Hybrid becomes is authorized for either ITER or the other next generation fusion experiments that additional test stand facilities will be needed. In particular to address the validation of the launcher system, which is very challenging, because of the need for close wave-plasma coupling and the harsh environment and heat loads.

*Table 3.d.2-4*

*Lower Hybrid Test Stands*

Facility (Country, Lab)	Capability	Main Objective and Purpose
<b>Lower Hybrid Frequency Test Stands</b>		
The Tore Supra Lower Hybrid test bed	3.7 GHz Klystron, 750 kW, 60 s HV Power supply (100 kV, 23 A) 1000 s. 500 kW Dummy Load	

### 3.d.3 Fueling and Exhaust

Present day fusion experiments and those planned for the near future depend on a combination of gas puffing and high speed pellets of frozen fuel to maintain the proper density in the core of the plasma. The US has lead the development of high speed pellet fueling, with most facilities that utilize pellet fueling obtaining their hardware or technology from the Oak Ridge National Laboratory, ORNL (see table 3.2.3-1). However there could be a limitation on pellet penetration (using present day technology), and new concepts with higher velocities may have to be developed, which will require new facilities or modification to the facility at ORNL.

For exhaust control, no dedicated facility is envisioned, however some form of technology development and validation will be anticipated, but should easily supported at most laboratories.

*Table 3.d.3-1*

*Fueling Test Stands*

Facility (Country, Lab)	Capability
<b>Fueling Test Stands</b>	

## Draft FESAC sub-panel report – Do not circulate

Pellet Injector Laboratory (US, ORNL)	Pellets in H and D up to 5 mm, velocities > 1000 m/s, adequate space for prototypical ITER guide tube geometry
--	---

### 3.d.4 Magnet Technology

It is well understood that the performance and economics of Magnetic Fusion Energy is highly leveraged by magnet technology. Thus there will be a continuous need to explore improvements in superconducting magnet capability (e.g. higher fields, higher tolerance to neutrons, lower manufacturing costs, etc.) as well as adapting the latest improvements in strand technology and new high temperature superconducting material, HTSC. During the development phase the test stands listed in Table 3.d.4-1 should be sufficient to explore the next generation of magnet development through the strand validation phase. It is only when magnet development needs to actually validate a complete coil that existing test stands may not have the required capability, and a new test stand, or modification to an existing test stand will have to be constructed.

*Table 3.d.4-1*

*Magnet Development Test Stands*

Facility (Country, Lab)	Capability
<b>Coil Test Stands</b>	
CS Model Coil Facility (JA, JAEA)	13 T 1.6 m bore size
Magnet Test Facility (CN, ASIPP)	A helium refrigerator is used to cool magnets and liquefy helium which can provide 3.8-4.5K, 1.8-5bar, 20-40g/s supercritical helium for coil or 150 liter/hr liquefying helium capability. A large vacuum vessel (3.5m diameter and 6.1m height) with liquid nitrogen temperature shield, two pairs of current lead, two kinds of 14.5-50KA power supply with fast dump quench protection circuitry, data acquisition and control system, vacuum pumping system and gas tightness inspecting device.
<b>Strand or Conductor Testing</b>	
CWTX (USA, NHMFL)	This magnet is a nearly cryostable, NbTi magnet capable of providing 8 T on a conductor sample in its 380 mm cold bore. Sample configuration can be either a loop in the bore or a straight piece fit through the magnet's 67 mm radial-access port.
SMES CTA Magnet (USA, NHMFL)	This magnet can apply up to 4 T to a 2 m diameter loop of test conductor and is also



## Draft FESAC sub-panel report – Do not circulate

	designed for operation as part of a 50 MJ SMES system. The sample volume of the SMES-CTA cryostat provides full thermal isolation from the magnet vessel and can be operated over a full range of temperatures from LHe to room temperature.
Oxford Split Solenoid (USA, NHMFL)	This magnet is designed to produce 14 T in its 150 mm diameter high field region, which accepts large, straight conductor samples through a 30 mm x 70 mm radial-access port. The inner wall of the Oxford cryostat is designed as a compression tube capable of safely transmitting 250 kN mechanical loads and is equipped with remotely actuated pin-and-clevis at the bottom for attaching samples for cold, mechanical testing.
Nb <sub>3</sub> Sn and NbTi test Facility (CN, ASIPP)	Cryogenic 14/16 T - Bore size: 70 mm - Max field: 14.8 T at 4.2 K and 16.5 T at 2.2 K - Homogeneity over 32 mm diameter and ± 17.5 mm axially about field center: 0.5% Central homogeneity over 10 mm dsv: 0.1% - Variable temperature insert with 45 mm sample space, 2 K- 300 K
Cable and Conductor Test Facility (CN, ASIPP)	The facility features a DC background field up to 10T in a 338mm useful bore diameter.
Sultan Magnet System (EU, CRPP)	Forced flow superconducting windings generate a background field up to 11 T. A superconducting transformer supplies the test sample with operating current up to 100 kA. A set of pulsed coils generates a transverse, time varying field (amplitude up to 4 T, field rate up to 65 T/s). Besides vertical access for short, straight conductors, the facility provides horizontal access for long, coiled conductors in the 580 mm bore of the magnets.
Twente Cable Press and Dipole (EU, Univ. Twente)	The Twente Cable Press, produces a variable (cyclic) transverse force of up to 700 kN/m and is transferred directly to a cable section of 400 mm length at a temperature of 4.2 K. The AC loss of the conductor, the inter-strand and strand-bundle resistance (R <sub>c</sub> ) in the cable and the associated bundle deformation are examined during mechanical cycling up to 40,000 cycles per sample.
Facility for qualification of Nb <sub>3</sub> Sn and NbTi strands (RF, Bochvar)	cross checking of superconducting properties of the strands

## Draft FESAC sub-panel report – Do not circulate

Inst)	
LIS-12 facility for advanced strand testing, (RF, Efremov Inst)	Max field 12 T, energy of 1.6 MJ
45 T Hybrid Magnet (US, NHMFL)	The outer superconducting coil produces static field of 11 to 12 Tesla, with the rest of the field being generated by water-cooled resistive insert. Bore size diameter with the insert is 32 mm, and with the insert removed is 600 mm.
Pulse Test Facility (US, MIT)	Magnetic Pulse Test Facility (PTF) includes capabilities for sample currents up to 50 kA from a superconducting transformer developed by the University of Twente, magnetic fields up to 6.6 T with ramp rates to +1.5 T/s and -20 T/s, and a cryogenic interface, supplying supercritical helium with flow rates to 20 g/s through each CICC leg at controlled temperatures to 10 K and pressures to 10 atmospheres.
<b>Material Testing</b>	
Cryogenic mechanical test lab (US, NHMFL)	<p>This lab performs a wide variety of tests using mechanical and superconductor systems.</p> <ul style="list-style-type: none"> <li>• Charpy Impact Tests</li> <li>• Component Tests, (Coils, Composites, Mechanisms, etc.)</li> <li>• Critical Superconductor Properties, <math>I_c</math>, <math>T_c</math>, and <math>J_c</math> vs. Strain</li> <li>• Elastic Properties, Young's Modulus, Poisson Ratio</li> <li>• Electrical Resistivity, RRR</li> <li>• Fracture Toughness, Fatigue Crack Growth</li> <li>• Tension, Compression, Fatigue Tests (Loads up to 500 kN at 4K to 100C)</li> <li>• Thermal Expansion/Contraction Tests</li> </ul>
Magnet Development Laboratory (US, Univ Tenn)	Insulation system testing and development
CRYOMAK (EU, FZK)	<p>Capability for mechanical testing under cryogenic conditions of magnet structures (housing, support, coolant inlet, etc.); e.g.,</p> <ul style="list-style-type: none"> <li>• tensile / compression cyclic loading,</li> <li>• fracture mechanics,</li> <li>• thermal expansion &amp; conductivity</li> </ul>

### 3.d.5 Tritium Breeding and Extraction

The ability to breed and extract Tritium must be well in hand before the start of DEMO, since the burn rate in DEMO will consume the worlds supply of Tritium in a matter of

## Draft FESAC sub-panel report – Do not circulate

weeks. Even though ITER will provide a test bed for trying several different concepts for Tritium breeding, there is significant amount of work that must still be performed before a system to be used on DEMO would be qualified and licensable.

The challenge being faced in developing a completely self-sustaining Tritium breeding and extraction system can be broken down into the five following processes: Tritium breeding, in either a solid or liquid medium; Tritium extraction from the breeding medium; gas stream purification; Tritium storage; and Tritium accountability. All of these tasks will have to be performed at a process level an order of magnitude larger than that experienced in ITER. The test stand facilities now being assembled for the Test Blanket Module, TBM, program on ITER, will be useful to extending this technology to the needs of DEMO, probably with upgrades to several of the key facilities. Table 3.d.5-1 lists several of the facilities that are being enlisted to support the ITER TBM program. The table has been organized into facilities that focus on Tritium, He gas cooling loops, and Liquid metal cooling loops. It is inconceivable that the licensing of the critical DEMO fuel subsystem would be granted without a full-scale demonstration, which is only achievable on a Component Test Facility.

*Table 3.d.5-1*

*Tritium Breeding and Extraction Test Facilities*

Facilities Name	Parameters
<b>Tritium Test Facilities</b>	
TRIEX (Tritium Extraction System from LiPb) (EU, ENEA-Brasimone)	Nominal PbLi mass flow rate: 0.2 kg/s (Max. PbLi flow rate: 1 kg/s) PbLi temperature: 500°C Stripping gas flow rater: 5-150 NI/h
CATS (JA, JAEA TOKAI)	Tritium Inventory: 45 g Annual throughput: 2000g Glove box: 10 (2mx1.5mx4m) Experimental Hood: 14 Tritium Cleanup System: 3
YAYOI (fast neutron source reactor) (JA, UNIV of TOKYO)	the neutron flux of $10^8$ - $10^9$ n/cm <sup>2</sup>
Tritium-Flibe permeation experimental apparatus (JA, KYUSHU UNIV)	T < 800 °C
The RITM-F facility (RF, RITM)	Medium/fluid of model irradiation - He-Ne mixture Pressure - 0.04MPa Tritium purge-gas - Ne+1% hydrogen Pressure - 0.01–0.2MPa Flow rate - 0–10 l/day

## Draft FESAC sub-panel report – Do not circulate

	Channel heating-up temperature - 490 K Maximal neutron flux density: thermal – $5 \times 10^{14} \text{ cm}^{-2} \times \text{s}^{-1}$ fast ( $E > 0.1 \text{ MeV}$ ) – $2 \times 10^{14} \text{ cm}^{-2} \times \text{s}^{-1}$
STAR (Safety and Tritium Applied Research) including TPE (Tritium Plasma Experiment) (US, INL)	15000 Ci Tritium inventory Hazardous Materials Capability 400 m <sup>2</sup> of working area, various diagnostic systems available
<b>Gas Cooling Loop Test Facilities</b>	
High temperature He Experiment Loop (HTHEL) (CN, SWIP)	500-700 °C and 8-10 Mpa
HeFUS3 (EU, FZK)	Q = 0.35 kg/s, 530°C, 10.5 MPa (upgraded up to 1.4 kg/s with a new He circulator)
HELOKA (Helium Loop Karlsruhe ) (EU, FZK)	Q = 1.4 kg/s, P = 10 MPa, Tmax = 550°C
<b>Liquid Metal Cooling Loop test Facilities</b>	
Liquide metal test loop (LMTL) (CN, SWIP)	B <sub>max</sub> =2.0T, 140x80x1000mm <sup>3</sup> ; EM Pump 6+11m <sup>3</sup> h <sup>-1</sup> Temperature 100C; work mass (Nak), GaInSn
Thermal convection LiPb loop (CN, ASIPP)	500~1000°C
PbLi EBBTF loop (EU, FZK)	Q <sub>max</sub> PbLi = 1.1 m <sup>3</sup> /h T <sub>min</sub> /max PbLi = 300/550 °C
F <sub>TPP</sub> (JA, JAEA NAKA)	T = up to 700 °C P= 10 <sup>-3</sup> – 200 kPa He Test volume = 0.265 l Test stress = up to 10MPa
LiPb loop (JA, KYOTO Univ)	LiPb inventory : 6 liter Flow rate : 0 – 5 liter /min; Loop temp. : 250 – 400 °C Test Section: up to 900°C, RAFM, SiC/SiC Test Item: - hydrogen permeation, transfer, monitoring and recovery process study -heat transfer test with LiPb and He planned in 2006. -MHD measurement started.
TNT (Tohoku-NIFS Thermofluid) loop for molten salt (JA, TOHOKU UNIV)	u = 8 ~ 20 L/min; T < 600°C; V ~ 0.1m <sup>3</sup> ; P < 0.7 MPa
Li TBM test facility (RF, EFREMOV)	Li temperature up to 550°C, Li volume ~50 l

## Draft FESAC sub-panel report – Do not circulate

MTOR Lab (Magneto-Thermostat Omnibus Research) (US, UCLA)	1.5 l/s, 150C, Ga-In-Sn Flowloop 1 T 80 cm ID Magnetic Field Facility 2T, 120 x 15 x 15 cm, Magnetic field facility 1 l/s, 500C, PbLi flow facility (Planned)
LIMITS (Lithium Loop) (US, SNL)	70 liter loop (furnace and centrifugal pump) 180-220°C typical with Li, 425°C capability 0.6T field, shaped fields to simulate NSTX Glove box for handling lithium Electron beam heating heat (no B field)
DELTA loop (US, LANL)	Forced convection loop, 0.4 l/s and natural convection 0.05 l/s, up to 550 C, Material of construction 316L,
ORNL Thermal Convection Loop Facility (US, ORNL)	Current work with FLiNaK salts at $\leq 800^{\circ}\text{C}$ with $\text{DT}=150^{\circ}\text{C}$ and 1m/min flow rate Vacuum chamber for vanadium or other refractory metal testing

### 3.d.6 Remote Handling

An underlying theme to making DEMO a success is that it is to have a high availability. This means that the components of DEMO need to be robust and dependable. Additionally, if and when there is a need to change or repair components within DEMO, the changes must be performed quickly, efficiently, and achieve the same level of robustness and dependability as the original installation, and all of the work has to be performed remotely. To achieve this level of sophistication will require that remote handling be integrated into the design of the components at an early stage; and that advanced remote handling tooling that can cut, weld, remove, reweld, and inspect, be developed and validated on dedicated test facilities.

Historically, remote handling test facilities have been assembled by the research programs, as required to meet the needs of their program. To this end, remote handling R&D was performed on ITER, but it was focused on satisfying the needs of ITER, which has different objectives than DEMO. Regardless, the lessons learned on ITER are a good starting point for DEMO, and the test stand facilities used for ITER, see table 3.d.6-1, can be utilized to investigate the remote handling concepts for DEMO.

*Table 3.d.6-1*

*Remote Handling Test Facilities*

Facility (Country, Lab)	Capability
<b>Remote Handling</b>	
Divertor Test Platform 2 (EU, VTT)	Mock-up facility to test Divertor RH equipment (Movers, end-effectors and tooling), demonstrates the major elements of the ITER divertor exchange process
Divertor Refurbishment Platform (DRP)	Mock-up facility to test methods and equipment for Divertor RH refurbishment in the Hot Cell

## Draft FESAC sub-panel report – Do not circulate

(EU, ENEA Brasimone)	(Hot Cell workstation, component handling devices and tooling).
Remote welding and cutting robots (US, ORNL)	Two complete track mounted, 5 axis robots with integrated narrow gap TIG welding heads developed during ITER EDA for remote welding/repair of vacuum vessel
SRIIAR (RF, SRIIAR)	Tests of prototypes of remote handling (RH) equipment including hot cell processing in hot cells of SRIIAR

### 3.d.7 Power Supplies

Magnetic Fusion Facilities need a wide variety of power supplies from high current units for magnets to high voltage units for auxiliary heating systems. The power supplies are typically custom engineered for each application, but are based upon technology well developed in commercial power supply applications. The main differences of fusion based power supplies from typical commercial applications, is the large unit powers needed, with corresponding issues on energy loss management, as well as insulation issues with high voltages, and mechanical stresses resulting from the large currents delivered to the load. Since most, if not all, of the power supply manufactures do not have in house facilities for complete factory acceptance testing, the final acceptance testing can only be on site, were there is sufficient source power and auxiliary equipment.

It is possible that new power supply technology will be developed that may have a promising application to fusion power supplies, that would make them perform better, have higher efficiency, lower manufacturing costs, or provide better protection to system faults. Under these conditions it would be prudent to test these new technologies or applications on a test stand. It is very likely that the test stands listed in Table 3.d.7-1 will be sufficient to perform the validation tests. If not new facilities will need to be constructed.

*Table 3.d.7-1*

*Power Supply Test Stands*

Facility (Country, Lab)	Capability
<b>Power Supply Test Stand</b>	
Power Supply Test Facility (CN, ASIPP)	110kV/85MVA substation 100MW/400MJ AC flywheel generator, 4 sets of DC flywheel generator, each set is 50kA/500V/140MJ, and they can be in parallel or in series. AC/DC converter: $I_{DC}=100kA$ , $V_{dc}=350V$ , continuous operation.
Test facility UTFED (RF, TRINITI)	The facility was designed for testing, qualification and certification of high power circuit-switch-off apparatus in wide spread parameters of current, voltage and time duration. Current – 10-500 kA; Voltage – up to 40 kV

## Draft FESAC sub-panel report – Do not circulate

	Time duration <1 min UTFED can be used for test switch-off apparatus up to power $10^{11}$ W
--	--

### 3.d.8 Structural Materials

There are five main categories of test facilities that will be utilized for the development of structural materials for Demo. These facility categories are irradiation facilities, physical and mechanical property test facilities, microstructural characterization facilities, corrosion facilities, and materials joining facilities. It is anticipated that fusion will continue to utilize the multibillion dollar investments by non-fusion agencies in advanced materials characterization facilities. These include neutron scattering characterization at the Spallation Neutron Source (SNS) and the High Flux Isotopes Reactor (HFIR) and X-ray scattering characterization at the Advanced Photon Source (APS), all of which are funded by BES, small angle neutron scattering facilities at NIST sponsored by the Department of Commerce, and electron microscopy national user centers sponsored by BES and DOE-EERE.

#### 3.d.8.1 Irradiation facilities

The fusion materials program has utilized numerous irradiation facilities built and maintained by BES, NE or NNSA funding, and it is anticipated these facilities will continue to be beneficially used to investigate fundamental radiation effects phenomena in the future in order to pave the way to Demo. These facilities include ion beam irradiation facilities at ANL, LANL and PNNL that are useful for single-effects studies of microstructural changes in materials associated with displacement damage, numerous gamma irradiation facilities located at national laboratories and universities, and fission neutron reactors that can accommodate a wide variety of specimen geometries to extract comprehensive mechanical and physical property changes associated with fission neutron damage. Most of the fusion materials neutron irradiations have utilized the BES-supported HFIR facility. A few irradiation tests over the past 15 years have also utilized the NE-supported Advanced Test Reactor (ATR). Both of these test reactors have a replacement cost in excess of 1 B\$, and have an annual operating budget in excess of 50M\$. The key operational parameters of the ion and neutron irradiation facilities are summarized in Table 3.d.8-1. Typical capsule volumes in HFIR and the higher flux irradiation positions in ATR are 100 to 700 cm<sup>3</sup>, and achievable displacement damage rates are typically 5 to 15 dpa per year.

The proposed International Fusion Materials Irradiation Facility (IFMIF) is intended to satisfy the dual purposes of (a) science-based investigation of materials behavior in fusion-relevant environment (i.e., acquire experimental data including fundamental constitutive mechanical properties essential for model-based development of radiation-resistant materials) and (b) developing experimental database on structural materials needed to license a fusion demonstration power plant reactor and to provide robust engineering confidence for its structures. Since the physics of defect migration and

## Draft FESAC sub-panel report – Do not circulate

accumulation are strongly affected by He in a complex manner (which in turn modifies the microstructural evolution), current models are unable to extrapolate results obtained from the low He/dpa regimes associated with fission reactor irradiations to the fusion-relevant regime. A fusion-relevant irradiation facility is needed to guide the development of new predictive models. Due to the physics of deformation and fracture, experimental testing of radiation damage in a fusion material at a given temperature requires an intense neutron source with the substantial test volumes ( $\gg 10 \text{ cm}^3$ ) and modest neutron flux gradients ( $< 10\%/cm$ ) that could be achieved in a dedicated facility such as the proposed IFMIF. The design parameters for IFMIF are summarized in Table 3.d.8-1.

Considering the long time that will be required to complete the detailed engineering design and to construct IFMIF, the question has arisen whether accelerator-based spallation neutron sources can provide insight on the microstructural evolution of materials at fusion-relevant He/dpa levels. A Materials Test Station (MTS) design proposed by LANL utilizing the LANSCE facility would enable damage levels up to 18 dpa/year at 5 to 25 appm He/dpa in an irradiation volume approximately one-half that of IFMIF. Similar irradiation parameters might be achievable from a dedicated test station at the beam dump region of the Spallation Neutron Source. Utilization of such a spallation neutron facility might accelerate the development of fusion materials and could reduce or potentially eliminate the need for US participation as a full partner in IFMIF.

*Table 3.d.8-1. Summary of the proposed IFMIF and Existing Ion and Neutron Irradiation Facility Parameters (He/dpa values are for ferritic steel; maximum 4 year irradiation assumed for the fission reactor max doses). The number of irradiation positions for ATR and HFIR are listed under the comments column.*

Facility (DOE funding agency)	Irrad. Temp. (K)	Max dose (dpa)	appm He/dpa ratio	Irrad. volume	Comments
LANL Ion Beam Materials Lab (BES)	80-1370	>100	Wide range	~1 $\mu\text{m}$ depth by 3 mm diam	0.2-20 MeV ions; simultaneous dual beam; NRA, RBS, PIXE, ERDA
PNNL EMSL Ion Beam Lab (BER)	130-1300	>100	0	~1 $\mu\text{m}$ depth by 3 mm diam	0.2-10 MeV ions; single beam; NRA, RBS, ERDA
ANL IVEM Tandem facility (BES)	15-1200	>100	0	~1 $\mu\text{m}$ depth by 3 mm diam	In-situ TEM observation capability; single ion beam
HFIR (BES)	330-1800	~70(T) ~20(RB)	0.2	50x1.6cm diam 50x4.3cm diam	T: target region(37); RB: RB position(8)
ATR (NE)	370-1300	30 30	0.2	120x1.6cm diam 120x7.6cm diam	A, H positions(30); EFT position(1)
IFMIF	520-1300	200 80	10	500 $\text{cm}^3$ (H) 6 liter (M)	H: high flux module; M: medium flux mod.



### 3.d.8.2 Microstructural characterization facilities

Substantial investment in world-leading materials characterization facilities has been made by several US government agencies. These facilities range from synchrotron and neutron scattering national user facilities sponsored by BES or the Department of Commerce (APS, SNS, HFIR Center for Neutron Scattering, NIST reactor) to several advanced electron microscopy national user centers sponsored by BES (SHaRE user facility at ORNL, electron microscopy user centers at LBNL and ANL, and various user centers at Universities) or EERE (High Temperature Materials Lab user center at ORNL), and atom probe characterization associated with the SHaRE facility at ORNL. With appropriate procedures, most of these facilities can be used for examination of neutron irradiated materials. Numerous additional materials characterization facilities are available for potential investigations of fusion materials at a wide number of US institutions.

### 3.d.8.3 Physical and mechanical property test facilities

Several different categories of physical and mechanical property test facilities are currently available in the US. For highly irradiated radioactive specimens, testing of most key mechanical and physical properties can be performed in dedicated hot cell facilities such as the Irradiated Materials Examination and Testing (IMET) facility at ORNL. Capability for mechanical property testing of specimens currently exists in several national laboratory facilities, including PNNL INL and LANL. Specimens with reduced levels of radioactivity can be tested in specialized hot laboratory facilities such as the Low Activation Materials Development and Analysis (LAMDA) facility at ORNL. Finally, if the specimen radioactivity is sufficiently small, testing in general purpose laboratories can usually be performed in national laboratories and some universities by temporarily creating a radiological area within the testing lab.

### 3.d.8.4 Corrosion test facilities

The US capabilities for corrosion testing using liquid metals such as Pb-Li or Li is greatly reduced compared to the 1960s where dozens of institutions were performing hundreds of corrosion loop tests on a variety of coolants and structures. Some investment by DOE will be needed to reestablish an appropriate level of experimental capability (perhaps in conjunction with DOE-NE, depending on the future of proposed Generation IV fission reactor research activities, some of which utilize coolants that have some similarity to fusion-relevant coolants, e.g., Pb-Bi, Na alkali metal, and high temperature helium).

### 3.d.8.5 Joining research facilities

Funding for joining research in the US has dropped precipitously over the past twenty years. As a result, there is a danger that aging equipment currently occupying lab space at national labs and universities may be discarded in the near future. Investment by DOE

(again, perhaps in conjunction with DOE-NE in association with the Generation IV fission reactor program) will be needed to maintain and enhance the current capability for joining. There are several new joining techniques such as friction stir welding that should be considered for sustained funding to determine their applicability for joining complex fusion structures.

### 3.e. International Fusion Development Plans

#### 3.e.1 U.S. Fusion Development Planning

A roadmap for fusion development in the U.S. was laid out by a recent FESAC panel [3.e.1.1] but has not been adopted as official policy. In that plan, Demo is the last step before commercialization of fusion energy. Demo must provide power producers with the confidence to invest in commercial fusion as their next generation power plant, *i.e.*, demonstrate that fusion is practical, reliable, economically competitive, and meets public acceptance. In addition, Demo must operate reliably and safely on the power grid for long periods of times (*i.e.*, years) so that power producers gain operational experience. The top level goals for the U.S. Demo [3.e.1.1] are summarized below:

##### Integration and Scalability to a Commercial Power Plant:

1. Use the physics and technology anticipated for the first generation of commercial power plants as an integrated system
2. Be of sufficient size for confident scalability (>50%-75% of commercial).

##### Reliability

3. Demonstrate robotic or remote maintenance of fusion core.
4. Demonstrate routine operation with minimum number of unscheduled shutdowns per year.
5. Ultimately achieve an availability > 50% and extrapolate to commercially desired levels.

##### Safety and Environmental Impact:

6. Not require an evacuation plan.
7. Generate only low-level waste.
8. Not disturb the public's day-to-day activities.
9. Not expose workers to a higher risk than other power plants.
10. Demonstrate a closed tritium fuel cycle.

##### Economics:

11. Demonstrate that the cost of electricity from a commercial fusion power plant will likely be competitive.

The U.S. Demo must use and demonstrate the same technologies that will be incorporated in a fully-commercial power plant. This requirement is fundamental in determining the features of the Demo and may or may not be adopted by other countries in their definition of a Demo." If the basic technologies are changed following the Demo, then another Demo must be built before the design and construction of the commercial plant. A private investor will not accept risk of failure or reduced performance due to

## Draft FESAC sub-panel report – Do not circulate

unproven and undemonstrated technologies. Additionally, it may be impossible to insure and/or license such a plant.

This requirement allows for the performance levels to be reduced from a fully commercial plant as specified in the remaining Demo requirements. For example, a reduced level of thermal efficiency, availability and component lifetime in the Demo (owing to less competitive cost of electricity) allows the components to be designed slightly different and operate at lower temperatures and stresses. There is no requirement that specifies the component operating conditions must be exactly prototypical. However, through operation of the Demo, a high level of confidence must be gained so that the first commercial plant is assured to meet the more stringent commercial power plant requirements. If performance levels are reduced from that of a full commercial plant, then the ability to extrapolate must be clearly demonstrated.[ 3.e.1.2]

### International Demo Characteristics

The international partners presently involved in the construction of ITER have carried out a number of technical studies of the requirements for a fusion power plant. The goals for the various international fusion power plants vary significantly, mainly in the degree of economic competitiveness that must be achieved in the first generation of power plants. The US Advanced Reactor Innovation Evaluation Studies (ARIES) [3.e.1.3] and the European Power Plant Conceptual Studies (PPCS) [3.e.1.4] have examined a range of possible power plants that include systems with modest extrapolation in physics and technology to systems with advanced physics and technology that illustrate the ultimate performance of fusion power plants. These studies of potential power plant help identify the key issues that a Demo must address and give a range of physical parameters that provide a useful measure in assessing the extrapolation from today's knowledge base to that required for Demo.

*Table of Typical Parameters for Fusion Power Plants Compared to ITER*

	ITER-H	ITER-AT	ARIES-I'	PPCS-A	ARIES-AT	PPCS-D
R(m)/a(m)	6.2/2		8/2	9.5/3.2	5.5/1.3	6.1/2
B(T),	5.3	5.1	9	7	6	5.6
I <sub>p</sub> (MA)	15	9	12.6	30	11.3	14
I <sub>ext-CD</sub> (%)	0	50	43	55	9	23
P <sub>elect</sub> (MW)	0	0	1000	1550	1000	1530
P <sub>fusion</sub> (MW)	500	350	2000	5000	1760	2530
Q <sub>plasma</sub> , Q <sub>eng</sub>	10, <1	5, <1	25, 3.4	20,	45, 7.1	34,
β <sub>N</sub>	1.8	2.8	2.9	3.5	5.4	4.5
Γ <sub>n</sub> (MWm <sup>-2</sup> )	0.5	0.4	1.5	2.2	3.3	2.4
Pulse Length	400s	3000 s	Steady	Steady	Steady	Steady
Availability,%	~5	~10	80	75	80	75
Fluence (dpa)	0	0.3	150	150	150	150
Breeder Matl	Test	Test	Solid Li	LiPb	LiPb	LiPb
TBR	≈ 0	< 0.01	1	1.06	1	1.12

## Draft FESAC sub-panel report – Do not circulate

Coolant	water	water		Water	LiPb	LiPb
Opting T(°C)	150	150	600	167	1000	990
Struct Matls	Sta Steel	Sta Steel	SiC	Ferr Steel	SiC	SiC
Remote Maint	In Vess	In Vess	Sector	In Vess	Sector	In Vess

Direct extrapolation from ITER physics and technology characteristics would yield a very large power plant with non-competitive economics. The table above illustrates improvements needed for an entry-level power plant (ARIES-I', PPCS-A) and the ultimate performance (ARIES-AT, PPCS-D) that could be attained using both advanced physics and technology.

In the U.S, the fusion Demo is viewed as a prototype for an economically competitive fusion power plant and is expected to operate with the technologies of a fusion power plant, and with parameters approaching those anticipated for a power plant. In the EU, the fusion Demo is viewed as a roll-forward step with modest extrapolations beyond ITER. The EU Demo would typically lead to a first generation fusion power plant with less competitive economics. Recently, the EU has undertaken a study of Demo including the possibility of an early Demo with reduced requirements [3.e.1.5]. Given this difference, one might expect more than one Demo to be built with generic characteristics similar to those listed below.

### High Level Characteristics for Demo

- Materials for PFCs and Blankets that are candidates for 1st Power Plant
- Significant fusion power  $\sim 1 \text{ GW}_{\text{th}}$  at moderate  $Q \sim 15, \Gamma_n > 1 \text{ MWm}^{-2}$
- Closed fuel cycle - Tritium breeding with  $\text{TBR} \approx 1.0$  (this goal that must be accomplished)
- “Steady state” operation with moderate  $f_{\text{bs}}$  and  $\eta_{\text{CD}}$  (pulses  $\sim$  week duration at beginning, month long near end)
- Reasonable availability approaching 50% after 10 years
- Heat extraction at reasonable  $\eta$  to produce electricity

### References

- [3.e.1.1] FESAC - 35 year Plan, 2003
- [3.e.1.2] Starlite , U.S. Fusion Demo Power Plant, ANL/FPP-87-1, 1992
- [3.e.1.3] ARIES
- [3.e.1.4] EU Power Plant Conceptual Studies (PPCS)
- [3.e.1.5] EURATOM Study on Early Demo

### 3.e.2. EU Fast track Plan

Beginning in 2001, scientists in the EU have mapped out a “Fast Track” plan for development of fusion energy [3.e.2.1,2]. The endpoint is electricity generation from commercial fusion power plants approximately 40 years from the go-ahead decision on ITER. The fusion reactor concepts have been discussed in a series of papers and reports.[ 3.e.2.3,4] but has not been adopted as official EU policy.

## Draft FESAC sub-panel report – Do not circulate

The fast track plan represents a top-down strategic view. It is intended as a roadmap and a description of technical feasibility not a prediction or blueprint. An exercise in “bottoms up” planning, design and costing has not been carried out. The reactor options defined in the references mentioned above span a range of physics and engineering options, with decreasing COE and graduated assumptions for advanced plasma operation and materials. Principle physics levers identified were 1) adequate confinement, 2) high  $\beta_N$  3) high  $n_G$ . Principle technology levers involve blanket and divertor performance including the associated materials issues.

The current terminology in the plan seems to align closely with US usage. The last step before commercialization is called Demo (not PROTO). It is important to note however, that in the base case for the fast track plan, Demo has two phases. Only the second corresponds to the definition used in the US Fusion Development Plan report [3.e.2.5] – that is a high-availability, electricity producing, prototype reactor. The first phase roughly corresponds to the US vision for CTF, but its mission would be carried out in the Demo facility.

### **Vision for Demo within fast track plan**

The requirements and mission for Demo are, of course critical elements in the plan. These are summarized:

- Be based on and confirm at higher fusion power, the plasma physics basis developed by ITER and parallel devices.
- Be based on low-activation, long-lifetime materials successfully tested in IFMIF
- Demonstrate the safety and environmental advantages of fusion
- For phase I, Demo must
  - Confirm the first wall lifetimes in simultaneous plasma and neutron fluxes.
  - Provide information on the main problems of materials compatibility and reliability for blankets and divertors to support optimized design for phase II
- For phase II, Demo must demonstrate
  - High availability energy supply for grid
  - High reliability and availability especially of blankets and divertors
  - Long lifetime and compatibility of materials and components
  - Tritium self-sufficiency
  - Costing projections

### **Major elements of plan: “Pillars” and “Buttresses”**

The overall fast track strategy organized around “Pillars” and “Buttresses”. There is a basic assumption from EU studies [3.e.2.3,4] that fusion could be a practical energy source without advanced operations (AT) or major advances in materials. (Note: this is not the consensus in the US.)

These elements are summarized in the following table.

	<b>Pillars</b>	<b>Buttresses</b>
<b>Elements</b>	ITER IFMIF	Existing & Future tokamaks CTF

## Draft FESAC sub-panel report – Do not circulate

	Demo	2 <sup>nd</sup> IFMIF Existing & Future alternates Multiple parallel Demos
<b>Purpose</b>	Minimal set of facilities necessary for commercialization of fusion energy	1. Accelerate timetable 2. Mitigate risks 3. Improve 2 <sup>nd</sup> generation fusion plants
<b>Timetable</b>	High availability Demo in 37 years from ITER decision, 1 <sup>st</sup> commercial plant 6 years later	Saves ~ 4 years from baseline (aggressive) plan (buttresses could lower schedule risk)
<b>Background</b>	EU studies [3.e.2.3,4] conclude that fusion could be practical energy source without advanced modes of plasma operation or major materials advance.	Same study shows significant decrease in COE with advanced operations and materials
<b>Requirements</b>	ITER and IFMIF must focus almost exclusively on Demo issues. (Early DT operation on ITER is important)	Parallel efforts, higher funding levels
<b>Notes</b>	Without buttresses, Demo has two phases, only phase II corresponds to US vision for Demo.	With CTF, plan goes directly to high-availability Demo

### Pillars - Main steps in Fast Track plan

1. Operation of current large tokamaks
2. Immediate start to ITER
3. Design and build IFMIF as soon as possible
4. Agreement on main features and choices for Demo
5. Prioritization of ITER and IFMIF operation to support Demo
6. Provisional design of Demo as ITER and IFMIF results are available
7. Construction of Demo as soon as licensing is possible

### Buttresses - role and examples

- Accelerate schedule
  - Existing and planned tokamaks speed up and maximize scientific return from ITER
  - 2<sup>nd</sup> IFMIF speeds materials qualification
  - CTF allows full test of blanket modules before Demo
- Reduce risk
  - 2<sup>nd</sup> IFMIF allows wider range of materials to be tested
  - CTF increases database for Demo design
  - Multiple Demos could test wider range of materials and operational regimes
  - Alternate confinement concepts could avoid tokamak show-stoppers (e.g. disruptions)

## Draft FESAC sub-panel report – Do not circulate

- Improve performance/COE for following generation of reactors
  - Advanced tokamak operation leads to improved reactor, lowered costs
  - Development and qualification of advanced materials
  - Alternates if/as they develop

### Major technical issues identified for program

The following are categories of technical issues that must be solved before commercialization. Any development plan must have a strategy for resolving all of them. In the EU plan, ITER has the major role in resolving 1,2,3,4,5,13,14,16 IFMIF principally deals with 7 & 8, and Demo would be responsible for resolving the rest. The “pillar only“ strategy assumes that all physics issues are resolved by ITER, and that ITER plus the TBM program plus IFMIF are sufficient for blanket design and first wall/divertor design.

1. Disruption avoidance and mitigation
2. Steady state operation – bootstrap and CD, engineering issues
3. Divertor performance – plasma surface interactions, materials, heat removal
4. Integrated burning plasma – control, stability, confinement,  $\alpha$  physics
5. Plasma performance – operating limits, especially pressure
6. Tritium self sufficiency – retention, breeding
7. Materials development – for PFC and structure, good performance under irradiation
8. Materials characterization – for licensing
9. PFC lifetime – survival and replacement
10. First wall/blanket materials lifetime – neutrons, invessel environment, cooling
11. First wall/blanket components lifetime – as above, but including component scale issues, including welding/joining technologies
12. Divertor materials lifetime – similar to PFC, but in different environment
13. Heating and current drive – efficiency, availability
14. Superconducting magnets – control, availability
15. Electricity generation at high availability – integration, reliability, maintenance
16. Remote handling

### Risks and Mitigation

The EU plan gives considerable thought to program and schedule risks. The basic feasibility and advantages of fusion power are assumed, so the risks are either 1) delay or 2) degradation in performance of initial fusion power plants. The most notable risk factors are delays in qualifying suitable materials and in demonstrating tritium self-sufficiency. Risk mitigation is considered via analysis of “risk-adjusted net present value”. The overall conclusion is that, given the assumed advantages for fusion power and the size of the electric power industry, steps to mitigate identified risks can be economically justified, even with radical increases in research expenditures.

### Comparison with US (FESAC) fusion energy development plan

The US plan [3.e.2.5] is characterized by:

- More aggressive vision for Demo, based on advanced operating modes

## Draft FESAC sub-panel report – Do not circulate

- CTF viewed as essential
- Inclusion of IFE on “equal” footing with MFE
- More prominent role for alternate concept development

### **Some Issues/Questions that the EU plan raises for US**

1. What is the impact on the ITER scientific program – fast track plan advocates “industrial” approach, energy mission is explicit and has priority for all facilities.
2. What will be the US access to IFMIF data?
3. Will US have any role in choosing IFMIF materials?
4. Will either of these last two issues constrain US designs for Demo?
5. To what extent are current materials and current operating modes acceptable for reactor?
6. An early CTF is clearly desirable, does it become irrelevant if it comes late?
7. Is a 2-phase Demo feasible or practical? (Do we compromise the ultimate Demo mission?)

### **References**

[3.e.2.1] “Conclusions of the fusion fast track experts meeting held on 27 November 2001

on the initiative of Mr. De Donnea, president of the research council”, EUR (02) CCE-FU/FTC 10/4.1.1, Brussels 5 December 2001 (commonly called the “King Report”).

[3.e.2.2] I. Cook, N. Taylor, D. Ward, L. Baker, T. Hender, “Accelerated Development of Fusion Power” UKAEA FUS 521, February, 2005

[3.e.2.3] I Cook, N P Taylor and D J Ward, “Four near-term and advanced fusion power plants: systems analysis; economics; prime safety and environmental characteristics”, Proceedings of the Symposium on Fusion Engineering, San Diego, Oct. 2003.

[3.e.2.4] D Maisonnier, I Cook, P Sardain, R Andreani, L Di Pace, R Forrest, L Giancarli, S Hermsmeyer, P Norajitra, N Taylor, D Ward, “A Conceptual Study of Commercial Fusion Power Plants: Final Report of the European Power Plant Conceptual Study”. EFDA–RP–RE-5.0, European Fusion Development Agreement, September 2004.

[3.e.2.5] “A Plan for the Development of Fusion Energy” FESAC, March, 2003

### **3.e.3. Japanese Development Plan**

This summary is based on the “National Policy of Future Nuclear Fusion Research and Development” document published on October 26, 2005 by the Japanese Atomic Energy Commission’s Advisory Committee on Nuclear Fusion. The Atomic Energy Commission established the Third Phase Basic Program of Fusion Research and Development in June 1992. The Advisory Committee on Nuclear Fusion wrote their 2005 report as part of a periodic “check and review” called for at the establishment of the Third Phase Program.

The principal subjects covered in the report are:

- Role of fusion in solving energy and environmental problems



## Draft FESAC sub-panel report – Do not circulate

- Position of fusion R&D in the Nuclear Energy Policy
- Check and review of progress of the Third Phase Program
- Development strategy for fusion energy with maximum utilization of ITER
- Role of academic research on fusion (universities and NIFS)
- Training and education of researchers, and securing human resources
- Utilization of international collaborations

The Committee members “expect that this report clarifies the policy to be undertaken in the Third Phase Program, and will become the basic guidelines for future Fusion R&D of our country.”

### **Overall Strategy and Timescale**

Their goal is to begin the practical use of fusion power before the middle of the 21<sup>st</sup> century. That will require successful completion of two phases. The Third Phase, which they are in now, will culminate in the decision to construct Demo. The Fourth Phase will focus on technical demonstration and economical feasibility in Demo. Successful completion of the Fourth Phase will be the decision to begin the practical use of fusion. They recognize that fusion research is a field where Japan “can lead the world.”

### **Demo Characteristics**

Economic feasibility requires Demo to have fusion power densities several times higher than ITER. Demo must operate in a steady-state mode without interruption for at least one year with the following characteristics:

- High plant efficiency
- High output stability
- Tritium breeding ratio  $>1$
- Thermal output of 3-4 GW

These requirements impose stringent requirements on non-inductive current drive systems, and particle and heat control systems. First wall materials must be able to withstand a neutron flux of 10-20 MW-yrs/m<sup>2</sup>, and a heat flux of 1 MW/m<sup>2</sup>. The divertor components have to withstand even higher heat and particle fluxes. Economics also require high plant availability, which impose limits on the frequency and duration of maintenance periods.

### **Decision Criteria for Starting the Fourth Phase (Demo)**

The transition to the Demo phase will require the demonstration or development of the following:

1. Burn control in self-heated regime in ITER.
2. Non-inductive operation of ITER for  $>1000$  seconds with  $Q \geq 5$ .
3. Technology integration on ITER.
4. High-beta steady-state operation method required by economics (National Centralized Tokamak).

## Draft FESAC sub-panel report – Do not circulate

5. Materials and fusion technology relevant to Demo.
6. Conceptual Design of Demo
7. Understanding of fusion commercialization prospects, with participation of the private sector, and the evaluation of progress in fusion research including non-tokamak methods.

### Major Elements of Phase Three

To meet the Demo decision criteria, Phase Three utilizes the following elements:

- Tokamak research using ITER
- Tokamak improvement research, focused on high-beta steady-state operation.
- Development of fusion technologies, including breeding and power generation blankets, structural materials, superconducting magnets, heating and current drive systems (beam and RF), tritium handling and safety systems, and radioactive waste reduction and processing.
- Research on fusion reactor systems, including the conceptual design of Demo.
- Tokamak theory and simulation, including support for ITER (plasma control, data acquisition, and analysis) and for conceptual Demo and reactor designs.
- Societal and environmental safety research to prepare the way for gaining approval for constructing fusion power plants in Japan.
- Helical device research to assess fusion reactor potential and to study high-beta steady-state plasma physics and divertor issues.
- Laser-driven inertial fusion research to achieve ignition and burning plasma conditions.
- Fundamental fusion research using small-to-medium-sized devices, theory and simulation.
- Fusion technology development needed for laser-fusion-based reactor designs.
- Basic research on materials and on fusion technologies.

The major facilities that will be used in Phase Three are:

#### ITER

Fully utilize ITER to demonstrate burning plasma control in the self-ignition regime ( $Q > 20$ ) for several 100 seconds, and in a steady-state mode ( $> 1000$  s) with  $Q > 5$ . It will also establish the technological basis for the integrated operations of superconducting coils, remote maintenance, tritium handling, in vessel components, and small-scale blanket technologies.

#### JT-60

Contribute to international physics activities to improve ITER performance and expand its operational margins. These include studies of confinement (including high energy particles), stability, current drive, and divertor heat and particle control in long-pulse regimes.

## Draft FESAC sub-panel report – Do not circulate

In addition, carry out preliminary R&D on long-duration stable maintenance of high-beta (3.5-5.5) plasmas to establish the scientific basis for Demo. To further this research, the facility will be converted into the National Centralized Tokamak.

### National Centralized Tokamak (JT-60SA)

Explore ways to sustain high-normalized-beta (3.5-5.5) plasmas near breakeven parameters for more than 100 s. It will also seek advances in heating and current drive systems, and aim at a stable operation of high-beta plasmas lasting several hours.

### International Fusion Materials Irradiation Facility (IFMIF)

Study materials in a high-energy neutron environment similar to that expected in a fusion reactor, including the effects of helium and hydrogen produced in materials exposed to such an environment.

### LHD

Explore confinement improvement and contribute to the worldwide effort to optimize 3-dimensional steady-state confinement systems for a reactor-core plasma. Studies will also enhance the general understanding of toroidal confinement.

### FIREX

Use a new high-intensity short-pulse laser in the FIREX first-phase program to achieve ignition temperatures in the fuel compressed by the existing GEKKO-XII laser.

## **Comparison with the US Fusion Energy Plan**

The US FESAC report “A Plan for the Development of Fusion Energy,” March, 2003, represents the most recent expression of the US technical fusion community’s view of what would be a reasonable US fusion energy development plan. However, the US government has not officially adopted that plan, or any other plan, and there are substantial differences between the FESAC plan and what is presently funded by the US DOE. The following list attempts to compare the Japanese plan (J) with the FESAC plan (F), and with what is funded by the DOE.

- J and F have a similar vision of Demo, requiring advanced operating modes. No US or Japanese commitment to build a Demo at this time.
- J and F both view advanced tokamak research as essential. DOE has made no commitment to build a facility similar to the National Centralized Tokamak.
- J and F both view fusion theory and modeling as essential. DOE funding is constrained.
- J does not mention a CTF, but F views CTF as essential.
- J and F view fusion technologies and materials development as essential. DOE funding is highly constrained.
- J and F view fusion system studies, including safety and waste issues, for Demo and reactors as essential. DOE funding is highly constrained.
- J views IFE (lasers) as one of two major approaches to fusion energy other than tokamak (their other major alternate is the helical system), while F views IFE on

## Draft FESAC sub-panel report – Do not circulate

an equal footing with MFE. DOE funds inertial fusion research as part of HEDP, not as path to energy.

- J and F view innovative confinement concepts similarly. DOE funding is constrained.

### 3.e.4. Korean Plans

This summary is based on a presentation given by G. S. Lee in September 2006 titled “Overview of Korean National Fusion Program, Current Status and Future Plans.”

The main topics covered in the presentation are:

- Energy situation in Korea (dependence on imported energy, CO<sub>2</sub> emissions, etc.)
- National Fusion Research Center organization
- KSTAR construction and operation
- ITER participation
- KO fusion energy development
- Process for establishing a Korean fusion energy strategy

A law-making process has begun to establish a long-term fusion energy strategy and to assure national energy security. The Fusion Energy Development Promotion Act provides for mid-term and long-term planning and resource allocation, for the establishment of a central institute, and for the support of ITER collaboration. Korea appears to be in the early stages of formulating its domestic long-term plan for fusion energy development.

#### Overall Strategy and Timescale

A Korean commercial fusion reactor supplying electricity to the grid is envisioned to begin operating in the 2040s. Its design will be completed when Demo demonstrates electricity production around 2035. Korea should “play a leading role” in the design of Demo.

#### Demo Characteristics

Demo will be designed to achieve 0.5 to 1 GWe continuous operation, with high beta normal (3.5-5.5).

#### Major Program Elements Leading to Demo

The four major elements are KSTAR, ITER, IFMIF, and fusion technology R&D.

KSTAR is being constructed for steady-state advanced tokamak (AT) research. First plasma is expected in June 2008. Following the initial operations phase, the three research phases will focus on steady-state operation, then high-performance AT-mode (beta normal ~5), and finally steady-state, high performance AT-mode.

## Draft FESAC sub-panel report – Do not circulate

Design and construction of KSTAR and components for ITER is providing valuable experience with large superconducting tokamak technologies. Operation of KSTAR will provide a test bed for contributing to ITER operations and for fusion technology development. The final research phase (steady state, high beta) will provide data for the design of Demo. Further experience with plasma operation and control and with reactor technologies will be obtained by participating in ITER operations. A fusion reactor technology R&D program will be developed to contribute to ITER and Demo. One part of that program will be building and evaluating test blanket modules in ITER. Participation in IFMIF for materials testing is anticipated.

### 3.e.5. Chinese Plans

This summary is based entirely on presentations by Jiangang Li, director of the ASIPP and Jikang Xie, deputy director of EAST tokamak.

Fusion energy is particularly appealing in China because of the rapid economic growth. The estimates are that the population will reach 1.6 billion by 2050, with energy per person approaching the levels currently experienced in Japan and Europe. Problems with alternate energy sources, especially pollution from coal, are particularly acute already.

Li articulates a three step program:

1. (2006-2010) Speed up the domestic MFE program
  - a) Establish good tokamak(EAST, HL-2M) research facilities
  - b) Starting R&D and construction of ITER –CN packages
  - c) The basic plasma science and education;
  - d) Start Demo-like reactor design and material program
  - e) Start key technologies for ITER
2. (2011-2020) Establish solid domestic MFE base
  - a) Advanced scientific program of tokamak research
  - b) Join ITER construction and H-operation
  - c) Training young scientists and engineers
  - d) Master the full technology for ITER-type machine.
  - e) Some key R&D technologies for Demo
3. (2021-2040) Fast Track for Demo construction by international cooperation or independent development
  - a) Demo design (physical simulation, engineering design)
  - b) Full R&D for Demo
  - c) Demo construction

Three major new facilities are contemplated in the plan.

FDS-I A fusion-fission hybrid whose goals would be to transmute radioactive wastes and produce fissile fuel. It is intended to be an early application of fusion. The machine would have a major radius of 4 m and produce 150 MW of fusion power, with  $Q \sim 3$ .

## Draft FESAC sub-panel report – Do not circulate

FDS-ST A Spherical tokamak based reactor which would serve the role of a CTF in the Chinese program. It would test technologies for tritium breeding, H<sub>2</sub> production and transmutation of radioactive wastes. The machine is envisioned to have a major radius of 1.4 m and produce 150 MW of fusion power at  $Q \sim 5$ .

FDS-II A fusion power test reactor, with a mission similar to that of Demo in the US or EU programs. Its goals include electricity generation at high thermal efficiency and power density. The machine would have a major radius of 6 m and produce 2500 MW of fusion power with a  $Q \sim 30$ .

Fusion-fission hybrids are apparently of interest to help provide fuel for fission plants which would otherwise limit total nuclear power to 10-15% of that required for the Chinese economy. Otherwise, the plan laid out, is similar in outline and schedule to that of the US and EU.

International cooperation is an important element of the plan (especially in its early stages).

### **3.e.6 Alternate Approaches For Fusion Development**

As noted above, this report focuses on “main-line” program elements supporting an ITER-Demo path. In this context, alternate concepts help validate fusion science, provide risk mitigation and represent possible improvements for following generations of fusion plants. The panel also heard from several community members who advocated fission-fusion hybrids as an alternate approach or interim step with respect to pure fusion systems. The panel felt that this class of devices were outside the scope of our charge. This issue was taken up several years ago by the FESAC panel on non-electric fusion applications, but not dealt with in any depth because the demand for fission power at the time was perceived to be small [1.10]. It may be that, due to concerns over global warming, the situation has changed and this option for fusion may deserve further attention.

## Chapter 4 Analysis of Gaps

### 4.a. Approach

As the set of broad questions was developed in response to the first part of the charge, considerable detail was amassed concerning the scientific and technical issues which will need to be addressed and the extrapolation required from the current state of knowledge. These finer scale issues were considered in light of existing and planned programs and a fine-granularity set of gaps was compiled. This list represents gaps in our knowledge that are likely to remain, with some reasonable probability, even after completion of the research program which is currently underway or in the pipeline. Of course it is not possible to predict with certainty, the results of scientific research, so this assessment represents only the best guesses and judgments of the panel.

For each fine-scale gap, we propose one or more measures which could be undertaken to fill the gap. These “mission elements” are research activities of various types, which would provide the technical information required, build confidence in our ability to analyze the complex physical systems involved and point toward solutions supporting practical application of fusion energy. In the following chapter, mission elements are combined into major initiatives, facilities or programs each of which, typically, would fill a number of the fine-scale gaps described here.

### 4.b. Compilation of fine-scale gaps and mission elements

For each issue, identified in chapter 2, the fine-scale gaps are listed and described. In each case the bulleted lists following the description of the gap are the proposed mission elements.

#### 4.b.1. Measurement

**a. Gap:** Sufficient measurement capability to validate predictive fusion science and to provide a reliable data stream for all necessary plasma control.

**Mission elements:**

- Develop and employ diagnostics for low-neutron facilities
- Upgrade the diagnostic set for ITER

**b. Gap:** Measurement compatibility with the nuclear environment of Demo. Issues to resolve include sensor survivability and new techniques that are consistent with the

## Draft FESAC sub-panel report – Do not circulate

auxiliary systems likely to be available. New measurements for analyzing the plasma-boundary interface and accounting for tritium will be required.

### **Mission elements:**

- Test nuclear-capable diagnostic techniques on non-nuclear facilities and ITER
- Test diagnostic components in a nuclear environment
- Improve predictive capability to reduce measurement requirements
- Deploy on future burning plasma experiments (e.g. CTF)

**c. Gap:** In-situ calibration of measurements in the near steady-state nuclear environment of Demo. Issues to resolve include gradual changes in optical and electrical diagnostic components, much less “off-line” access, and diagnostic compatibility with remote maintenance.

### **Mission elements:**

- Use long-pulse facilities to develop and test in-situ approaches and procedures

### **4.b.2. Integration Of High-Performance, Steady-State, Burning Plasmas**

The integration of high performance, steady-state burning plasmas is comprised naturally of four elements;

1. High performance burning plasma core,
2. Edge and scrape-off plasmas, and
3. Sustainment of magnetic configuration and plasma.
4. Optimization of the plasma configuration

#### High Performance Burning Plasma Core

##### Fusion Gain Extrapolation–

Results from experiments over the past 50 years of fusion research are summarized in the Lawson Diagram [Fig 2.b.2] and categorized according to magnetic configuration and plasma duration. Plasma temperatures in the range required for Demo ( $T(0) \sim 20$  keV) have been obtained routinely by several tokamaks. While not shown explicitly on this figure, plasma densities covering the range ( $10^{20}$ - $10^{21}$  m<sup>-3</sup>) have also been obtained in several experiments. The primary challenge has been to obtain the required temperature, density and confinement simultaneously in an integrated manner. A measure for the integration of confinement, temperature and density is the fusion gain ( $Q = P_{\text{fusion}}/P_{\text{ext-heat}}$ ), or the quantity  $n\tau_E T$  in a non-burning plasma. For short duration plasmas ( $\leq \tau_E$ ), plasma  $Q \sim 0.6$  was achieved in JET DT and “equivalent  $Q_{\text{DT}}$ ” of 0.7 was achieved in JT-60U DD experiments. For modest duration ( $\sim 5 \tau_E$ ) plasmas,  $Q \approx 0.2$  was achieved in TFTR and JET DT plasmas and “equivalent  $Q_{\text{DT}}$ ”  $\approx 0.2$  in JT-60U DD. For longer duration plasmas, the achieved equivalent  $Q$  (or  $n\tau_E T$ ) decreases significantly (see figure 4.b.2.1).

ITER will extend this range considerably with successful baseline operation at  $Q = 10$  for 500s. If the upgrades for modest AT ( $\beta_N \approx 3$ ,  $f_{\text{bs}} \approx 50\%$ ) operation are implemented,



ITER is expected to achieve  $Q = 5$  for 3,000 s.

**Gap in Fusion Gain** after ITER – factor of 5 to 10 for steady-state AT operation.

Plasma Confinement Extrapolation – Progress on achieving transport can be assessed by comparing the normalized confinement  $\beta_n B\tau_E$ , attained versus  $B\tau_E$  predicted based on empirical scaling. Results from the largest tokamak experiments today are within a factor of 3 of the  $B\tau_E$  required for a Demo plasma, and ITER will span a range in  $B\tau_E$  beyond the requirements for a Demo. Therefore ITER should provide the capability to test the predictive capabilities of physics based and empirically based models for H-mode based confinement and modest AT modes.

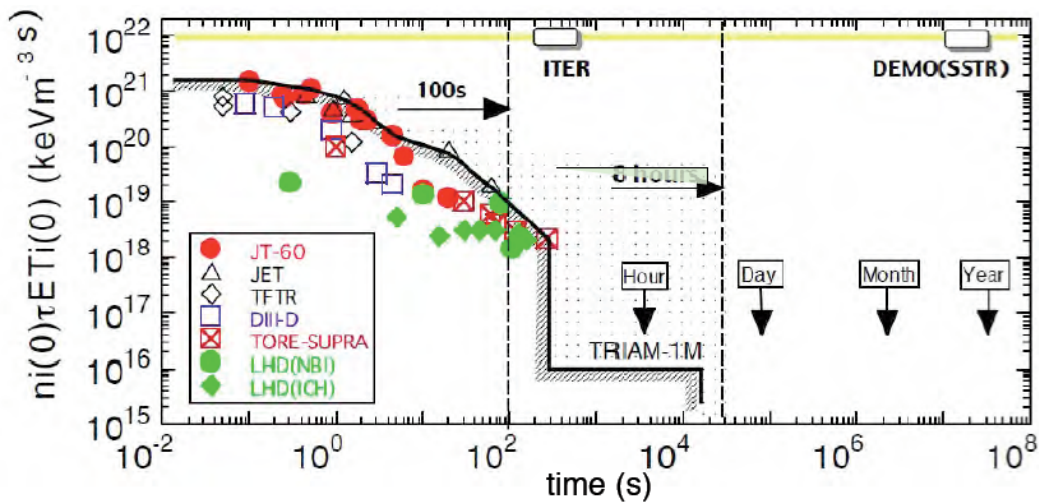

Fig. 4.b.2.1 Plasma performance vs pulse length (Kikuchi FT 2-5, 21<sup>st</sup> IAEA Fusion Energy Conference, Chengdu, China, 2006)

**Gap in Plasma Confinement** after ITER, JT-60SA, KSTAR etc –With a factor  $\sim 2$  in  $B\tau_E$  needed for a minimal Demo and a factor  $\sim 3$  for a Demo with AT modes at high  $\beta_N$  and  $f_{bs}$ . Need to clarify the minimum Demo requirements.

Fusion Power Density Extrapolation – In addition to high fusion gain, the burning plasma core must produce a significant fusion power density to achieve economic attractiveness. The conceptual studies of fusion power plants [4.b.2.1-3] indicate the need for a fusion power density of 2-5  $\text{MWm}^{-3}$  in the fusion plasma core to produce a neutron wall loading of 1-4  $\text{MWm}^{-2}$  on the first wall of the typical fusion power plant. Analyses of power plant plasmas with typical profiles and impurity content indicate the need for volume averaged plasma pressures,  $\langle p \rangle$ , of  $\sim 10$  atm. The ultimate figure of merit is the maximum  $\langle p \rangle$  that can be produced within the limits on the maximum magnetic field at the magnet coil  $\beta_{\text{fusion}} = \langle p \rangle / B_{\text{coil}}^2$ .

A summary of plasma pressures attained versus the magnetic field at the magnet conductor is shown in Fig 4.b.2.2 for various experimental devices compared to that expected from ITER and that required for a Demo plasma. Plasma pressures  $\sim 1$  atm

have been achieved for modest durations of several  $\tau_E$ , a maximum plasma pressure of 1.6 atm has been achieved in Alcator C-Mod for  $10 \tau_E$ . ITER is projected to produce plasma pressures of  $\sim 3$  atm ( $0.5 \text{ MWm}^{-3}$ ) within a factor of 3 in pressure and an order of magnitude in fusion power density and neutron wall loading of Demo.

**Gap in fusion power density after ITER – factor of  $\sim 10$**

Consequences of Plasma Instability and Magnetic Asymmetries - When the operational stability limits are violated large scale instabilities such as disruptions can occur with a range of consequences. Disruptions produce significant heat loads and electromagnetic loads on internal components. While existing devices have developed designs and operational techniques to mitigate the effects of disruptions, the driving forces and consequences will increase for ITER and Demo.

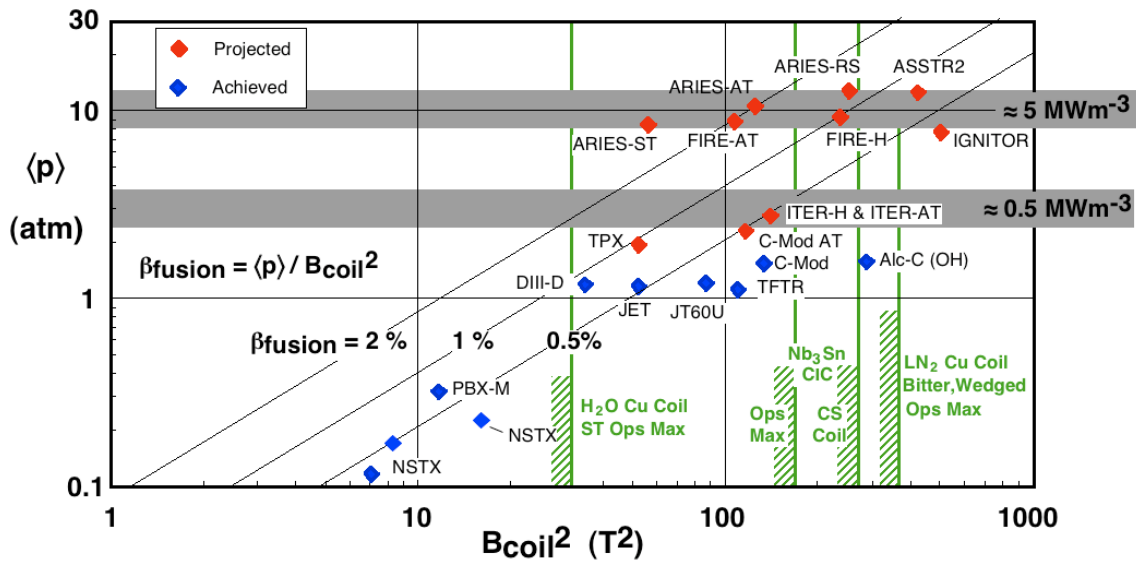

Fig. 4.b.2.2 Plasma pressure vs magnetic field at the coil.

**Gap in response to Disruptions after ITER** -The thermal plasma energy per unit first wall area ( $W_{th}/A_{wall}$ ) increases by 4.5 in going from JET to ITER, and a factor of 2.5 in going from ITER to an ARIES-like Demo. The poloidal field energy available to drive electromagnetic loads increases by  $\sim 18$  from JET to ITER with Demo being slightly less than ITER. Assuming the same materials and geometry, deflections and stresses in mechanical components due to currents induced by disruptions increase by a factor of  $\sim 2.5$  from JET to ITER with Demo  $\sim$  the same as ITER. The big step in disruption loads is from JET to ITER and the step to Demo is much more modest. The Demo first wall/divertor must be designed to remove higher power densities during nominal operation and to breed tritium. Detailed designs are needed to evaluate the impact.

The loss of a small fraction of the energetic alpha population due to instabilities or magnetic field asymmetries can produce severe localized heat loads and the possibility of He blisters. This has been observed in present experiments and techniques are being

developed to understand the source and mitigate the effects. A new issue is the magnetic asymmetries introduced by the ferromagnetic materials being proposed for the first wall and blankets. This issue will be addressed by JT-60SA and by test blanket modules in ITER. Metric: allowed  $P_\alpha$  loss (MW,  $\text{MWm}^{-2}$ , % of  $P_\alpha$ )

### Edge and Scrape-off Plasmas

The edge and scrape-off plasma provides the interface between the high temperature of the fusion plasma core and material walls of the vacuum chamber while exhausting the plasma energy and particles (especially alpha ash) at high power densities under steady-state conditions. The parameters of interest in understanding the edge plasma include:  $T$ ,  $n_e$ ,  $v_{//}$ ,  $Z_{\text{eff}}$ ,  $q_{//}$ ,  $P_{\text{loss}}/A_{\text{div}}$  ( $\text{MWm}^{-2}$ ).

Extrapolation required: EAST, KSTAR, and JT-60 will extend the study of edge and scrape-off plasmas beyond existing devices modestly in power density but will extend durations to several hundred seconds in non-burning plasmas. Since ITER's physical size is  $\sim$  Demo, it will provide significant capability to test various plasma edge and scrape-off models. After ITER, the extrapolation to Demo will be largest in particle fluence (several orders of magnitude) and modest ( $\sim 4$ ) in thermal power density on internal components that must be distributed over the first wall and divertor.

**Gap in Edge and Scrape-off Plasmas after ITER** – factor of 4 increase of exhaust power density,  $\sim 10^3$  increase in particle fluence and thermal energy per year and duty cycle for maintenance of low tritium retention conditions.

### Sustainment of the Magnetic Configuration and Burning Plasma.

Studies of magnetic fusion power plants indicate the need to operate with high availability over periods of  $\sim 1$  year. Steady-state operation is also highly desirable with an approximately factor of two benefit in estimated cost of electricity for steady-state operation relative to pulsed operation as in an inductively driven tokamak. The goal in this area is to have the capability of continuous operation for periods of  $\approx 1$  year.

### Magnetic Configuration Sustainment –

The major issues are the cost required to construct and operate a reactor-relevant current drive system, and the robustness of high gain burning plasmas to provide a large fraction of the plasma current in the presence of the strong coupling between alpha heating defined plasma pressure profiles, MHD stability and plasma transport.

Extrapolation for tokamaks – Existing tokamak experiments have sustained plasma durations of several minutes using inductive drive, and durations over five hours using RF drive. The advanced tokamak (AT) mode of operation, [4.b.2.4, 4.b.2.5], provides high  $\beta_N$  and a high self-driven bootstrap current, required for continuous high power density operation in a tokamak Demo. This mode of operation and has been adopted for the most advanced JA, US and EU power plant designs, and is being studied actively on existing tokamaks. The key parameters are given in Table 1.

Table 1a Advanced Tokamak Parameters

Advanced Tokamaks	$\beta_N$	$1-f_{bs}$ (%)	$q_{min}/q_{edge}$	$Ba_{min}$ (T-m)	Duration (s, $\tau_{CR}$ )
Advanced Tokamak Demo	4-5.4	20-30	2.4/3.8	~8	continuous
JT-60U Achieved	2.5	57	1/3	1.37	23, 12
DIII-D Achieved	4	40	1.6/3.9	1.0	2, 1
DIII-D Goal	5	20	1.5/4.5	1.3	2, 1
C-Mod Goal	3	30	2.4/5	0.8	5, 5
KSTAR Goal	5	10	3.5/7	1.7	300, 60
JT-60SA Goal	3.5 –5.5	30	1.5/5	3.1	100, 5
ITER Scenario 4 Goal	3	50	2.2/5.3	9.2	3000, 7

$\tau_{CR}$  is the plasma current profile redistribution time.

Experiments have achieved values of  $\beta_N$  or  $f_{bs}$  in a non-burning AT plasmas approaching those required for an advanced Demo. However, the duration on most present experiments is too short for the current and pressure profiles to evolve to equilibrium. Experiments planned for DIII-D, C-Mod, KSTAR, JT-60SA will extend these regimes to near steady-state conditions and ITER will extend these regimes to Demo scale ( $Ba$ ) and will begin tests with burning plasmas at  $Q \sim 5$  and moderate fusion power densities.

**Gap in Magnetic Configuration Sustainment (tokamak)** after ITER, JT-60SA, KSTAR, EAST, C-Mod, DIII-D – the gap will be in the integration of a high bootstrap fraction AT with a high-gain burning plasma. The difficulty of this integration increases as the external heating power and current drive power decrease. Using the product of external-heating fraction and externally driven current fraction -  $f_{ext-heat} \times f_{ext-CD}$ , as a measure of the control available during integration, the gap is a factor of  $\approx 20$  from ITER to an AT Demo.

**Magnetic Configuration Sustainment (Stellarator) –**

The issues for the stellarator are: closure of flux surfaces, energetic particle confinement in non-symmetric geometry, uncertain MHD limits, power and particle removal in 3-D geometry and the complexity and cost of the three dimensional structure.

Table 1b Advanced Stellarator Parameters

Advanced Stellarators	$\beta$	$i(a)/2\pi$	$f_{iota-bs}$ %	$R/\langle a \rangle$	$Ba$ (T-m)	Duration (s, $\tau_{CR}$ )
Advanced Stellarator Demo	5	~0.66	25	4.4	9.7	continuous
LHD Achieved	5	~1	~0	6-8	1.8	3240, ~1
HSX Achieved		1	~0	8	0.12	0.05, ~0.01
W7-AS Achieved	3.5	0.3 – 0.7	~10	11	0.375	2, ~0.1
NCSX Planned	>4	0.65	25	4.4	0.64	~2, ~0.3
W7-X Planned	5	5/6-5/4	~0	11	1.6	1800, ~1

Extrapolation for Stellarators - The largest stellarator in the world is the superconducting

## Draft FESAC sub-panel report – Do not circulate

LHD in Japan, which has demonstrated high  $\beta$  without any disruptions, and sustained operation without any external current drive. Stellarators can operate at much higher densities than similar tokamaks, stabilizing fast-ion driven instabilities and reducing the edge temperature to ease divertor design. HSX, a small quasi-helically symmetric stellarator is now in operation and a medium-size quasi-axisymmetric compact stellarator, NCSX, is under construction with experimental operations planned for 2012. The larger W-7X stellarator in Germany is expected to begin operation in 2014. These facilities will test the effectiveness of quasi-symmetry including fast particle confinement, plasma transport,  $\beta$  limits, MHD stability, particle and energy exhaust including ELM and disruption behavior.

**Gap in Magnetic Configuration Sustainment (Stellarator)** – W-7X will test the properties of non-burning plasmas with moderate parameters in an optimized isodynamic configuration for long pulses. LHD and W-7X are developing and demonstrating long-pulse power handling in 3D configurations. These large aspect ratio configurations are not favored for a Demo within the US community, due to their large size for a given fusion power. NCSX will test the properties of quasi-axisymmetric configurations, which are predicted to have transport properties similar to tokamaks and stability properties of stellarators at moderate plasma parameters. Large gaps will exist in extrapolation to a Demo, which may require a QAS stellarator performance extension experiment. Since the confinement properties of quasi-axisymmetric configurations are similar to tokamaks, the burning plasma physics should be informed by ITER through the predictive plasma modeling initiative.

**Plasma Sustainment** – The burning plasma fuel mix must be sustained by continual refueling of the plasma core in the presence of alpha ash and impurities generated by plasma wall interactions. ITER will provide a major test for the tokamak configuration and demonstration of particle control techniques since it is the roughly the same line density and temperature as a Demo plasma.

**Gap in Plasma Sustainment** – ITER will make a major contribution to filling this gap. Remaining issues will include alpha ash and impurity transport for AT plasma profiles and impurity generation at Demo exhaust power densities.

**Plasma Facing Component Sustainment** – The plasma facing components must have erosion lifetimes compatible with continuous operation at high power density in an intense neutron environment for up to one year. The erosion lifetime depends on plasma temperature near the plasma-material interface, on re-deposition of eroded materials and the properties of materials undergoing intense neutron irradiation. In addition, the retention of tritium in the PFC components must be much lower ( $< \sim 0.025\%$ ) than present experiments to allow continuous operation for one year. (See also section XXX)

**Gap in Plasma Facing Component Sustainment** – A large gap will exist in this area particularly for the effects of neutron irradiation on PFC materials properties that modify erosion/redeposition and tritium retention.

### Gap in Integration of Strongly Self-heated Plasmas

All previous experiments have been carried out with non-burning plasmas or at best a limited number of weakly burning plasmas. While some aspects of self-heating plasmas can be simulated; the integration of a plasma with strong self-heating by energetic alpha particles and alpha ash residue coupled with advanced modes of operation can only be resolved with confidence by actual experimentation. ITER will make major contributions in this area, but is limited in the power density and plasma durations that can be produced due to nuclear heating of the superconducting coils. Quantify gap to minimal Demo to advanced Demo.

### Mission Elements

- Improve simulation capabilities by improvements in theory and codes combined with experimental validation on a wide range of devices.
- Simulate integration of high-performance steady-state burning plasmas with non-nuclear facilities
- Test performance of intrinsically steady-state devices (stellarators) and assess potential for extrapolation to reactor regime
- Enhance AT capabilities in ITER, mainly by addition of appropriate actuators (heating and current drive) and diagnostics
- Build a new DT facility

### References

- [4.b.2.1] The ARIES Reports are at <http://aries.ucsd.edu/ARIES/DOCS/bib.shtml>
- [4.b.2.2] The EU PPCS Report is at [http://www.efda.org/downloads\\_divers/ppcs.pdf](http://www.efda.org/downloads_divers/ppcs.pdf)
- [4.b.2.3] M. Kikuchi, Y. Seki, and K. Nakagawa, "The Advanced SSTR," *Fus. Eng. and Design*, 48, Nos. 3,4 (Sep. 2000) 265.
- [4.b.2.4] C. Kessel, et al., *PRL*, 72, 1212, 1994.
- [4.b.2.5] T. Ozeki et al, *Proceedings of 14<sup>th</sup> International Conference on Plasma Physics and Controlled Nuclear Fusion Research 1992 Wurzburg, Germany, V.2* p 187.

### 4.b.3. Predictive modeling

Predictive modeling requires on large computer codes to address the complexity of actual experimental facilities. These codes will be used to extrapolate DEMO plasma operation from the physics database provided by the large experimental facilities within the world fusion program together with the burning plasma data which will be obtained from ITER operations. The entire predictive modeling effort will require an extensive program of code verification and model validation if it is to serve as a reliable basis for extrapolation to DEMO.

**Gap: Verification.** Code verification is the process by which the fidelity of a numerical algorithm with respect to underlying mathematical model is established and the errors in its solution are quantified. It is an exercise in mathematics and computer science. As currently practiced within the US magnetic fusion community, this exercise is left to the code development groups themselves. Other programs (e.g., the Advanced Scientific

## Draft FESAC sub-panel report – Do not circulate

Computing Initiative of Defense Programs) have recognized that the “best practice” is to have a neutral third party responsible for both code verification and validation [Oberkampf, 2002]. Funding limitations have prevented the formation of code verification and validation group(s). A minimum step toward assuring that the codes used for predictive modeling are an accurate implementation of the underlying physics model is to require that both the source code and a substantial data base of detailed code results are available to interested scientists.

**Gap: Validation.** Code validation is the process through which the scientific community comes to accept that a particular model reliably predicts real world behavior. It is an exercise in physics. Magnetic fusion experiments exhibit a rich variety of phenomena. A complete validation of our predictive modeling codes requires that these codes exhibit these same phenomena over the corresponding range of plasma parameters. Code validation is a tremendous undertaking, requiring active collaboration between the code development groups and the experimental and theoretical communities. In addition to continued support for code development and theory, it will require an investment in new experimental diagnostics to enable detailed comparisons between code results and experiment and substantial amounts of dedicated experimental time.

**Gap: Turbulence and Transport.** A problem specific to turbulence and transport is the large range of space and time scales which must be dealt with in a successful model of plasma microturbulence. Relevant length scales range from the electron gyroradius ( $\sim 10^{-5}$  m) to plasma equilibrium lengths scales (meters), while the time scales which must be bridged by gyrokinetic models range from electron transit times and characteristic periods of electron-scale turbulence ( $\sim 10^{-7}$  s) to the duration of ITER discharges ( $\sim 10^3$  s). Computational models must be developed which allow us to predict phenomena on macroscopic length and time scales while accurately modeling phenomena which occurs on microscopic length and time scales.

**Gap: Plasma Edge Turbulence.** The development of kinetic codes for studying edge plasma turbulence must be completed, and these codes must undergo verification and validation.

**Gap: MHD.** Verification and validation of fully nonlinear non-ideal MHD codes must be completed along with appropriate tools for designing feedback control systems required for tokamak operation beyond no-wall plasma pressure limits.

**Gap: RF wave propagation and absorption.** Improved models of RF wave propagation from the antenna through the plasma edge must be developed to enable accurate estimates of RF antenna loading. Improved models of RF-induced plasma rotation must be developed if RF systems are to fulfill their promise as actuators for systems aimed at controlling plasma profiles.

**Gap: Comprehensive, multiphysics modeling.** The development of a comprehensive model of tokamak plasmas is important because it will be the tool used to guide ITER operation and to extrapolate from ITER to DEMO. If such a model is to provide reliable

## Draft FESAC sub-panel report – Do not circulate

extrapolations it must be based on validated physics modules. It is only after the separate models of plasma phenomena described above mature and are validated in isolation, they can usefully be combined into such a comprehensive model.

### Mission Elements

- Improved diagnostics for existing and planned devices sufficient for validation of emerging models
- Enhancements to basic theory to provide the next generation of physical models
- Improvements in numerical models and algorithms
- Computing facilities capable of carrying out the production supercomputing required

#### 4.b.4. Control

The gaps in research in plasma control are primarily in the area of low power actuator development. In particular, a fusion reactor requires that the energy required for control be a small fraction of the total power from the reactor. This total power requirement should include any inherent inefficiencies in the control actuators themselves. To date, most kinetic control techniques (i.e. control of the plasma pressure, plasma pressure profile, plasma current, plasma current profile, and to a lesser degree the plasma rotation and rotation profile) have been based on the idea of controlling the input of energy to the system so as to affect the quantity of interest. In a burning plasma to maintain a low re-circulating power fraction, there will be very little energy input to the plasma relative to the plasma self heating. This implies that external heating, current or rotation drive will be limited, and that the pressure, current and rotation profiles be close to a self-consistent solution with only the alpha heating power, bootstrap current and plasma transport. Thus, a fortunate coincidence is required in order for a tokamak discharge to maintain a steady state in that transport must be consistent with an optimized MHD stable pressure and bootstrap driven current profile and the concomitant alpha heating profile. The need for this coincidence can only be obviated if the profiles of diffusivities or of the heating power itself can be controlled. The two generic methods by which this can be achieved are: 1) by control of the species mix and therefore the local fusion reaction rates, and 2) by control of the profile of the thermal diffusivity. 3) In addition, some current drive must be supplied to control the plasma current profile to maintain adequate margin with respect to MHD instabilities.

Problems of control diagnostic capability are being covered in the section 4.b.1. This gap analysis relies on the existence of a viable method for measuring the species profile and the plasma pressure and current profiles. It also assumes that measurements of plasma magnetic fields and fluxes (or equivalent replacements for boundary determination) are available so that plasma boundary control is not an issue for Demo.

##### **a. Gap:** Species mix profile control

The primary gap in this area is a viable deep fueling technology for reactor scale plasmas. This issue is discussed in the heating fueling section of this analysis. In



addition to this primary need, it would then be necessary to demonstrate that this technology could be used to control the species mix profile to the accuracy required for Demo. The exact level of the demonstration would depend on the state of knowledge and the predictive capability as well as the ability to localize and aim the fueling that was developed in parallel with this new fueling technology. The ability to control the species profile is a generic gap that would benefit all fusion reactor concepts.

### **Mission Elements**

- Develop and test fueling tools
- Simulate on non-burning plasmas
- Extend ITER capabilities

#### **b. Gap: Diffusivity control**

The primary method that is envisioned for controlling the profile of the thermal diffusivity in a plasma is indirectly through control of the toroidal rotation profile. Strong sheared toroidal rotation can facilitate a sheared radial electric field profile, that has been observed in current machines to suppress ion turbulence, leading to enhanced confinement in the shear region. The most popular method currently in use to induce toroidal rotation is neutral beam injection. Unfortunately, this method does not scale to a reactor plasma. Alternative methods with a more energetically favorable size scaling for inducing plasma rotation would be required in order to implement diffusivity control in a burning plasma. Such a tool would be powerful, in that it could be used to control the energy confinement time, and therefore the fusion heating power. If a mechanism were identified that had the potential for use in this application, control feasibility would need to be demonstrated. The value if this control technique is generic and would benefit all toroidal confinement devices that can support sheared toroidal rotation

### **Mission Elements**

- Develop theory and models for flow-drive techniques
- Test on non-nuclear experiments
- Extend ITER capabilities

#### **c. Gap: Current profile control**

There are several methods proposed that could be used for controlling the current profile in a burning plasma. However, the requirement of energy gain and economics for the reactor system places a severe constrain on the amount of power that can be used for this purpose. For this reason, it is envisioned for axisymmetric devices, such as the ST or AT which get the rotational transform from plasma current, most of this current will come from the bootstrap current. For control purposes, a small amount of external current drive capability is envisioned to help maintain a stationary operating condition and to correct for small deviations from the optimal current profile for MHD stability. However, the exact shape of the bootstrap current profile depends on the shape of the pressure gradient. The pressure profile is in turn determined by the turbulent transport of

## Draft FESAC sub-panel report – Do not circulate

energy, which is not yet understood or predictable. Thus, the exact external current drive requirement is not predictable and it must be demonstrated that a viable control solution exists for a burning plasma which gets the majority of its rotational transform from plasma current and the majority of its plasma current from bootstrap. The plasma current profile control gap is not generic, as the stellarator concept gets its rotational transform from external non-axisymmetric coils.

### **Mission Elements**

- Develop current-drive techniques
- Test on non-nuclear experiments
- Extend ITER capabilities

### **4.b.5. Off-normal events**

**a. Gap:** High-performance operating regimes in tokamaks consistent with Demo requirements that are free of disruptions and other off-normal plasma events (e.g., ELMS), or reliable methods of detection and response that allow avoidance or mitigation of plasma events that could otherwise force a reactor to shut down for major repairs.

### **Mission Elements**

- Discover high-beta, high-bootstrap-fraction operating regimes on existing or planned tokamaks that are simultaneously free of disruptions, ELMS, and run-away electron events.
  - Improve understanding of operational and disruptive limits in high-performance regimes using theory and modeling validated by experiments.
  - Improve, develop, and test real-time diagnostics, analysis, and actuators that are capable of maintaining high-performance regimes free of off-normal events, and that will be able to function in the fusion environment of a Demo.
- Improve understanding of off-normal event development in high performance regimes on existing and planned tokamaks, and develop and validate reliable techniques for controlling or mitigating these events.
  - Improve theory and modeling of the growth and development of disruptions in high-performance regimes, including possible precursors that could be detected reliably in the fusion environment of Demo.
  - Improve or invent and validate real-time diagnostic and analysis techniques for predicting the onset of off-normal events, which will be able to function in the fusion environment of Demo.

## Draft FESAC sub-panel report – Do not circulate

- Improve or invent and test actuators needed to avoid off-normal events or mitigate their impact, using approaches that can be extrapolated for use in the fusion environment of Demo.
- Test the effectiveness of these newly developed avoidance and mitigation techniques in the burning regime using either an ITER enhanced to operate in high-performance regimes (AT), or using a new DT-burning integrated AT-physics demonstration device. Based on the test results evaluate the potential effectiveness of these avoidance and mitigation techniques in the more demanding fusion environment of Demo including the requirements for reduced wall armor for tritium breeding, high reliability, and reasonable cost.

**b. Gap:** Sufficient understanding of other confinement configurations with the ability to run without off-normal plasma events.

### **Mission elements**

- Extend the understanding of confinement and other properties of configurations that avoid off-normal plasma events using new performance extension devices. Then assess the potential of these configurations to provide the high-performance regimes and other characteristics required by Demo.

### **4.b.6. Plasma Modification By Auxiliary Systems**

**a. Gap:** Plasma Heating: Even in a high gain plasma, some level of auxiliary plasma heating is required for start-up, sustainment and instability control. This needs to be achieved precisely and efficiently. New systems/technologies have to be developed or expanded to meet the requirements of Demo

### **Mission Elements**

- Higher frequency, high unit power, and higher efficiency microwave sources (gyrotrons) need to be developed for Electron Cyclotron Heating.
- EC Launching mirrors will have to be developed that minimize erosion and to handle the higher neutron and heat fluxes of Demo.
- The decreased ICRF coupling with large antenna-plasma gaps could be addressed by an improved understanding of RF wave coupling to plasmas.
  - Or develop alternate antenna configurations, which have higher antenna-plasma gap tolerance.
- To penetrate the higher density plasmas envisioned for Demo, higher energy neutral beam injectors will need to be developed.

**b. Gap:** Plasma Current Drive: For steady-state operation the plasma current will have to be produced in a non-pulsed (non-inductive) manor, and owing to the low

## Draft FESAC sub-panel report – Do not circulate

current drive efficiencies of most non-inductive means, a high fraction of internally generated current (bootstrap current) is desirable. However, high performance plasmas, with high bootstrap currents are very susceptible to instabilities, where tearing modes create zones of zero or low bootstrap current.

### **Mission Elements**

- Higher frequency, high unit power, and higher efficiency microwave sources (gyrotrons) need to be developed for Electron Cyclotron Heating.
- EC Launching mirrors will have to be developed to minimize erosion and to handle the higher neutron and heat fluxes of Demo.
- To localize RF current drive there is a need to improve the understanding of RF wave coupling to plasmas
  - Or develop alternate antenna configurations, which have improved current drive directivity.
- Alternate launcher concepts for Lower Hybrid Current Drive (LHCD), need to be validated for effectiveness and functionality prior to use on Demo.

**c. Gap:** Fueling and Exhaust Control: Operation of Demo steady-state for weeks or months at a time, at high fusion power production, requires that the fuel concentration in the core of the plasma be adjustable and renewable.

### **Mission elements**

- Increase the understanding of the processes of D-T fuel consumption or loss through transport, or dilution by He ash accumulation.
- Increase the ability to measure the isotopic mix in the core, enabling the optimization of the fusion performance.
- Improve the ability to process large quantities of Tritium on a continuous basis.
- Develop new methods of core fueling.

**d. Gap:** Edge Control: The need to manipulate the very surface of the plasma, such as is required to inhibit the presence of Edge Localized Modes (ELM), or Resistive Wall Modes (RWM), may require coils to be placed relatively close to the plasma, with a wide bandwidth capability.

### **Mission elements**

- Water-cooled coils that can survive the heat and neutron fluence near the plasma boundary will need to be developed.
- Robust methods of measuring the surface conditions will need to be developed and tested.
- Improve understanding of how the lowering of the plasma edge density and pressure leads to the plasma becoming stable to peeling-ballooning modes, which drives ELMs.

## Draft FESAC sub-panel report – Do not circulate

- Improved understanding of the use of Resonant Magnetic Perturbations (RMP) from a set of correction coils which can produce a toroidal mode  $n = 3$ , for the control of edge density.

**e. Gap:** Rotation Control: To optimize plasma confinement in high beta plasmas, edge rotation improves performance by producing radial velocity shear, which acts to stabilize micro-turbulence and thereby improving plasma confinement.

### **Mission elements**

- Alternate means will need to be implemented to enhance plasma rotation, if the rotation is below the threshold where the radial velocity shear can be effective.
- Dedicated tangentially oriented neutral beams injection can provide the momentum need for adequate plasma rotation.
- Plasma poloidal flows can be driven by ICRF waves (primarily Ion Bernstein Waves, IBW). Improved understanding of this process needs to be developed.

### **4.b.7. Magnets**

- a. **Gap:** Increased understanding of superconducting magnet systems to allow improved performance, reduced design margins, lowered costs.

#### **Mission element**

- Improve and validate, on test stands, models of superconducting magnets: Fundamental understanding must be increased for coupled processes like mechanical strain, critical field and current and crack growth to allow design of magnets with improved performance and lower cost.

- b. **Gap:** Reduction of frequency and consequences of magnet quenches (includes improved diagnostics and modeling)

#### **Mission element**

- Improve modeling and diagnostics for detection of quenches in superconducting magnets: To reduce the frequency and consequences for magnet quenches, particularly in high-temperature superconductors, a research program must test new methods for improving the sensitivity and reliability of real-time quench detection.

- c. **Gap:** Advanced fabrication techniques for high temperature superconductors to improve performance and to reduce cost (power) and complexity of the cryogenic cooling systems.

#### **Mission elements**

- Test designs for high-temperature superconducting magnets suitable for fusion: The understanding of fabrication and performance of high-

## Draft FESAC sub-panel report – Do not circulate

temperature superconductors must be improved and tested in the laboratory.

- Deploy high-temperature superconducting magnets on new or upgraded confinement experiments: Successful laboratory tests of these magnets should be followed up by development of techniques for industrial fabrication and field tests on magnetic confinement experiments.
- d. **Gap:** Electrical and thermal Insulators capable of withstanding the nuclear environment

### **Mission elements**

- Improve computational models of the basic materials properties subject to intense fusion neutron bombardment.
  - Conduct research using neutron and other radiation sources to qualify insulator materials.
- e. **Gap:** Magnets consistent with overall system maintainability

### **Mission elements**

- Conduct research into design and fabrication of superconducting magnets with demountable joints: The prospect for building such magnets must be investigated by testing innovative approaches, for example the deposition of high-temperature superconducting material directly onto structural plates.
- Deploy superconducting magnets with demountable joints on new or upgraded experiments: Successful laboratory tests of such magnets can be followed by field testing on magnetic confinement experiments.

### **4.b.8. Plasma-Wall Interactions**

**Overall Gap:** Sufficient understanding of plasma-wall interactions to predict the environment for and behavior of plasma facing and other internal components for Demo conditions.

ITER will provide extensive information on the response of plasma facing walls to long pulse high power plasmas including tritium retention and transport in materials. Long pulse non-DT machines such as KSTAR, JT-60SC, and EAST will supplement the ITER data with even longer integrated plasma exposure time but without neutron irradiation effects. Successful completion of these experiments will still leave a significant gap that must be filled before Demo can be licensed as a nuclear facility. Because of the significant increase in availability (plasma operating time versus wall clock time) and the much greater tritium usage rate on Demo, it will be necessary to have a predictive model capable of accurately forecasting both the edge plasma conditions and the response of the plasma facing material to the fusion plasma. In order to achieve the required accuracy several interrelated aspects of plasma wall interactions must be accurately measured and

## Draft FESAC sub-panel report – Do not circulate

physical models constructed that can be used for extrapolation to Demo. These aspects include:

- a. **Gap:** Characterization of Scrape-Off-Layer (SOL) turbulence and transport including ions, neutrals and impurities in the edge plasma region.

While simulation models such as UEDGE can be used to match several features of the Scrape-Off Layer (SOL) plasma in fusion devices, these codes have many free parameters which are set to match the data but are not based on first principles. New phenomena have been added to the models, but the number of free parameters has also increased. Edge plasma properties for ITER are being calculated using a range of the free parameters found on existing machines. Since ITER and Demo are likely to be similar in size, information gained from ITER operation is likely to be applicable to Demo. A strong modeling effort to understand the physics of the SOL is needed to increase confidence in predictions for Demo.

- b. **Gap:** Understanding of non-plasma effects such as radiation transport in optically thick plasma or neutral effects in dense plasma.

One of the strategies for managing the power density in the divertor in Demo is to use a combination of high density operation and impurity injection in the divertor to radiate power to a larger area than energy conduction in the SOL would allow. Such an operating mode for the divertor creates a region where both the photon mean free path and the neutral particle mean free path are short compared to the size of the region. The usual fluid models of the SOL are not appropriate for such a region. Coupling of a model that works for optically thick dense plasma with the conventional SOL codes is needed for Demo.

- c. **Gap:** Strategies to mitigate impurity generation associated with RF sheath production.

Radio Frequency heating is preferred for Demo because the large ports needed for neutral particle heating would allow neutron flux and tritium to spread over a much larger volume. It is observed on many fusion devices that RF heating can generate hot spots on nearby plasma facing components. Those hot spots can be sources of impurities that can enter the core plasma and ruin confinement. The mechanisms responsible for such hot spots are not clearly understood. ITER will utilize RF heating and may provide important data for Demo if proper diagnostics are installed. Additional phenomena need to be added to plasma edge codes and calibrated against observations to allow prediction of Demo conditions.

- d. **Gap:** Quantitative understanding of processes which generate impurities  
Basic processes such as sputter erosion and evaporation are well understood through both experiment and modeling. In a fusion device several synergistic effects are present that greatly complicate the understanding of impurity

## Draft FESAC sub-panel report – Do not circulate

generation and how those impurities are transported to and from the core plasma. For example, fusion devices use mixed PFC materials and have very high particle flux. Laboratory simulation devices (e.g., PISCES) used to study impurity generation can achieve the particle flux but their plasmas are typically not true Maxwellian distributions at the temperature typical for a fusion device. Mixed materials are just beginning to be studied in laboratory devices. Measurements in fusion experiments are difficult because edge plasma conditions are spatially and temporally varying and the ability to remove test articles after exposure is limited. Plasma operating time is rarely dedicated to studying edge plasma physics and studies must be done in conjunction with other experiments that may vary parameters more than would be ideal for impurity generation studies. It is unlikely ITER will dedicate more time to impurity generation studies. Improved laboratory simulation and modeling is the most likely path to success.

- e. **Gap:** Characterization of processes that lead to tritium retention  
Experience from the two DT fusion devices has shown that tritium retention can be quite high (10-50%). Laboratory experiments and similarity experiments on DD devices have shown much lower values but those experiments have much large uncertainty due to different operating conditions. ITER will be the first device that has significant neutron fluence on PFCs. Neutron radiation damage occurs throughout the thickness of materials and creates sites where T can be retained. The synergistic effects of high plasma particle flux and neutron damage have never been studied. It will be very important to study specimens from ITER and measure T retention. However, ITER has no plans for installing easily removable wall samples.

### Mission Elements

- Improved theory and computer models for SOL
- Validation using ITER and non-nuclear experiments, including significant improvements in edge diagnostics and experimental time
- Modeling of ion transport and redeposition including dust generations and modification of PFC surfaces.
- Detailed studies of RF sheath formation and impurity generation using improved computer models and experimental tests.
- Study of sputtering, chemical erosion and evaporation in devices with mixed material PFCs
- Improved modeling of first-wall substructure and its influence on tritium retention
- Tests on new or existing very-long pulse devices
- Tests on devices with high neutron fluence



### 4.b.9. Plasma Facing Components

**Overall Gap for Solid PFCs:** Understanding of the properties of low activation solid materials, joining technologies and cooling strategies sufficient to design robust first-wall and divertor components in a high heat flux, steady-state nuclear environment.

Since Demo will be a nuclear reactor, it will have to meet all the licensing requirements typically applied to fission reactors. All processes needed to manufacture components and structures will have to pass rigorous quality control and assurance inspections. Extensive testing of components will be required to show that failure modes are understood and accounted for in the design and that reliability has been demonstrated. Since Demo will be the first ever fusion reactor and first of a kind components will be utilized, the amount of supporting testing will be greater than for fission reactors that have extensive operating experience.

The few long pulse fusion devices all use water cooling for PFCs. ITER and other long pulse machines under construction also plan to use water cooled PFCs. However, most Demo concepts assume high temperature helium gas cooled PFCs and several major developments are needed. The starting point is new refractory metal alloys that have adequate thermal conductivity and resistance to neutron damage. Innovative helium gas cooled heat sink designs must be developed that can remove the heat flux predicted for Demo with sufficient thermomechanical margin. Reliable methods for joining the plasma facing material to the heat sink in the neutron environment of Demo must be discovered. Finally, the tritium retention characteristics of these components must be measured.

**Gap:** Identification and qualification of materials which can take the survive the heat loads and survive damage from neutron fluence:

Tungsten is the lowest activation refractory metal that has adequate thermal properties to be used as a PFC for Demo. Pure tungsten has a high ductile to brittle transition temperature (DBTT increases with neutron irradiation), and it is difficult to fabricate. There is one small research effort in Japan that has had success in improving ductility through nano-particle alloying with TiC. Similar techniques have been shown to improve the characteristics of Mo alloys. There is a need for a much larger effort to invent a new alloy since a suitable material is the basis for component development. Heat sinks may be constructed from materials other than tungsten but there will be higher activation and greater waste disposal issues.

**Gap:** Characterization of welds, brazes or other joining technique that can carry high heat fluxes in the presence of high neutron fluence:

Collaborations between the US and Russia have started research on braze materials that can be used to join W to W, or Mo, or Nb. The results are promising but the effort needs to be expanded to assure adequate development and testing for Demo. Conventional welding and machining techniques typically do not work with refractories because of their high melting points. Development of suitable processes will require extensive destructive testing to

## Draft FESAC sub-panel report – Do not circulate

understand the failure mechanisms. Fundamental studies of the fracture mechanics of the joints will be needed to develop reliable components. Some of the testing must be done on irradiated components to prepare for large scale testing on a Component Test Facility.

**Gap:** Strategies for heat removal with gas coolant at high temperatures while maintaining structural integrity, especial with respect to temperature excursions or other off-normal events:

Use of porous metals for high performance heat sinks is a rapidly developing field of research. Helium gas cooled porous metal heat sinks (non-refractory) have demonstrated heat removal capability nearly equal to water cooled heat sinks with modest pressure drop and reasonable mass flow rate. Techniques for manufacturing refractory porous metal structures exist and are being used to prepare gas cooled heat sinks for heat flux testing. These experiments are being done on a small scale and slowly because of funding limitations. The development of reliable water cooled heat sinks for ITER took about ten years with a large international collaboration and sufficient funding. The existing level of world-wide effort will not complete this task in 35 years.

**Gap:** Characterization of tritium effects including permeation, embrittlement and retention:

Tritium permeation rates increase strongly with increasing operating temperature. Since overall thermal efficiency increases with operating temperature, most Demo designs call for operation at around 1000 C. Strategies such as double walled pipes must be used to collect tritium permeating through PFC coolant feed pipes. Development of such systems is also needed for breeding blankets. Some materials being considered for heat sinks (e.g., Nb and V) have an affinity for hydrogen atoms. Absorption of H in such materials generally causes embrittlement. If such materials are used for PFC, a strategy for limiting absorption must be developed. Permeation barriers seem to work well in the absence of neutron irradiation, but development is needed for nuclear applications. The commercial reactor production of tritium program is conducting research on this topic but the results are classified.

### **Mission Elements**

- Modeling and validation on test stands
- Validation of designs on nuclear and non-nuclear confinement experiments
- Qualify materials with high-fluence neutron bombardment including fission and accelerator sources
- Conduct research on tritium effects on test stands
- Test components on nuclear test stands
- Qualify components with high-fluence fusion device (CTF)

## Draft FESAC sub-panel report – Do not circulate

**Overall Gap for Liquid PFCs:** Knowledge base for utilizing liquid surface first-walls, including plasma interactions and magnetic effects.

The high-risk high-reward alternative to solid PFCs in Demo is free surface liquid PFCs. Liquid surface PFCs are just beginning to be tested on fusion machines. Initial results are promising but the understanding of several phenomena must be improved before the results can be extrapolated to larger longer pulse machines. These include magnetohydrodynamic modeling of moving conducting liquids in spatially and temporally varying magnetic fields, control of the flowing liquid, and helium particle pumping.

Liquid surface PFCs eliminate all of the deleterious effects of neutron irradiation and particle erosion as limitations on the lifetime of the components. Liquid Lithium has the added benefit of strongly pumping hydrogen. Since the liquid is also the heat removal medium, heat removal capabilities can exceed those of solid heat sinks by at least a factor of five for reasonable liquid flow velocities. The difficulty of liquid surface PFCs is the interaction between moving conducting liquids and the fusion machine magnetic fields. The currents induced in the flowing liquid interact with the magnetic fields and generate forces that can severely distort the liquid surface (even to the point of injecting liquid drops into the plasma). Time varying magnetic fields in a fusion device can also cause such distortion of the liquid.

**Gap:** liquid compatibility with structures

All of the liquid metals being considered for fusion machines (Li, Sn, In, and Ga) react strongly with solid materials that could be used for pipes, nozzles and pumps. Research is needed to determine if coatings or alloys exist that are compatible with flowing liquids in fusion devices at the desired operating temperatures. Methods are needed to create openings in the liquid for vacuum pumping, plasma diagnostics, or RF heating.

**Gap:** techniques to control mass flow - effects of moving conductors in magnetic field

Magnetic levitation or stirring of molten metals is used extensively in preparation of special alloys or crystal growth. There is a large capability for modeling magnetic effects on liquid metals at low magnetic field and/or velocity. The extension of the models to high field and/or velocity has proved to be a very difficult problem because the thickness of the boundary layers becomes very small compared to the system size. Development of suitable magnetohydrodynamic models is in progress but being limited by available funding. Experiments to validate the models are being conducted in a few laboratories but the facilities have limited capability because of funding limits. Model development is required to design liquid PFCs for fusion devices. Model development is setting the pace of application on fusion machines.

**Gap:** assessment of evaporation and impurity generation into plasma

## Draft FESAC sub-panel report – Do not circulate

Experiments have determined that particle flux increases the evaporation rate of liquids near the melting point. The transport of evaporated liquid atoms to the plasma is uncertain because of issues discussed in the Plasma Wall Interaction section. Since the evaporated atoms are easily ionized near the liquid surface, evaporation lowers the sheath potential and can lead to thermal run-away because of the greater mobility of plasma electrons. This phenomenon has never been studied in a fusion device. The exact temperature limits on liquid are uncertain because of these uncertainties.

### **Gap:** strategies for helium pumping

While some liquid metals are known to aggressively pump hydrogen, all liquid metals have low solubility and high diffusivity for helium. Some calculations have shown that helium might form bubbles in the liquid at high particle flux. If the liquid is removed from the fusion device before the bubbles can float to the surface, helium could be pumped by a flowing liquid surface. There has been no experimental observation of this capability. In the absence of such a mechanism, conventional vacuum pumping techniques must be used for helium ash control. This implies the need to create openings in the flowing liquid surface for access to pumping ducts. Only sketches of such systems have ever been made.

### **Mission Elements**

- Research on liquid target plates and modules on non-nuclear confinement experiments
- Modeling and validation on test stands especially on MHD effects on free-surface liquids
- Develop strategies and designs for extending coverage to all high heat-flux areas
- Test components on nuclear test stands
- Qualify components with high-fluence fusion device (CTF)

### **4.b.10. Internal components**

Overall gap: tools and capability to design RF antennas and launchers, control coils, final optics and any other in-vessel diagnostic equipment to deliver at high reliability the desired functional performance during extended operation in a nuclear plasma environment.

ITER, together with long-pulse non-DT machines such as KSTAR, JT-60SC, and EAST, will provide the impetus to develop high-performance, active in-vessel components for heating, control and diagnostic components, and will also provide data and experience on the performance of these components in an environment of high fluxes of heat, particle, electromagnetic radiation, and neutrons for periods of the order of thousands of seconds.

## Draft FESAC sub-panel report – Do not circulate

Going beyond these experiments towards a D-T DEMO reactor requires extrapolation from these experimental components to designs that are fully-qualified for long service life (~years) in a nuclear power environment in which the fluxes are 3-5 times greater than those in ITER.

### Gaps:

- a. Validated techniques for predicting particle, heat, and neutron fluxes on passive components (e.g. sensors, mirrors, etc) in realistic geometry in both normal and off-normal operating conditions.
- b. Validation of techniques for computing heating performance and self-consistent heat and particle fluxes to high-power, energized components (RF antennas, microwave launchers, etc) which interact with and alter the edge plasma.
- c. Qualification of structural, shield and coating materials with which to construct internal components, and appropriate joining/bonding technologies. As for other plasma-facing and structural components, these materials will need to be fully tested to industry standards in materials testing facilities.

### Mission Elements

- Modeling and validation on test stands
- Deploy and test Demo-capable antennas, LHCD launchers in non-nuclear experiment
- Validate design approaches on CTF

### 4.b.11. Fuel cycle

Overall Gap: Understanding the elements of the complete fuel cycle particularly tritium breeding and retention in vessel components.

ITER will be the first opportunity to measure the capability of breeding blankets in an actual fusion environment. Many institutions have been planning for installation of Test Blanket Modules (TBM) on ITER for several years, however, TBM are not yet officially part of the ITER project. Design studies and laboratory experiments have shown that there are several interrelated effects that must be understood before reliable tritium breeding blankets can be developed for Demo.

**Gap:** strategies for high-efficiency breeding ( $TBR > 1$ ), choice of liquid or solid breeding material, basic thermal-hydraulic design

The nuclear cross-sections for tritium breeding are accurately known. Solid breeders have the issues of tritium transport within the breeder, thermal and neutron induced sintering (densification) of the breeder, and heat transfer in the blanket. Liquid breeders have the issues of corrosion, MHD pressure drop,

## Draft FESAC sub-panel report – Do not circulate

and tritium permeation. Flibe (Lithium and beryllium fluoride mixture) requires composition control because of the possibility of forming free fluorine or TF both of which are highly corrosive. Only laboratory experiments have been done on either type of breeder. Combined effects are poorly studied and understood. The ITER TBM is the first opportunity to study integrated effects and measure generation rates under realistic conditions. The size and neutron fluence limitations on ITER force the need for tests on larger components and at higher fluence between ITER and Demo.

**Gap:** materials for breeding modules capable of maintaining structural integrity at high temperature in presence of large neutron fluence

There is an extensive effort to develop ferritic steel alloys suitable for fusion blanket structures and substantial progress has been made in developing high-temperature capable alloys. Testing of the new alloys has shown that the properties are compatible with the fusion neutron environment. Studies of manufacturing processes needed for blanket modules is in progress. Vanadium alloy development has been set aside under constrained budgets because of poorly developed US infrastructure for manufacturing refractory alloys and limitation of V alloys to only Li self-cooled blanket concepts. Silicon carbide development is in an early stage and it is too early to tell if the material will be suitable for blanket structures. (See the materials section for more details.)

**Gap:** tritium permeation must be controlled in high temperature blankets

In solid breeder blankets the tritium is swept out of the blanket with helium gas which also cools the blanket. Alternative systems have two separate systems for tritium and heat removal. Demo studies all indicate the desire to operate at temperatures near 1000 C. Permeation of tritium through the coolant or tritium removal pipes can be quite large at such temperatures. One potential solution is to use double walled pipes with helium sweep gas between the pipes, but this is complicated. Another potential solution is to apply a permeation barrier inside the pipe. Permeation barriers apparently work well in the absence of neutron irradiation, but development is needed for nuclear applications. The commercial reactor production of tritium program is conducting research on this topic but the results are classified. For liquid breeder systems, the liquids being considered all have low solubility for tritium except for liquid Li. They all have the same permeation issues at elevated temperature. Tritium trapped in liquid Li has to be removed chemically (see below).

**Gap:** recovery and separation of tritium with high throughput

Demo requires tritium processing that exceeds the ITER requirements by a factor of 2-4. Experience in the chemical industry shows that such a scale-up in throughput takes 5-10 years. This should be able to be done between ITER and Demo. However, facilities to conduct testing with specific breeder systems do not exist. The only US fusion tritium system has a 0.5 g limit.

## Draft FESAC sub-panel report – Do not circulate

Removal of contaminants from the T containing gas stream is much easier for the blanket system than for the vessel pumping system. Chemical techniques for removing T from Li have been published. Scaling those processes to Demo size is as discussed above.

### **Gap:** Tritium retention in all components

Because of neutron damage to materials, it is impossible to prevent tritium retention in breeder materials. Through a combination of temperature control and design features including permeation barriers it is likely tritium inventory can be controlled. Testing of such techniques should first be done on the laboratory scale and then on a Component Test Facility.

### **Mission Elements**

- Modeling and validation on test stands
- Exploit fission reactor and other facilities to test breeder concepts
- Research on tests stands for exploring chemistry issues as well as physical extraction and separation
- Prepare for and participate in ITER TBM
- Validate models and qualify components with high-fluence fusion device (CTF)

### **4. b.12. Power extraction**

Power extraction is a fundamental challenge for an attractive fusion energy source. The scientific issues encountered in fusion power extraction are substantially different than other energy sources including fission. Examples of these unique attributes include:

- a. a very high surface heat flux and potentially high peaking factors,
- b. a complex volumetric heating source involving both plasma products (neutrons, particle, and radiation) as well as nuclear reaction in the power extraction components,
- c. strong impact of electromagnetic field (both static and dynamic) on heat transfer,
- d. large temperature and stress gradients which can derive a multitude of complex physical phenomena,
- e. compatibility with the fuel cycle (tritium production and extraction),
- f. complex geometry, and
- g. an evolving material properties (e.g., due to radiation effects).

In addition the power extraction components are inherently coupled to plasma performance (e.g., plasma-material interaction on the first wall and divertor), as well as the power conversion cycle and safety. The research in this area to date has been mainly limited to concept exploration and some single-effect experimentation. There is a fundamental need to develop the engineering science of power extraction

### **Mission Elements:**

- Simulation and bench-top experiments to understand single-effect phenomena (fluid dynamics, heat transfer, MHD effects, life-limiting phenomena, permeation, embroilment, tritium retention, corrosion, ...)
- Partially-integrated tests on non-nuclear facilities to uncover synergetic effects.
- Test-article and partially integrated test on fission reactors.
- Integrated test on high-fluence facility such as CTF.

### **4.b.13. Materials**

The overarching gap is lack of knowledge of the potential behavior of a host of functional and structural materials in the fusion energy environment, where the presence of intense gamma ray and high energy neutron fluxes along with high heat fluxes, tritium, high temperature coolants, and in many cases high mechanical stresses creates a uniquely hostile operating environment with no existing appropriate fusion-relevant test bed to develop and qualify suitable materials.

**Gap:** Predictive multiscale models of materials behavior in the fusion environment

### **Mission elements**

- Development of multiscale materials modeling initiative. The main goal of this initiative would be to transform the materials science basis that will enable discovery of new high performance materials with tailored properties for the harsh fusion environment. A major focus of this initiative should investigate improved methodologies to accurately and efficiently pass information between computational models at different length and time scales, including new computational algorithms to improve the current computationally expensive atomistic models that currently limit atomistic simulations to 100-1000 atoms (order  $N^6$  for quantum chemistry models and  $N^3$  for density functional theory using the low density approximation, where  $N$  is the number of electrons in the system)
- Exploration of new reduced-activation material formulations tailored for superior performance in the fusion environment (including low decay heat and low long-term induced radioactivity). This will involve utilization of commercial computational thermodynamics codes as well as atomic- and meso-scale models developed in the FSP-scale materials modeling initiative.
- Analysis of magnetic perturbations of the plasma from ferritic steels. A higher fidelity analysis is needed to quantify the effect of magnetic perturbations introduced by the ferromagnetic ferritic steel structure on the stability and control of the plasma under ignition and burn conditions. This could perhaps be included as a stand-alone subtask within an FSP-style materials modeling initiative.



## Draft FESAC sub-panel report – Do not circulate

**Gap:** Constitutive mechanical properties of structural and breeding blanket materials in the fusion environment

### **Mission elements**

- Effects of fusion-relevant irradiation on the mechanical properties of structural materials. The simultaneous presence of high neutron fluxes and transmutant He, H and other solutes in materials irradiated in the fusion reactor environment is expected to cause enhanced hardening and loss of ductility compared to fission reactor conditions, and degradation in fracture toughness is also anticipated. Coordinated high-fidelity models and experimental validation are needed to develop physically realistic constitutive equations for the mechanical behavior of structural materials under fusion irradiation conditions. The new models will need to consider both bulk hardening effects associated with the formation of nanoscale radiation defect clusters as well as segregation of minor solute elements to grain boundaries and other interfaces that can lead to localized premature fracture. Mechanical deformation time scales ranging from dynamic (~ms) to creep conditions (years) need to be investigated. Both monolithic materials as well as joints (between similar and dissimilar materials) need to be investigated. For experimental validation, continued use of fission reactor irradiations as well as a fusion-relevant irradiation source such as IFMIF or perhaps a tailored spallation neutron irradiation facility is needed.
- Effects of fusion-relevant irradiation on the sintering behavior and properties of tritium breeding and neutron multiplier materials. The mechanical behavior of breeder materials historically has been less studied compared to structural materials, including lithium-containing ceramics and beryllium compounds. A science-based approach to the sintering behavior of ceramic breeder pellets is needed to develop an accurate thermomechanical model of the integrated thermal conductivity and tritium release characteristics of the pebble bed concept. For experimental validation, continued use of fission reactor irradiations as well as a fusion-relevant irradiation source such as IFMIF or perhaps a tailored spallation neutron irradiation facility is needed.

**Gap:** Dimensional and phase stability and physical property degradation of materials in the fusion environment

### **Mission elements**

- Modeling and experimental validation of void swelling, irradiation creep and phase stability under fusion irradiation conditions. It is anticipated based on a limited number of ion beam irradiation studies and fledgling void swelling theory that the swelling resistance of the current leading fusion structural materials will be insufficient in the fusion environment due to swelling enhancement effects associated with the presence of He and H transmutant atoms. The effect of fusion irradiation conditions on the phase stability of structural materials is at an early stage of understanding, although H and He are expected to modify the radiation induced segregation behavior of solute

atoms. Improved understanding of the underlying physical phenomena that control void swelling, irradiation creep, and phase stability under fusion reactor conditions will enable the development of new nanoscale-engineered structural materials with superior performance. For experimental validation, continued use of fission reactor irradiations as well as a fusion-relevant irradiation source such as IFMIF or perhaps a tailored spallation neutron irradiation facility is needed.

- Effect of the fusion irradiation environment on thermal conductivity degradation mechanisms. The thermal conductivity is an important parameter for materials in a number of fusion systems, ranging from the structural materials to ceramic breeders to materials for plasma heating and diagnostics. Although it is generally known that neutron irradiation causes a degradation in thermal conductivity of materials due to formation of defect clusters and precipitates that cause deleterious scattering of the heat transport quanta (typically, electrons and phonons in metals and nonmetals, respectively), current models only provide qualitative predictions. A physically robust quantitatively predictive model of thermal conductivity degradation in the fusion environment is needed. For experimental validation, continued use of fission reactor irradiations as well as a fusion-relevant irradiation source such as IFMIF or perhaps a tailored spallation neutron irradiation facility is needed.
- Effect of the fusion irradiation environment on optical and electrical resistivity degradation mechanisms. The accuracy of several plasma diagnostic and control systems relies on knowing the electrical conductivity and optical properties of the constituent materials. Irradiation typically produces pronounced degradation in both the optical transmission and electrical resistivity of nonmetals. An improved understanding of radiation induced conductivity, radiation induced electro-motive forces, and optical property degradation is needed, particularly in cases where the current best available radiation-resistant optical materials are not sufficient for prolonged use in a fusion reactor. For experimental validation, continued use of fission reactor irradiations as well as limited testing in a fusion-relevant irradiation source such as IFMIF or perhaps a tailored spallation neutron irradiation facility is needed.

**Gap:** Science basis for robust high temperature structural design criteria

### **Mission elements**

- Development of a science-based methodology for safe operation of structural materials in a high temperature neutron irradiation environment. The licensing methodology currently used by the US Nuclear Regulatory Commission for light water fission reactors is limited to moderate temperatures (~300°C). The methodology used by governing engineering bodies such as ASME for safe operation of structures at high temperature is based on empirical testing of multiple products of a given material. This results in a costly and lengthy process to requalify any material when a minor compositional change is made, and inherently suppresses the development of new high-performance materials.

## Draft FESAC sub-panel report – Do not circulate

In particular, long-term mechanical fatigue, thermal creep and creep-fatigue tests (at different hold times and cyclic stress amplitudes) are currently required for any new high temperature structural material. Considering that fusion does not yet know what specific chemical formulation will be used for the structural materials in future fusion power plants, there is a clear advantage to develop an improved science-based method for qualifying structural materials for high temperature operation. A better fundamental understanding of the physical phenomena that control the mechanical behavior of structural materials at elevated temperatures is needed, particularly synergistic effects when multiple deformation processes (e.g., thermal creep and cyclic mechanical fatigue) are present. Most of the experimental validation can be performed on unirradiated materials. A few confirmatory tests on irradiated materials will also need to be performed using fission neutron, IFMIF, or perhaps spallation neutron source irradiated materials.

**Gap:** Chemical compatibility of materials in the fusion environment

### **Mission elements**

- Improve the scientific basis for chemical dissolution of solid materials exposed to high temperature coolants, with and without irradiation. The role of coolant velocity, chemical solubility in the coolant and other engineering factors on chemical dissolution are generally understood. However, the resulting fitted equations of experimental data often contain contradictory predictions due to the inappropriate grouping of data that are controlled by different physics/chemical phenomena. An improved understanding of the underlying processes, leading to a “chemical dissolution mechanism map” would be very useful for the development of quantitative predictive models. For the case of molten salt coolants, radiolysis events in the coolant produced by ionizing radiation can cause accelerated corrosion due to production of highly corrosive chemical radicals (e.g., HF or free fluorine). For liquid metal and helium gas coolants, the effect of radiation on the corrosion process is secondary in that the effect is mainly associated with radiation induced segregation processes in the bulk material.
- Understand the controlling phenomena involving chemical compatibility between adjoining solid materials, including the role of radiation enhanced diffusion.

**Gap:** Fabrication and joining of complex structures

### **Mission elements**

- Development of high-fidelity joining techniques for fusion-relevant materials and geometries. Based on a broad existing industrial experience base for joining of materials, it is understood that the most appropriate joining conditions are dependent on material, product form (e.g., joining of thin foil often requires entirely different techniques compared to plate or thick

sections), and service application (e.g., design stress at the joint, exposure to coolant, etc.). However, these joining conditions are typically developed as the result of a lengthy trial and error process, being largely dependent on the skill and knowledge of the lead welding engineer. The applicability to complex fusion structures of recently developed joining techniques such as friction stir welding and advanced ultrasonic joining processes should be assessed. The mechanical and physical properties of the joints, including effects of irradiation using fission reactors, IFMIF, or perhaps spallation neutron sources, need to be evaluated.

### 4.b.14. Safety and environment

DEMO will be a bridge between fusion specific safety considerations and Nuclear Regulatory Commission (NRC) type fission power plant safety regulation and licensing. ITER will validate design approaches and can demonstrate early lifetime reliability for fusion components at low dose (~0.3 dpa). The NRC is moving from the traditional worst case safety assessment to a probabilistic risk based safety approach. Since the nature of fusion hazards is different in type and magnitude compared to fission, we need to take advantage of those differences to avoid unnecessarily onerous regulations for fusion. For example, fusion safety should not depend on the components closest to the plasma (first wall or blankets), but should depend on engineered safety systems, e.g., vacuum vessel, cryostat, or building systems. The ITER safety strategy is based on such systems. Successful ITER operation will provide data for DEMO safety documentation and demonstrate the approach is viable. Never the less, several additional developments are needed for DEMO to be granted a license to operate.

#### **Gap:** Component qualification

Components for use in DEMO must be qualified to validate the design and demonstrate safety roles of key components are satisfied. Integrated testing of components in a high fluence fusion environment is needed to gather the data needed for component qualification. The data gathered will guide the choice of design codes (e.g., ASME section III or section VIII) used for fusion components. Simple acceptance of fission based codes is likely to lead to unacceptable restrictions on operations or unnecessary expense to meet safety margins that are not needed for fusion systems. DEMO designers need to develop what makes sense, demonstrate that the rules to be used are prudent, identify exceptions, and justify them. Data from an integrated component test facility will be essential for this process.

#### **Gap:** Safety Analysis and Source Terms

The US Fusion Safety Program has developed a series of system level computational tools to analyze the response of a fusion system to an off-normal event of accident. The underlying database needed to characterize the fusion radiological source term that could be mobilized is being gathered. Both the tools and the database will be improved by ITER operation, however it is likely that a thermal hydraulics transient test facility will be needed to validate key models

## Draft FESAC sub-panel report – Do not circulate

prior to a DEMO. This facility would not need to be full-scale, but could be a thermal hydraulically scaled divertor/blanket mockup. In particular, if DEMO is envisioned to include liquid metal components, a liquid metal loop would be needed. Key needs for DEMO include the need for integral off-normal behavior testing to validate the predictions of system behavior. Generation of dust in fusion systems is well known and has been characterized on several machines. During an accident there is a potential for a dust explosion. There are no tools for predicting dust explosions. If the potential for explosion on DEMO is severe enough there may be a need to provide a gas inerting system on DEMO. Verification and validation of the tools and supporting database are required for DEMO. In the long term, a new set of tools should be developed that take advantage of advances in computational science and our understanding of the basic science underlying transient behavior. These advanced tools (once validated and verified) can be used to reduce the margin associated with safety analysis, resulting in overall cost reduction.

### **Gap: Waste Management**

Fusion has long recognized that by using low activation materials for the blanket and divertor, the activation characteristics of those structures will not require that they be disposed of as high level waste. The radiological hazard of fusion waste is much less than fission waste. Fusion needs to take advantage of these differences by developing a complete waste management strategy in light of the anticipated more restrictive regulatory environment when DEMO operates. While the amount of high level waste can be minimized, the result is a significant amount of low level waste. The strategy should include waste reduction, recycling, and material clearance procedures. Fusion may have to develop techniques for detritiating waste prior to disposal or recycling. Development of guidelines for clearance of materials for release rather than disposal is just beginning and fusion needs to be involved in the process to assure the guidelines recognize unique needs and materials in fusion components.

### **Mission Elements:**

- Overall validated simulation of fusion systems
- Simulation and bench-top experiments to understand single-effect phenomena for fusion components
- Development of low activation materials and PFCs with low tritium retention and low rates of dust formation
- Development and validation of fusion components
- Integrated tests on CTF.

### **4.c. Discussion of overarching issues**

As the lists of issues and gaps were developed, a set of overarching technical issues arose which did not fit neatly into any of the broad research areas that we had identified. The

## Draft FESAC sub-panel report – Do not circulate

issues were: high availability, maintainability, reliability and economics. (Safety might also fit logically onto this list, but we felt that there were enough specific technical issues related to plant and public safety to call it out by itself.) These overarching issues describe general properties that would be required for a practical fusion reactor like Demo, but were not the special domain of any particular topical area or technical realm. They are characteristics which drive, implicitly or explicitly, much of the technical discussions in fusion science and would have to be designed into every part of a fusion reactor system. Each is an additional qualifier on the other technical requirements for fusion energy. At the same time, none are a dominant constraint on the current generation of experiments and are only weak drivers for the ITER design. However, as we consider the step to Demo, these issues become major requirements.

We should not underestimate the impact that these overarching issues have on our research programs. Though it will be decades before solutions are required, in many cases, these issues provide the context for all the others and focus our attention on a narrower set of approaches. Perhaps the most salient example is the focus on schemes and concepts which would allow continuous operation of fusion reactors. We clearly have in hand, the ability to run very long pulses without auxiliary drive. However, the engineering benefits, as measured against criteria such as availability, reliability and economics, clearly favor steady state. In another example, the interest in high-Z first walls is driven, in part, by concerns over erosion of other materials and the desire to increase the interval for first-wall maintenance. The hundred-fold increase in availability entailed in going from ITER to Demo requires that we develop a much better ability to predict erosion and redeposition rates from all parts of the first wall.

These overarching issues were not called out as separate questions because they are so intricately woven into the others. While dealing with them separately might appropriately raise their visibility, it might also cause us to overlook their importance as we define research requirements in other areas.

### **4.d. High-level organization of gaps**

The large set of fine granularity gaps discussed above were consolidated into a smaller set which emphasizes those with the greatest importance and the least likelihood of being resolved by current research. While this set of “Major” gaps, corresponds topically to most of broad questions outlined in chapter 2, the two lists should not be confused. The list of gaps has gone through the sieve of chapter 3 and what remains are the high-level gaps in our knowledge that will remain even after current programs complete their research. As mentioned before, this filtering is not an exact process. In many cases we weighed the uncertainty over whether a particular issue might be resolved against the consequence that it wouldn't be. That is, for now it is prudent to be somewhat pessimistic about the chance of solving some of the really critical questions.

What follows is a list of the consolidated major gaps with a brief description of the important elements of each.

## Summary of Major Gaps

G-1. Sufficient understanding of all areas of the underlying plasma physics to predict the performance and optimize the design and operation of future devices.

While the subject of much current and past research, it is likely that important areas such as turbulent transport and multi-scale, multi-physics coupling will require significant additional effort. Recent improvements in physical understanding, computational horsepower and numerical algorithms have been dramatic, but the complexity of the problem and the range of temporal and spatial scales suggest that there is no prospect of a first-principles solution by brute force. Coupling models across traditionally separate topical physics areas is an area of long-term research that will likely require decades of further work. It is worth noting that the diagnostic set for ITER and several of the other new initiatives are not sufficiently ambitious, in our view, to fully resolve these questions. Specific concerns in transport science include the ability to apply turbulence simulations on transport time scales; to predict the structure and stability of transport barriers, to understand electron, particle and momentum transport channels and to predict the dependences of transport on magnetic configuration including shape, aspect ratio and degree of internal/external magnetization. Also important is the precise prediction of stability boundaries in support of disruption avoidance.

G-2. Demonstration of integrated, steady-state, high-performance (advanced) burning plasmas, including first wall and divertor interactions.

The main challenge is combining high fusion gain with the strategies needed for steady-state operation. While the program has had remarkable success in achieving individual performance benchmarks, combining these requires reconciling somewhat contradictory requirements. For example, producing high-Q burning plasmas demands high absolute parameters, particularly pressure, while steady state is most easily achieved with high normalized parameters like  $\beta$ . Further, because of the demands for efficient current drive, steady-state tokamaks tend to be driven toward low density, below the optimum for producing fusion power and far below the most desirable conditions for compatibility with first wall and divertor designs.

G-3. Diagnostic techniques suitable for control of steady-state advanced burning plasmas which are compatible with the nuclear environment of a reactor.

The principle gap here is in developing robust measurement techniques which can be used in the hostile environment of a fusion reactor. The vessel and its surroundings will be subject to intense neutron and gamma bombardment excluding many of the techniques in use today. This limits what sorts of materials, optics and sensors are allowable. Further difficulties are imposed by the high temperature of the first wall, which will be held at temperatures in excess of 700C. The requirement for continuous operation at high availability will also challenge traditional approaches for calibration and testing of diagnostic systems. There is

## Draft FESAC sub-panel report – Do not circulate

also a need to develop innovative measurement techniques for non-nuclear devices which can be used to validate predictive simulations.

G-4. Control strategies for high-performance burning plasmas, running near operating limits, with auxiliary systems providing only a small fraction of the heating power and current drive.

In a high-Q burning plasma, almost all of the power and the current drive is generated by the plasma itself. Unlike current devices, external control will be at most perturbative. Innovative strategies must be developed to allow the creation of the sort of optimized profiles that lead to satisfactory performance. Possibilities include manipulation of the hydrogen isotope mix via deep fueling to control fusion power deposition; direct control of the pressure profile by manipulation of plasma transport, for example through RF flow drive; fine adjustment of the current profile with a minimal amount of external drive or control of the poloidal field by the addition of external helical windings. Overall control must be precise to avoid disruptions and other off-normal events and to minimize thermal excursions on first wall components.

G-5. Ability to predict and avoid or detect and mitigate off-normal events that could challenge the integrity of fusion devices.

For a tokamak to be viable as a fusion reactor, disruptions and other off-normal events must be reduced dramatically. Current understanding of the causes and dynamics of disruption is insufficient. It is also not possible to distinguish, by current measurements, the small differences that cause one discharge to disrupt while another similar discharge does not. For Demo, the requirement for virtually no full performance disruptions will require significant improvements in MHD models and in plasma measurement and analysis. Similarly, other off-normal events caused by large scale plasma instabilities, for example ELMs or fast-particle modes, must be understood and controlled.

G-6. Sufficient understanding of alternative magnetic configurations which have the ability to operate in steady-state without off-normal plasma events.

If high-performance tokamaks can not be made to operate efficiently in steady-state and without disruptions, alternative concepts will need to be advanced to fill the gap. These must demonstrate, through theory and experiment, that they can meet the performance requirements with sufficient reliability to extrapolate to a reactor. Along the way, they must demonstrate that they are free from off-normal events or other phenomena which would lower their availability or suitability for fusion power applications.

G-7. Integrated understanding of RF launching structures and wave coupling for scenarios suitable for Demo and compatible with the nuclear and plasma environment

The auxiliary systems typically used in current experiments, while extremely useful tools, are not generally suitable for a reactor. RF schemes are the most likely systems to be used and will require significant research to achieve the levels of reliability and predictability that are required. The stresses on launching



## Draft FESAC sub-panel report – Do not circulate

structures for ICRH or LHCD in a high radiation, high heat-flux environment will require designs which are less than optimal from the point of view of wave physics and which may require development of new materials and new cooling strategies. Validated models of coupled networks, antennas and wave physics will be needed along with strategies for coupling high power across the large gaps between the plasma and launching structures. Even with large plasma gaps the ICH or LHCD antennas will be basically flush with the First Wall and be subjected to the heat and electromechanical loading as other First Wall elements. However, they will also have to be compatible with the RF field environment, which puts additional limitations on material selection and mechanical support methodologies.

G-8. The knowledge base required to model and build low and high-temperature superconducting magnet systems that provide robust, cost-effective magnets (at higher fields if required).

Additional research will be required to improve predictive understanding of conductors, structures and insulators suitable for fusion magnets, allowing increased magnet performance and reduced costs and design margins. Critical issues include crack growth and damage in composite materials. This is particularly true for high-temperature superconductors which offer the possibility of operating at higher field but are a relatively new technology. Innovative fabrication techniques will be required to allow these materials to be used in fusion magnets. Quench detection and protection for high temperature superconductors is a significant problem as the propagation slows by about three orders of magnitude compared to low-temperature superconductors, challenging diagnostic systems.

G-9. Sufficient understanding of plasma-wall interactions to predict the environment for and behavior of plasma facing and other internal components for Demo conditions.

A predictive understanding of the plasma scrape-off layer (SOL) must be attained via improvements in modeling and experiments. These need to be focused on turbulence and cross-field transport which while poorly understood, is an important factor in determining SOL properties. As we move into the reactor regime, the mean free path for radiation and neutrals falls below characteristic machine scale lengths in many parts of the SOL plasma. The impact of this new physics needs to be verified and modeled. The science underlying the interaction of plasma and material needs to be significantly strengthened to allow prediction of erosion and redeposition rates, tritium retention, dust production and damage to the first wall. Strategies to mitigate impurity generation associated with RF sheaths need to be developed.

G-10. Understanding of the use of low activation solid and liquid materials, joining technologies and cooling strategies sufficient to design robust first-wall and divertor components in a high heat flux, steady-state nuclear environment.

Research into the basic properties of low-activation materials under high heat loads and simultaneous neutron bombardment must be carried out to develop and

## Draft FESAC sub-panel report – Do not circulate

qualify materials for reactor plasma facing components. Of particular importance is any modification of their heat conduction, tritium permeation and retention and the maintenance of their structural properties. The understanding and characterization of welds, brazes and other joining techniques, in the same hostile environment must also be significantly increased. Heat transfer across the joints and embrittlement from neutron damage and hydrogen permeation are particular concerns. Strategies for efficient heat removal at high temperatures with gas coolant must be developed. While liquid-surface first walls offer some relief from the challenges facing solid surface walls, the information required to employ them with confidence is almost entirely absent. There are major questions about the compatibility of the liquids with structures, MHD effects on moving conductors and contamination of the plasma by evaporation or sputtering. Innovative techniques to ensure sufficient mass flow to remove heat are required as temperatures must generally be kept low compared to solid first wall materials. Strategies for helium pumping must be developed.

G-11. Understanding the elements of the complete fuel cycle particularly tritium breeding and retention in vessel components.

Strategies for high-efficiency tritium breeding must be developed and tested. This includes the choice of breeding material and the basic thermal-hydraulic design. Breeding modules, capable of maintaining structural integrity at high temperatures in the presence of large neutron fluences must be developed. The throughput of tritium recovery and separation systems must be increased substantially to keep up with the fusion rates in continuously operating, reactor-scale devices. Methods for strict accounting of all tritium in the plant including permeation in components and piping must be developed along with approaches for eliminating long-term tritium retention in vessel components.

G-12. An engineering science base for the effective removal of heat at high temperatures from first wall and breeding components in the fusion environment.

Strategies for removing heat, at elevated temperatures with limited maintenance, from the blankets and first wall must be developed. Efficient and reliable methods for conversion of the heat in the high temperature coolant, including allowances for the unique role associated with tritium management issues, need to be developed and demonstrated on dedicated test stands.

G-13. Understanding of the evolving properties of low activation materials in the fusion environment necessary for structural and first wall components.

We must obtain a basic understanding of the behavior of relevant low-activation materials exposed to simultaneous fusion neutron irradiation, high heat fluxes, and substantial mechanical stresses over length scales ranging from atomic to macroscopic and time periods ranging from  $10^{-15}$  s to years. This will include the effects of materials chemistry and tritium permeation at high-temperatures. Important properties like dimensional stability, phase stability, thermal conductivity, fracture toughness, yield strength and ductility must be

## Draft FESAC sub-panel report – Do not circulate

characterized as a function of neutron bombardment up to very high levels of atomic displacement in a fusion-relevant environment.

G-14. The knowledge base for fusion systems sufficient to guarantee safety over the plant life cycle - including licensing and commissioning, normal operation, off-normal events and decommissioning/disposal.

Comprehensive models for fusion systems must be developed to support safety analysis and licensing. Especially important are accurate descriptions of system dynamics under off-normal events or accidents. Large scale fusion components must be qualified and experience gained with their remote handling. The generation and nature of dust produced in a fusion reactor must be characterized along with a predictive assessment of tritium content and release associated with that dust. Strategies to control and account for total tritium inventory must be developed along with plans for long term waste management and disposal.

G-15. The knowledge base for efficient maintainability of in-vessel components to guarantee the availability goals of Demo are achievable.

In order to achieve the desired availability of >50% for Demo, in-vessel components have to incorporate designs that, besides meeting all the performance requirements within a high neutron fluence environment, have lend themselves to quick change out when damaged. It would not be unreasonable to expect that this will require the development of special remote tooling for in-vessel component removal and re-installation, with the added need to perform inspection and quality control remotely. The invessel robotics must be capable of withstanding high radiation for extended periods of time. The material selected for joints or attachment points will have to be carefully chosen, with the expectation that multiple cutting and rewelding operations may take place.



## Chapter 5 New Facilities, Initiatives and Programs

In the previous chapter, we've outlined gaps in knowledge that will likely remain after current and planned research activities are complete. These gaps are provided at coarse and fine levels of granularity. Research activities, which could be undertaken to fill each of the fine-scale gaps, have also been described. Next, we identify a set of higher level initiatives and major facilities which consolidate these mission elements in a more integrated and coherent manner.

### 5.a. Synthesis

The list of proposed major initiatives came from consideration of knowledge gaps and U.S. opportunities. Each initiative represents an opportunity, with appropriate investment, for U.S. leadership in the world program. Most could be carried out with substantial international collaboration or could be led by an international partner with substantial U.S. involvement. Each makes a dominant contribution to at least one of the identified gaps and typically secondary contributions to several others. A sense of the priority of each initiative can be gained by considering the priorities of the issues and gaps that are addressed.

The initiatives and facilities listed, attack important research questions by breaking the problems into tractable pieces. Because of the strong coupling between issues, each is only an imperfect substitute for carrying out experiments on Demo itself - which can't be built until the research is complete, creating a logical impasse. The long-standing solution to the impasse, and the one we adopt here, is to augment research on major facilities, which approximate Demo in important ways, with basic research and a strategic and systematic program of modeling and validation. This approach provides the necessary scientific underpinnings and a strong basis for extrapolation. In general, a phased approach is required, beginning with theory, modeling and laboratory experiments, moving on to test stands or modest scale facilities and culminating in large-scale integrated experiments. More details on these multi-phase strategies are provided in section 5.c.

In some cases more than one initiative is listed to address a particular gap. For example, a major effort to enhance the advanced tokamak program on ITER has a similar goal as a new major facility aimed at investigating the same science. One of these would be necessary, in our judgment, to provide the information required to go forward with a Demo based on AT physics. The choice between the alternatives would be based on technical, political and economic factors. It may be possible to combine the missions

two or more of the facilities listed below into a single larger initiative, though only after careful consideration of costs and benefits. For example, the main requirement for a component qualification facility is to provide continuous, steady and predictable nuclear operation which may be at odds with a plasma physics research mission.

### **5.b. Table of possible major initiatives, facilities and programs**

#### I-1. Initiative toward predictive plasma modeling and validation

This activity describes a coordinated program which would combine major advances in advanced physics based plasma simulations, especially multi-scale, multi-physics issues combined with a vigorous effort to validate these models against large and small-scale experiments. A critical element would be the development and deployment of new measurement techniques.

#### I-2. Extensions to ITER AT capabilities

This initiative would entail new or enhanced drivers (heating, current drive, etc.), control tools and diagnostics capable of carrying out a comprehensive AT physics program. The aim would be to achieve an understanding of burning AT regimes sufficient to base Demo on.

#### I-3. Integrated advanced burning physics demonstration

This facility would be a dedicated sustained, high-performance burning plasma experiment with a goal to achieve an understanding sufficient to base Demo on. It is predicated on the condition that extensions to the ITER AT program and predictive understanding from the international superconducting tokamaks will not achieve an understanding sufficient for extrapolation to Demo.

#### I-4. Integrated experiment for plasma wall interactions and plasma facing components

This very-long pulse or steady-state confinement experiment would perform research on plasma wall interactions and plasma facing components in a non-DT integrated facility. It would attempt to duplicate and study, as closely as possible, all of the issues and (non-nuclear) problems that PWI/PFCs would face in a reactor.

#### I-5. Advanced experiment in disruption-free concepts

This would be a performance extension device for a concept that had demonstrated promise for fusion applications by projecting to high performance and efficient steady state, and which was significantly less susceptible to off-normal events compared to a tokamak. A stellarator would be the mostly likely candidate for such a facility.

#### I-6. Engineering and materials physics modeling and experimental validation initiative

This would be a coordinated and comprehensive research program consisting of advanced computer modeling and laboratory testing aimed at establishing the single-effects science for major fusion technology issues, including materials, plasma-wall interactions, plasma-facing components, joining technologies, super-

## Draft FESAC sub-panel report – Do not circulate

conducting magnets, tritium breeding, RF and fueling systems. While existing facilities could be used for this initiative, construction of new ones would be required as well. (This effort would enable items I4, I8, I9, and possibly I3.)

### I-7. Materials qualification facility

This initiative would involve testing and qualification of low-activation materials by intense neutron bombardment. The facility generally associated with this mission is the International Fusion Materials Irradiation Facility (IFMIF). The potential for a dedicated spallation neutron source irradiation facility to reduce or possibly eliminate the need for the US to participate as a full partner in IFMIF needs to be assessed.

### I-8. Component development and testing program

This would entail coordinated research and development for multi-effect issues in critical technology areas. Examples are breeding/blanket modules and first wall components but this initiative could include other important components like magnet systems or RF launchers. This program would most likely be carried out as enabling research in direct preparation and support of planned nuclear fusion facilities such as ITER, CTF or Demo.

### I-9. Component qualification facility

This facility is aimed at testing and validating plasma and nuclear technologies in a high availability, high heat flux, high neutron fluence DT device. It would qualify components for Demo and establish the basis for licensing. In fusion energy development plans, this machine is called a Component Test Facility (CTF).

## 5.c. Relation of initiatives to gaps

The potential for each initiative to fill identified gaps is summarized in figure 5.1. The chart is meant to illustrate graphically, the level of contribution that each initiative or facility makes toward each of the gap areas. A complete program leading toward Demo could be developed by choosing a set of the initiatives listed sufficient to fill every gap. The U.S. program would need to decide which initiatives to lead and which to collaborate or participate in. In the following section, the strategy and logic for filling each gap is described. This includes a discussion of alternate paths, important dependencies and sequencing.

*G-1. Sufficient understanding of all areas of the underlying plasma physics to predict the performance and optimize the design and operation of future devices.*

This gap is addressed by a combination of theory/model development and experimental validation. The principal tool is initiative 1 (I1) an extensive program of validation on a wide range of experimental facilities and extension of fundamental theory and modeling to address the relevant multi-scale, multi-physics issues. Development of and deployment advanced diagnostics are

## Draft FESAC sub-panel report – Do not circulate

considered part of I1. This gap also benefits from increases in knowledge of plasma physics (I2-I5), particularly those in the burning plasma range (I2, I3).

*G-2. Demonstration of integrated, steady-state, high-performance (advanced) burning plasmas, including first wall and divertor interactions.*

This gap could be addressed by either enhancements of ITER capabilities (I2) supporting an extensive AT program, or if that is not feasible, by construction of a new burning plasma device (I3). It also benefits from development of improved plasma models (I1) which would be carried out in advance and concurrently with the experiments.

*G-3. Diagnostic techniques suitable for control of steady-state advanced burning plasmas which are compatible with the nuclear environment of a reactor.*

This gap could be filled by development and testing of diagnostics on any of the proposed burning plasma experiments (I2, I3, I9). The requirement for success is that the diagnostics survive in the fusion environment and are capable of providing the measurements needed for control in the advanced regimes needed for Demo.

*G-4. Control strategies for high-performance burning plasmas, running near operating limits, with auxiliary systems providing only a small fraction of the heating power and current drive.*

This gap could be filled by research into control strategies on high-Q burning plasma experiments (I2, I3). It is supported by development of predictive plasma models (I1).

*G-5. Ability to predict and avoid or detect and mitigate off-normal events that could challenge the integrity of fusion devices.*

Filling this gap requires a sequence of steps. First would come development and validation of models which can reliably describe the multi-physics effects associated with disruptions, ELMs and other off-normal plasma events (I1). These models would be combined with strategies developed on current and planned experiments and extended and tested on long-pulse, low duty-cycle high-Q plasmas (I2, I3). These strategies could then be applied to continuous, high duty-cycle burning plasmas (I9).

*G-6. Sufficient understanding of alternative concepts which have the ability to operate in steady-state without off-normal plasma events.*

This gap represents a possible alternative to solving the disruption and ELM problems on a tokamak. It would be filled by experiments which succeed in demonstrating operation free of off-normal plasma events simultaneous with performance that could be extrapolated to a Demo (I5). Development of validated plasma models would help provide the necessary underpinnings for this line of research (I1).



## How Initiatives Could Address Gaps

### Legend

Major Contribution	3
Significant Contribution	2
Minor Contribution	1
No Important Contribution	

	G-1 Plasma Predictive capability	G-2 Integrated plasma demonstration	G-3 Nuclear-capable Diagnostics	G-4 Control near limits with minimal power	G-5 Avoidance of Large-scale Off-normal events in tokamaks	G-6 Developments for concepts free of off-normal plasma events	G-7 Reactor capable RF launching structures	G-8 High-Performance Magnets	G-9 Plasma Wall Interactions	G-10 Plasma Facing Components	G-11 Fuel cycle	G-12 Heat removal	G-13 Low activation materials	G-14 Safety	G-15 Maintainability
I-1. Predictive plasma modeling and validation initiative	3	2		2	2	3	1		2						
I-2. ITER – AT extensions	3	3	3	3	3		2	2	2	2	1	1		1	1
I-3. Integrated advanced physics demonstration (DT)	3	3	3	3	3	1	3	2	3	3	1	1	1	1	1
I-4. Integrated PWI/PFC experiment (DD)	2	1		1	2		2	1	3	3	1	1		1	1
I-5. Disruption-free experiments	2	1		2	1	3		1	1	1					
I-6. Engineering and materials science modeling and experimental validation initiative							1	3	1	3	2	3	3	2	1
I-7. Materials qualification facility							1			3	2	1	3	3	
I-8. Component development and testing			1				2	1		3	3	3	2	2	2
I-9. Component qualification facility	1	1	2	1	2		3	2	2	3	3	3	3	3	3

Fig. 5.1. To what extent does each proposed initiatives (rows) address the important gaps (columns)

*G-7. Integrated understanding of RF launching structures and wave coupling for scenarios suitable for Demo and compatible with the nuclear and plasma environment.*

This gap could be filled by research on any of the proposed burning plasma experiments (I2, I3, I9). New experiments may be somewhat more valuable as they could allow more flexibility than those constrained by the frozen design on ITER. This gap would also benefit from a facility designed for development and testing of large components in a nuclear environment (I8).

*G-8. The knowledge base required to model low and high-temperature superconducting magnet systems in order to provide robust, cost-effective magnets (at higher fields if required).*

This gap would be filled by first initiating a program of basic research and computational model development and laboratory testing (I6). The next step would be design of high-performance magnet systems for new fusion experiments (I3, I9) and Demo itself.

*G-9. Sufficient understanding of plasma-wall interactions to predict the environment for and behavior of plasma facing and other internal components for Demo conditions.*

This gap would be filled by a multi-step, multi-faceted program. The first step would be development of edge plasma models (I1) and plasma-wall models (I6) including comparison with laboratory test stands and confinement experiments. As the only DT device currently planned, ITER would play an important role in this research. A non-burning experiment might provide a bridge to nuclear facilities by developing understanding and by providing a flexible test-bed for new ideas (I4). These models could be refined by research on advanced burning plasma experiments (I2, I3) and a continuous, high-fluence nuclear testing device (I9)

*G-10. Understanding of the properties of low activation solid and liquid materials, joining technologies and cooling strategies sufficient to design robust first-wall and divertor components in a high heat flux, steady-state nuclear environment.*

This gap is filled in a similar manner to G9 with the addition of a staged program of materials research and component development (I6), materials testing and qualification in a fusion-relevant environment (I7) and component testing (I8) with proof tests on an advanced burning plasma experiment (I3) and a fusion reactor component test facility (I9).

*G-11. Understanding the elements of the complete fuel cycle particularly tritium breeding and retention in vessel components.*

This gap also requires a staged approach. The first step would be a research program, involving both laboratory experiments and computer simulation, into

neutron transport and breeding, thermal hydraulics of breeding and cooling fluids and a host of other issues (I6). This program might include participation in the TBM program on ITER. Knowledge gained in this research would be applied next to component development and testing (I8) and qualification (I9).

*G-12. An engineering science base for the effective removal of heat at high temperatures from first wall and breeding components in the fusion environment.*

The strategy to fill this gap would be similar to that for G11 except that a different set of engineering problems would need to be addressed, in particular establishment of viable techniques to reliably and efficiently convert the heat from high temperature coolants to electricity with limited maintenance needs. The tritium extraction and processing methodology needs to be fully compatible with the energy extraction and conversion processes.

*G-13. Understanding of evolving properties of low activation materials in the fusion environment relevant for structural and first wall components.*

This gap would be filled by a multi-step program. The first step would be identification of promising materials through the development of multi-scale models for fusion relevant materials and basic materials science research (I6). Selected materials would be tested with fission neutron sources or spallation sources (I6). The next step would be to develop and qualify a very small number of the most promising materials in a materials qualification facility such as IFMIF (I7). These materials would then be built into components and tested (I8) and then qualified in a continuous burning plasma facility (I9).

*G-14. The knowledge base for fusion systems sufficient to guarantee safety over the plant life cycle - including licensing and commissioning, normal operation, off-normal events and decommissioning/disposal.*

Gaps in safety and environmental knowledge would be filled by a long term program of modeling and basic research (I6) and would follow closely the development of fusion components and system (I7). The component qualification facility (I9) would represent a synthesis of previous research and a demonstration of safe and environmentally benign fusion energy.

*G-15. The knowledge base for efficient maintainability of in-vessel components to guarantee the availability goals of Demo are achievable.*

Gaps in maintainability would be filled by a broad program on ITER and any future DT or long-pulse DD devices. The component qualification facility (I9) would represent the best opportunity to demonstrate design, materials choices, fabrication techniques and strategies for assembly that were all consistent with maintainability and remote handling, if it uses similar approaches as those selected for Demo.

## **5.d. Resource Requirements And Risk Management**

No attempt was made to cost out the initiatives listed above in section 5.b, however it is clear that all will require major investments. The component qualification facility and the advanced burning plasma experiment would likely rival all fusion facilities, excepting ITER, in cost. The panel is not unaware of the challenge in arranging funding for such large endeavors.

It was not within our charge to develop a detailed strategy for fusion energy development, however we think it is worth noting some of the considerations which would go into a plan based on the work presented here. A comprehensive plan would be organized to fill all of the gaps discussed in chapter 4 taking cognizance of the risks inherent in developing any new science and technology. The main risk faced is delay in deployment of fusion energy due to unforeseen technical difficulties in carrying out the plan, to costs which make the first generation of fusion reactors economically uncompetitive or to insurmountable problems along the development path chosen. At some point delay is equivalent to failure, as government and industry conclude that no solution will be forthcoming. That is, a program carried out so slowly and deliberately as to never make a wrong step may carry more risk than one which tries to move more boldly and accepts that it will make some mistakes and follow some blind paths. The principle strategy to mitigate risk is to implement a sufficiently broad program so that alternative approaches or technologies are available at each step.

Any research program, no matter how carefully planned may not provide the information or knowledge at the time it is needed to take the next logical step in development. One goal of a strategic plan for fusion would be to maximize the chance that the required information is available by providing deep scientific foundations for the necessary disciplines and by following alternate research paths where uncertainties are greatest. It is clear that there is a direct trade-off between risks and costs and that budgets will always require making choices about which lines of research to follow. One important set of choices for the U.S. program involves deciding which issues to address through international collaboration and which to take on itself. Clearly the U.S. will be working with and relying on foreign programs for the foreseeable future, however, maintaining some level of core competency in all relevant technical areas is probably a prerequisite for effective partnership and a necessity if the U.S. aspires to leadership in fusion energy development in the future.

## Appendices

### A. Charge Letter



#### Under Secretary for Science

Washington, DC 20585

February 7, 2007

Professor Stewart C. Prager, Chair  
Fusion Energy Sciences Advisory Committee  
Department of Physics  
University of Wisconsin  
1150 University Avenue  
Madison, Wisconsin 53706

Dear Professor Prager:

On November 21, 2006, the U.S. signed the ITER Agreement. This event signals a new era in fusion, where access to fusion burning plasmas will be available for the first time. This will involve an unprecedented level of international cooperation. The United States must have a robust, world-class domestic program to support our involvement with the international fusion community, and fully exploit the expected scientific and technical breakthroughs from ITER. It is recognized that ITER, by itself, will not provide answers to all of the scientific and technical issues that are required for the promise of fusion to be realized.

The fusion community met in Snowmass in the summer of 2002 where a consensus was reached that it was time to pursue a sustained burning plasma experiment, namely ITER. A subsequent FESAC report and the National Research Council of the National Academies of Science affirmed that community consensus. These studies will continue to inform decisions made within the Office of Fusion Energy Sciences. A feature of the community studies is that the U.S. involvement in ITER should constitute the penultimate step to consideration of a fusion Demonstration Power Plant (DEMO) in the United States.

To assist planning for the ITER era, it is critical that FESAC identify the issues arising in a path to DEMO, with ITER as a central part of that effort. Therefore, I ask that FESAC 1) identify and prioritize the broad scientific and technical questions to be answered prior to a DEMO; 2) assess available means (inventory), including all existing and planned facilities around the world, as well as theory and modeling, to address these questions; and 3) identify research gaps and how they may be addressed through new facility concepts, theory and modeling.

This is the first of two charges to FESAC—a second charge will be issued asking FESAC to develop a long-term strategic plan. This charge will ask that the plan include a specific pathway to DEMO within the context of the broader Office of Science Strategic Plan, as well as other program elements needed in a comprehensive strategic plan for fusion research. The effort of developing this strategic plan should build on the results of this first charge. This approach should allow FESAC to keep its response to this current charge at the conceptual level while reserving more detailed considerations to the results of the second charge. I ask that FESAC be mindful of this concept while preparing its response to this charge.

Please respond to this charge by October 1, 2007.

Sincerely,

A handwritten signature in cursive script that reads "Raymond L. Orbach".

Raymond L. Orbach  
Under Secretary for Science

## **B. Panel Roster**

Martin Greenwald (chair) – MIT Plasma Science & Fusion Center

Richard Callis - General Atomics

David Gates - Princeton Plasma Physics Laboratory

Bill Dorland - The University of Maryland

Jeff Harris - Oak Ridge National Laboratory

Rulon Linford -Lawrence Livermore National Laboratory

Mike Mauel - Columbia University

Kathryn McCarthy - Idaho National Laboratory

Dale Meade - Princeton University, Plasma Physics Laboratory (Retired)

Farrokh Najmabadi - University of California San Diego

Bill Nevins - Lawrence Livermore National Laboratory

John Sarff - University of Wisconsin

Mike Ulrickson - Sandia National Laboratories

Mike Zarnstorff - Princeton Plasma Physics Laboratory

Steve Zinkle - Oak Ridge National Laboratory

## **C. Panel Process and Meetings**

In addition to 15 conference calls and innumerable emails, the panel met face to face three times. These were:

5/30-31 2007 at the University of Maryland conference center in College Park

6/25-27 2007 at General Atomics in San Diego, California

8/7-9 2007 at Princeton Plasma Physics Laboratory in Princeton, New Jersey

The first day of the June and August meetings were devoted to workshops for community input. In addition, comments and white papers were solicited through an online bulletin board. 60 White papers were submitted. A total of 90 members of the fusion community were registered for the bulletin board.

Lists of white papers and presentations at the community workshops are included below along with links to these documents. These will be maintained online for at least five years.

## D. Community White Papers

Links to White Papers can be found at: <http://www.psfc.mit.edu/~g/spp/whitepapers.html>

M. Abdou – A Research Program for Fusion Nuclear Sciences  
D.B. Batchelor -The Fusion Simulation Project  
L.R. Baylor - Fueling and Disruption Mitigation Issues to Proceed with Demo  
P.T. Bonoli – Steady State Issues for Demo  
A.H. Boozer – Importance of QA Extensions to Tokamak Operating Space  
T. Burgess – Nuclear Component Testing: Remote-Handling  
L. Cadwallader – Nuclear Component Testing: Regulatory-Issues  
L. Cadwallader - Nuclear Component Testing: Safety-Issues  
S.O. Dean – Pilot Plant: An affordable Step Toward Fusion Power  
L. El-Guebal - Nuclear Component Testing: Tritium-Sufficiency  
T.E. Evans – Edge Localized Mode and Pedestal Control Using RMP Coils  
J.R. Ferron – Stability Control at High  $\beta_N$   
J. Freidberg – Fission-Fusion Hybrids  
G. Fu – Energetic Particle Physics in Burning Plasmas: ITER to Demo  
R. Goldston – Implications of the FESAC Fusion Development Plan Study  
T.S. Hahm – Outstanding Issues in Transport Physics for Demo  
D. Hill – Power and Particle Control in High Performance Plasmas  
A. Hoffman – Complementary Engineering-Based Program for Fusion Reactor Optimization  
J. Holder - Nuclear Component Testing: Tritium Retention and Accountability  
D. Humphreys – Reactor Control  
J. Kesner - short-Term-Missions for Fusion – Fissile Fuel Breeding  
B. Lipschultz – First-Wall Materials Issues for Demo  
T. C. Luce – Profile Control Issues and Metrics  
J. Lyon – The Compact Stellarator Approach to Demo  
R. L. Miller – Fusion Demo Considerations  
N. Morley - Nuclear Component Testing: First-wall, Blanket and Divertor Reliability  
M. Ono – An ST Fusion Development Path  
M. Peng - Nuclear Component Testing  
T. Petrie – Power and Particle Control in High Performance Plasmas  
D. Petti – Environmental, Safety and Health Needs for Demo  
C. Petty – Transport Under Reactor Conditions  
P.A. Politzer – High Beta Steady-State Tokamak Operations  
M. Porkolab – General Comments on U.S. Demo Readiness  
S. Prager – Demo and ITER Support Through a Second Burning Plasma Experiment



R. Prater - Heating and Current Drive Under Reactor Conditions  
R. Raman - Requirements for an Advanced Fuelling System  
A. Reiman – Stabilization of the Vertical Mode in Tokamaks by Localized Nonaxisymmetric Fields  
D.N. Ruzic – The Case for Liquid Lithium  
J. H. Schultz – A Magnet R&D Program Required for Demo  
C.H. Skinner – Dust Management  
C.H. Skinner – Tritium Retention  
C.H. Skinner – Tungsten Plasma Facing Components  
L. Snead - First-wall, Blanket and Divertor Material Defects Control  
J. Snipes-Burning Plasma Control  
W.M. Stacey - Paths to Demo  
R. Stambaugh – A Fusion Development Facility  
P. Stangeby – Impurity and Tritium Control: Fusion PFC Materials  
T. Strait – Disruption-free High-Performance Operation  
D. Stutman – Development of Sensors and Light Extractors for Demo  
J. Terry – Diagnostic and Control Capabilities Beyond ITER  
G.R. Tynan – Integration of Demo-Relevant PFCs with Demo Core Plasma  
M.R. Wade – Steady-State, High Power Density Tokamak Operation  
J. Wesley – Criteria for Starting on Demo  
C. Wong – Reactor Maintainability  
C. Wong – Tritium Breeding Ratio  
C. Wong – Materials Lifetime in Fusion Reactors  
S. Wukitch – RF Heating and Current Drive Systems  
K.M. Young – Issues for Demo Diagnostics  
L.E. Zakharov – LiWall Fusion

## **E. Community Workshops and Presentations**

### **First Workshop**

**6/25/2007 at General Atomics, La Jolla, Ca**

Presentations are available at: <http://www.psfc.mit.edu/~g/spp/june-agenda.html>

Magnet technology - Miklos Porkolab/Joe Minervini

PFC materials - George Tynan

Heat flux control - David Hill

ELM and pedestal control - Todd Evans

Plasma materials interactions - Jon Menard/Rob Goldston

Fusion development issues - Ron Stambaugh/Vincent Chan

Tritium breeding - Clement Wong

Steady state at high  $\beta$  - Mickey Wade

Profile control/plasma control - Tim Luce

Stability control at high  $\beta$  - John Ferron

Disruption avoidance and mitigation - Ted Strait

Diagnostics for DEMO - Rejean Boivin

Core and pedestal transport with  $T_e = T_e$  and low  $v^*$  - Craig Petty

Fusion nuclear science and technology R&D needs - Mark Tillack

### **Second Workshop**

**8/7/2007 at Princeton Plasma Physics Laboratory, Princeton, NJ**

Presentations are available at <http://www.psfc.mit.edu/~g/spp/august-agenda.html>

Scientific and Technical Challenges for Demo Materials Development - Kurtz

First wall issues – D. Whyte

Tritium retention and dust – C. Skinner/Gentile

The Case for Liquid - Lithium Ruzic

Li wall fusion – L. Zakharov

Requirements for an Advanced Fueling System – R. Raman  
An ST Fusion Development Path – M. Ono  
Quasi-axisymmetric Extension of Tokamak Operating Space – A. Boozer  
Compact Stellarator Approach to Demo – J. Lyon  
Beyond ITER: RF Heating and Current Drive Issues for Demo – C.K. Phillips  
RF Heating and Current Drive Systems – S. Wukitch, M. Porkolab  
Input on Steady State Issues for Demo – P. Bonoli  
Fission/fusion hybrids – J. Freidberg  
Paths to a Fusion Demo – S. Dean  
Remote handling - Burgess  
Blankets and divertors - Morley  
A case for a facility to rapidly advance the CT concept – T. Jarboe  
Energetic Particle Physics in Burning Plasmas - Fu/Gorelenkov  
Outstanding Issues in Transport Physics – T.S. Hahm  
Nuclear Component Testing issues – M. Peng  
Implications of the FESAC fusion development path study – R. Goldston